

DynaPak Gas Sampler

S Y S T E M S U P P O R T M A N U A L

DP-2010TP



DP-2010TP

INSTRUCTION & OPERATING

MANUAL

Version: 10012004

DP-2010 TP TABLE OF CONTENTS

DP-2010 TP Table of Contents	I
Section 1: First Things To Know	1
How to Use this Manual	1
Typographic Conventions	1
Getting Help	1
Operation Specifications	2
Theory of Operation	3
System Accessories	4
Section 2: System Installation	5
Standard System Components	5
System Flow Schematic	6
Standard System Mounting	7
Standard System Connections	8
Optional DPS-2 Installation	9
Section 3: Sample Vessel Installation	11
Variable Pressure/Constant Volume Cylinders	11
Link Plus	11
Section 4: System Control & Electronics	13
Overview	13
Section 5: Programming for Proportional-to-Flow Operation	15
Setting Operator Input Parameters	15
Section 6: Programming For Proportional-To-Time Operation	19
Setting Operator Input Parameters	19
Section 7: Programming For Proportional-To-Time w/DPS-2 Operation	23
Setting Operator Input Parameters	23
Section 8: Mechanical System	27
DP-2000 Sample Pump	28
YZ Filter Regulator	29
Section 9: System Operation	31
Preparing The System For Operation	31
Electric Heater Operation	32

Section 10: System Maintenance	35
Preventative Maintenance Schedule	35
Monthly Inspection	35
Semi-Annual Inspection	35
Annual Inspection	35
Recommended Spare Parts	35
Cleaning and Lubricating The Pump	36
Replacing a Depleted Battery	38
Section 11: System Troubleshooting	41
How to Use This Section	41
For Additional Help	41
Step-by-Step Resolution	41
Battery Power	42
Battery Power Troubleshooting Steps	42
Z-65 Counter Mode	43
Z-65 Counter Mode Troubleshooting Steps	43
Z-65 Timer Mode	44
Z-65 Timer Mode Troubleshooting Steps	45
Appendix A: Illustrations	49
DP-2000 Sample Pump Assembled	49
DP-2000 Sample Pump, Exploded View	50
Filter Regulator, Assembled	51
Filter Regulator, Exploded View	52
Link Plus	53
Optional DPS-2	54
Z-65 and Solenoid	55
Z-65 Wiring Control Document	56
Electric Heater	57

SECTION 1: FIRST THINGS TO KNOW ABOUT THE DYNAPAK

How to Use this Manual

The DP-2010 Operations Manual is a step-by-step guide containing the procedures needed to work with the DP-2010 System.

The DynaPak System Series of samplers implement the most advanced technology available in the industry. It is recommended that the technicians working with the DynaPak Systems study the manual prior to initiating work on the system for the first time.

Typographic Conventions

To aide in readability, this manual uses several typographic conventions. References to illustrations, photographs, and other related content will appear in *italicized text* along with the location of where to find the item in the manual. Digital versions of the manual, available in Adobe Acrobat™ PDF format, will be highlighted further in *blue italic text* indicating the copy retains a hyperlink to the referenced item.

Measurement units are listed in italic parenthesis text following their US standard equivalent. As an example, for defining a distance, 15' (*4.5 meters*), is how the text will appear throughout the manual.

Items that require action, for example the pressing of a key for programming the controller, will feature the action item in sentence case **Bold Text** followed in normal text by the item such as, the **Up Arrow** key or **Main Power** switch.

Getting Help

This manual provides solutions to typical questions about the DP-2010 system. If the answer can not be found within this manual, contact YZ Systems at:

T: 1.936.788.5593

T: 1.800.653.9435

F: 1.936.788.5720

Em: Service@yzhq.com

When calling, have this manual close at hand. Whether calling or writing, please include in your communicate the following information:

- The serial number of the DynaPak System and the version number of this manual. The serial number is located on the inside of the enclosure door. The version number of this manual is located at the bottom of each page.
- A description of the problem and, if applicable the actions of the technical personnel when the problem occurred.

SECTION 1: FIRST THINGS TO KNOW ABOUT THE DYNAPAK

Operation Specifications

Maximum Output:	5,760 cc/day* (5.76 liters/day)
Maximum Operating Pressure:	1,500 psig (124 Bar (g))
Pump Displacement:	.2 - .4 cc/Stroke
Operating Temp Range:	0 to 140 degrees F. (17°C to 60°C)
Power Supply:	Internal Battery Pack*
Flow Signal	Dry Contact or Voltage Pulse
Electric Heater	Voltage 120 VAC

* The **External Power Option** can be used in lieu of the internal battery pack. The External Power Option (model # EPO-120) consists of an AC to DC convertor and intrinsically safe barrier to convert 120 VAC power to 28 VDC to operate the controller without the use of the internal battery pack.

SECTION 1: FIRST THINGS TO KNOW ABOUT THE DYNAPAK

Theory of Operation

The DynaPak DP-2010TP Sampler is a pipeline mounted system which uses the pneumatically operated, positive displacement DynaPak 2000 pump, the Z-65 timer/controller, the YZ filter/regulator and a low power solenoid valve to obtain gas samples, while utilizing a catalytic heated enclosure to aid in preventing the sampled product from going through a phase change, as temperatures, and pressures vary.

The 2010 provides three modes of operation:

A. Time-based sampling: in this mode of operation, the 2010 extracts a gas sample from the pipeline at regular time intervals. The volume of the sample is set by the operator using the volume adjustment feature of the DP-2000 pump. The Z-65 controller operates as a recycling timer, periodically energizing a low power solenoid valve. Energizing the solenoid valve allows actuation gas to stroke the DP-2000 pump. The rate at which this occurs is a function of operator input. Two 10 position switches are used to set the off time interval. The number of times the solenoid output is activated is recorded by the onboard LCD stroke indicator.

B. Time-based sampling with the YZ differential pressure switch (DPS-2): this mode of operation is similar to the time-based sampling mode, except that the DPS-2 converts a differential pressure signal to an electrical signal that the Z-65 timer uses to determine if flow is present in the pipeline. In effect, the DPS allows the Z-65 timer to shut off when flow stops in the pipeline, and when flow starts again, the ability to start-up and resume operation.

C. Proportional-to-flow sampling:

in this mode of operation, the Z-65 counter operates as a dividing counter. The Z-65 counter periodically energizes a low power solenoid valve. As in the other two modes of operation, this allows actuation gas to stroke the DP-2000 pump. The rate at which this occurs is a function of operator input as well as the host computer or other device that inputs pulses per volume metered. The two 10-position switches on the Z-65 are used to set the number of pulses the counter will count before activating the solenoid output. The number of times the solenoid output is activated is recorded by the onboard LCD stroke indicator. Sample volume is again controlled using the DP-2000 volume adjustment knob.

In all three modes of operation, the Z-65 timer/counter operates using a replaceable internal battery pack. The battery pack condition is monitored by way of two indicator LEDs. When the battery pack needs replacement, the red LED will illuminate when the solenoid output is activated. If the battery pack is good, the green LED will illuminate when the solenoid is activated.

SECTION 1: FIRST THINGS TO KNOW ABOUT THE DYNAPAK

System Accessories

- The **External Power Option** can be used in lieu of the internal battery pack. The External Power Option (model # EPO-120) consists of an AC to DC convertor and intrinsically safe barrier to convert 120 VAC power to 28 VDC to operate the controller without the use of the internal battery pack.
- The **Solar Power Option** would be used in lieu of the internal battery pack. The **Solar Power Option** (model #SPO-12) consists of a 5 watt solar panel with RM-12 charger regulator module and internal 12V, 5 Amp hour battery pack.
- **SC-Spun Vessel**, portable DOT approved (1800 psi maximum working pressure), sample vessels. Available in 300, and 500 cc sizes.
- **KK-1, KK-2, & KK-3**: carrying cases that meet DOT requirements for transporting portable sample vessels.
- 1/4" stainless steel tubing **Dielectric Isolator Union**. These should be installed in every tubing line that attaches the sampler to the pipeline in any manner. For example the supply gas, product connection to the system, and differential pressure switch connections, (P/N A1-0182).
- **DPS-2** differential pressure switch for applications with flow.no-flow conditiona and no flow signal available.
- **LinkPlus** provides a direct link between the DynaPak, and your sample vessel, providing a guage, vessel isolation valve, and excess pressure protection.

A complete line of sampling accessories ranging from sample probes to sample vessels is available through YZ. Please contact your local representative or YZ toll free at 800.344.5399. For technical support call 800.653.9435.

SECTION 2: SYSTEM INSTALLATION

Standard System Components

Standard primary components of the DynaPak 2010 include the following:

- **System Enclosure**, *figure 1 & 2*. Houses the Sample Pump, Filter Regulator, Solenoid, Spun Cylinder Sample Vessel, Catalytic Heater, and Temperature Gauge.
- **Sample Pump**, *figure 2*. Probe mounted, pneumatically actuated DP-2000 Sample Pump.
- **Filter Regulator**, *figure 2*. Stainless Steel regulator capable of reducing pressure from line pressure of up to 1500 psi down to system supply pressures in one step.
- **Low Power Solenoid**, *figure 2*. provides interface between the Z-65 Electronic Controller, and the Pump Pneumatic actuation.
- **Z-65 Controller Enclosure**, *figure 1*, Provides a weathertight enclosure for the Z-65 controller.
- **Z-65 Controller**. *figure 1*. Provides control functions for the DynaPak Sampler in Proportional-To-Flow, or Proportional-To-Time Modes.

figure 1

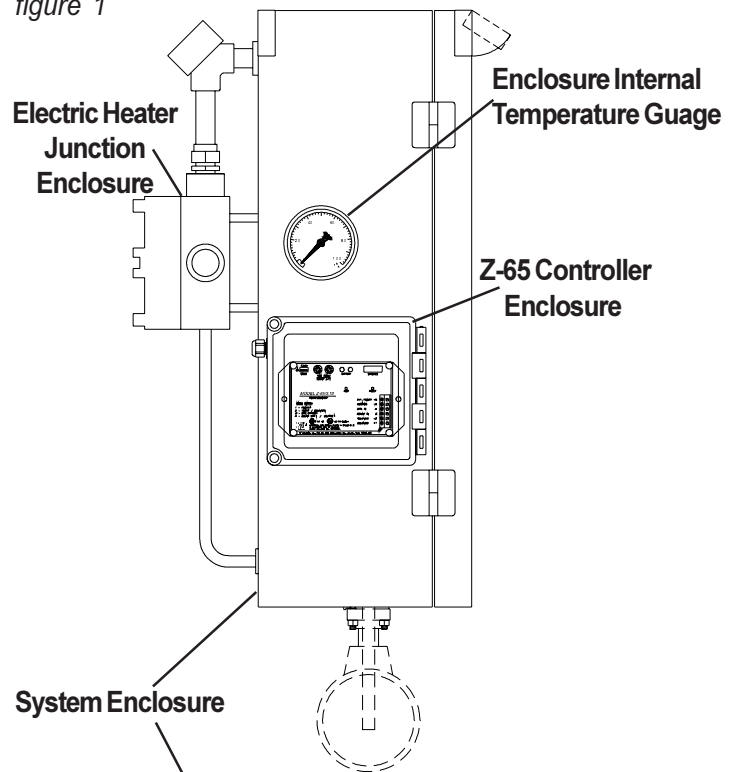
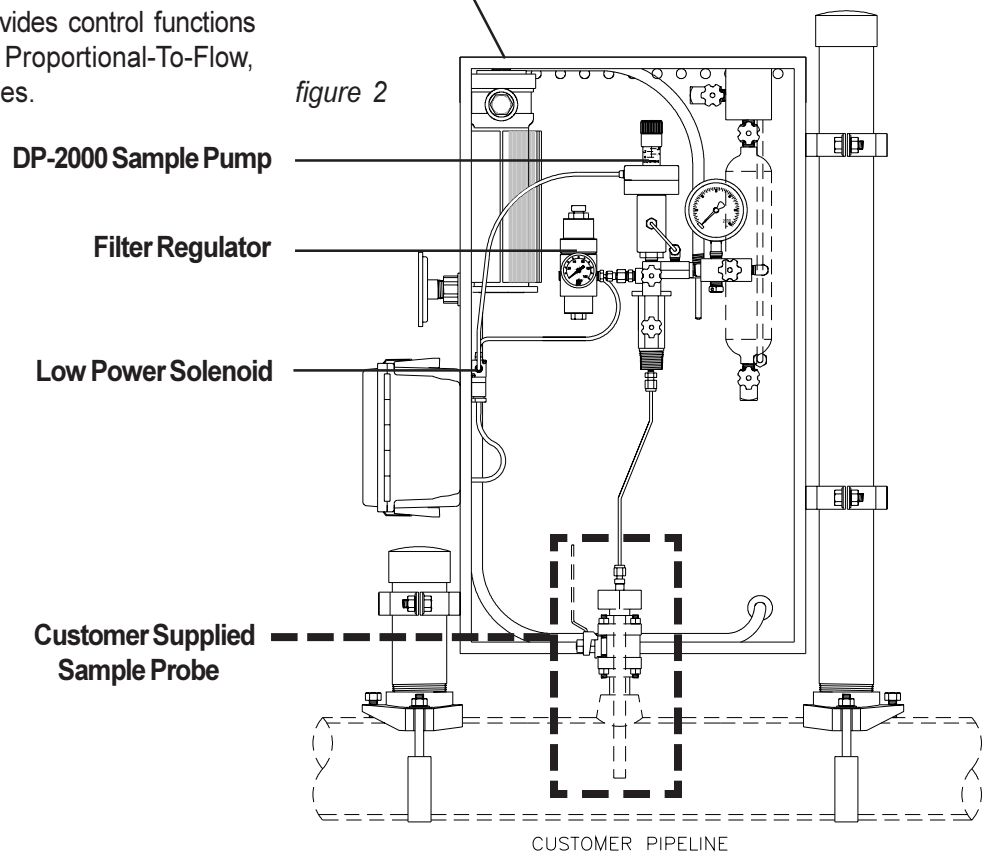

figure 2



SECTION 2: SYSTEM INSTALLATION

System Flow Schematic

figure 2

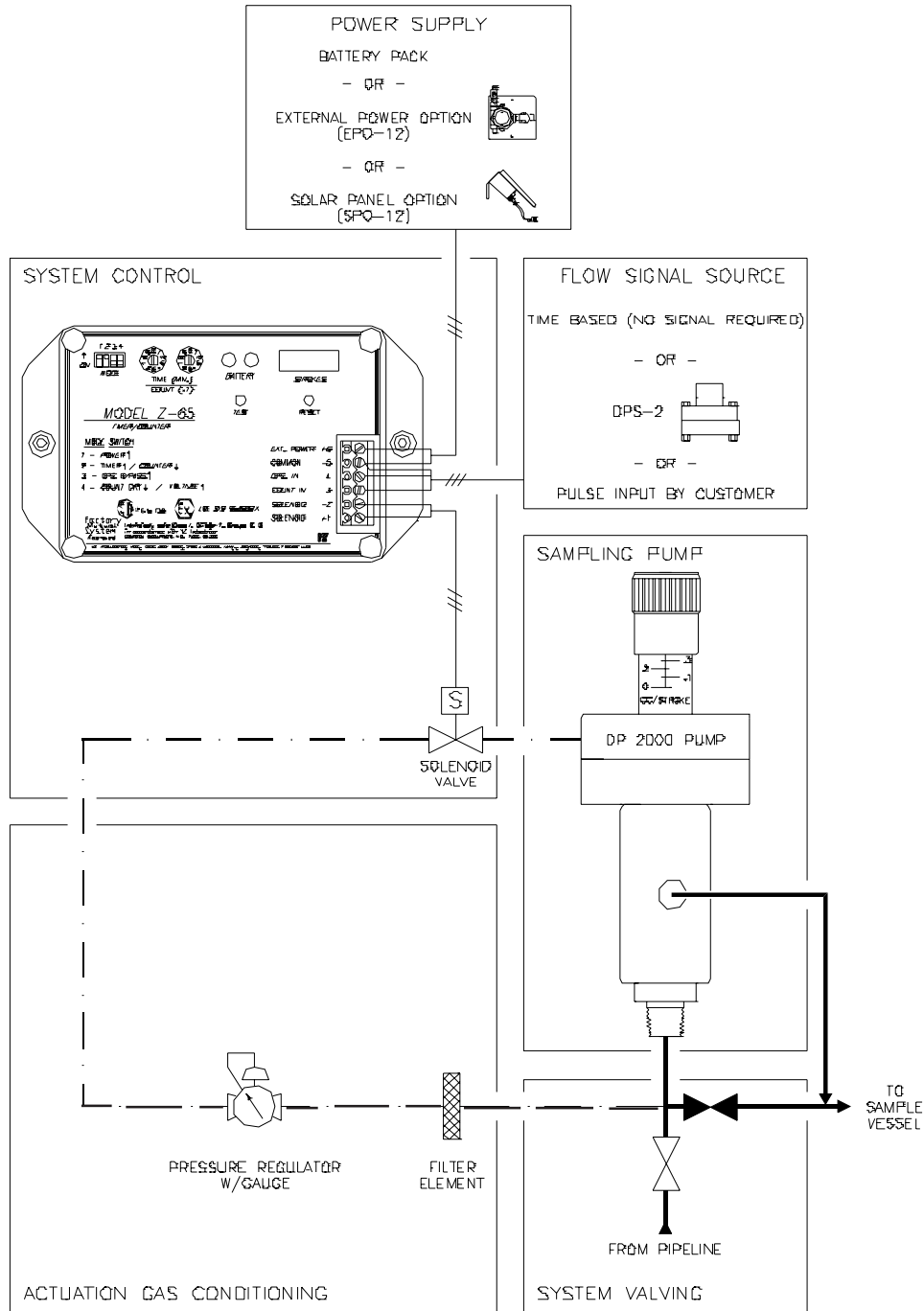

SECTION 2: SYSTEM INSTALLATION

Standard Mounting Location

- 1 The customer supplied sample probe should be a minimum of five pipe diameters from any device which could cause aerosols or significant pressure drops.
- 2 The sample probe should not be located within the defined meter tube region (AGA 3 manual).

figure 3

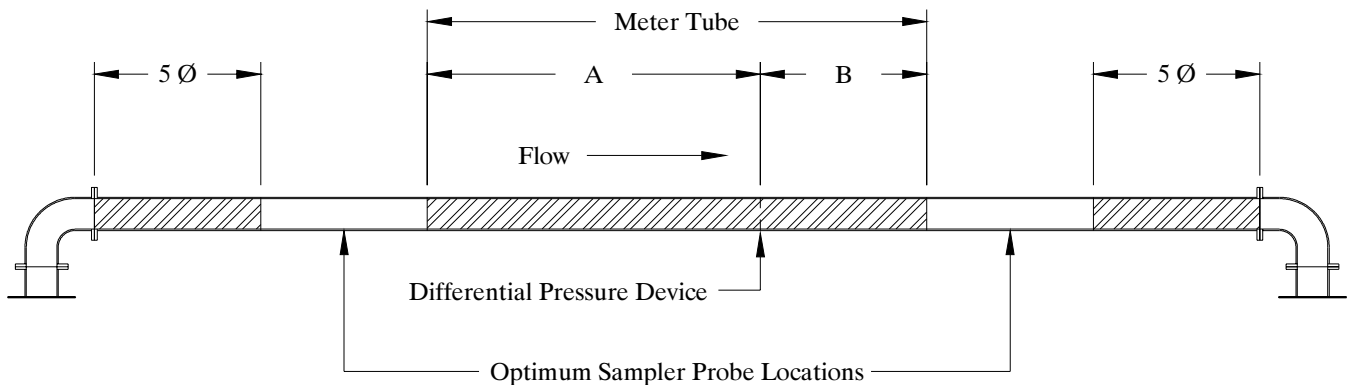

A = The number of unobstructed, straight pipe diameters upstream (see AGA - 3 manual).
B = The number of unobstructed, straight pipe diameters downstream (see AGA - 3 manual).

SECTION 2: SYSTEM INSTALLATION

Standard System Connections

- The DynaPak 2010 sampler should be mounted vertically on a horizontal run of the pipeline.
- The DynaPak 2010 requires a product connection to the pipeline via a customer supplied sample probe, and 1/8" interconnecting stainless steel tubing.
- The end of the sampler probe should penetrate the center 1/3rd of the pipeline.
- The end of the sample probe should be cut parallel to the pipeline.
- Before applying pipeline pressure to the DynaPak 2010, ensure that the isolation valve and purge valve are closed.
- After pipeline pressure has been applied to the sampler, check the probe body/pipeline connection using a liquid leak detector.

CAUTION:

Incorrect operation of valves (over tightening) can result in damage to the valve components (isolation valve bonnet assembly) which might result in the valve stem being screwed out of the probe body. This of course results in product at pipeline pressure being vented continually through this port until this section of the pipeline is shut in. Be aware of the following procedures and information.

· DynaPak valves are of soft seat design and should only be closed or opened with fingers. No wrenches should ever be used.

· If a valve will not seal off with finger tight operation the valve should have maintenance performed to allow proper operation of the valve.

figure 4

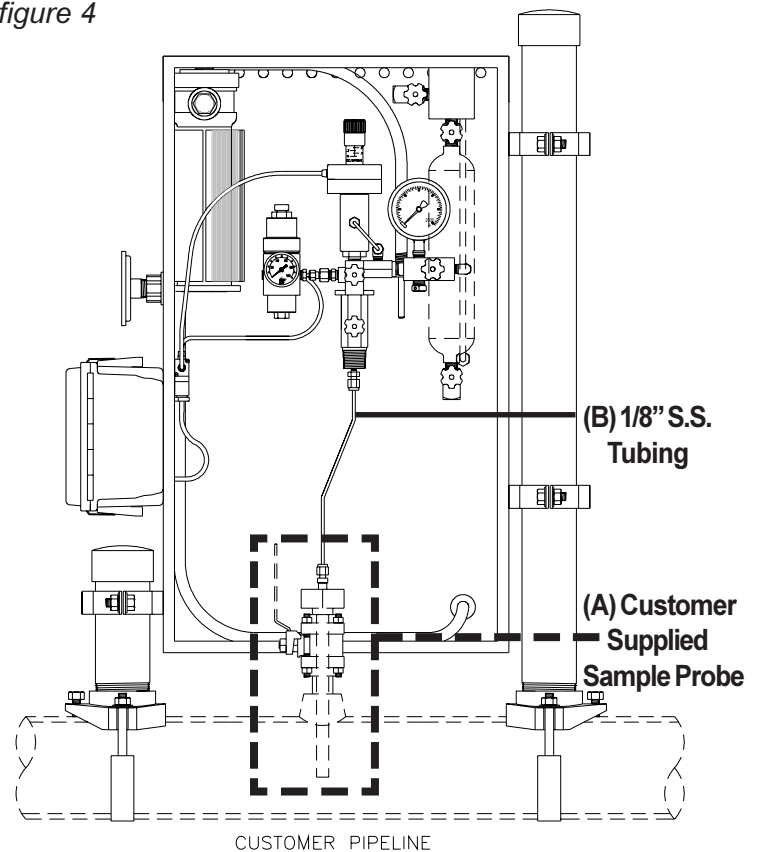
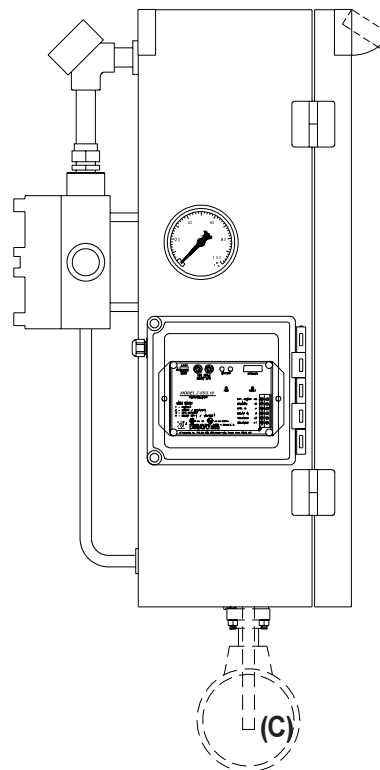

figure 5



SECTION 2: SYSTEM INSTALLATION

Optional DPS-2 Installation:

a. With the low pressure supply valve and the high pressure supply valve closed, connect the DPS-2 *figure 6* to the orifice connection tubing.

b. Open the equalization valve.

c. Open the low pressure supply valve or the high pressure supply valve.

IMPORTANT NOTE:

Do not open either the low pressure supply valve or the high pressure supply valve without ensuring that the equalization valve is open. Failure to do so may damage the DPS-2's internal components.

d. Open the other supply valve.

e. Close the equalization valve.

f. Run the free end of the DPS-2 cable through the cable entry connector located on the upper left side on the DynaPak 2010 enclosure.

g. Connect the DPS-2 cable as shown in the diagram.

h. Tighten the cable entry connector, allowing for enough cable length to open the enclosure.

IMPORTANT NOTE:

For the Z-65 to operate the DP-2010 System, a minimum pressure differential of 3" of water must exist between the high pressure and low pressure ports of the DPS-2.

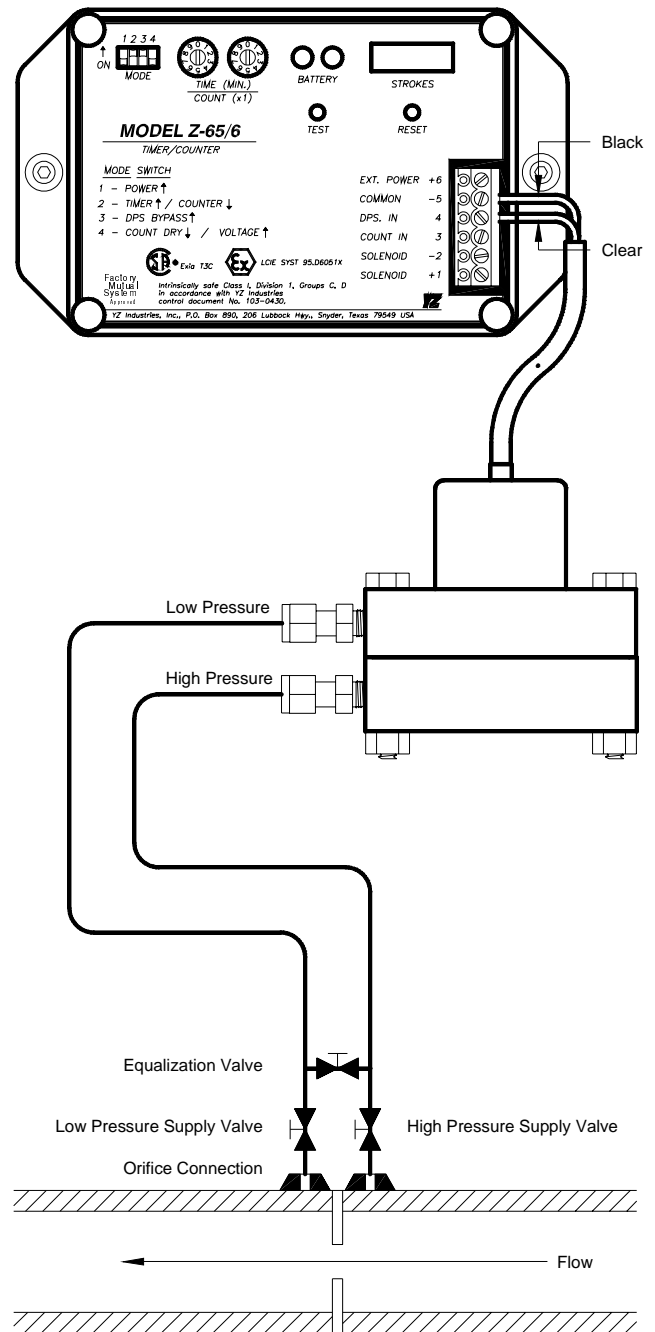

SECTION 3: SAMPLE VESSEL INSTALLATION

Variable Pressure/ Constant Volume Cylinders.

Spun cylinders may be installed in a vertical position on the DynaPak SC vessel manifold. Stainless steel tubing and fittings from the sample discharge port of the sampler are pre-installed to the product end of the sample cylinder, when installed in this manner.

LinkPlus. Install the optional LinkPlus directly into the sample discharge port of the sampler. Use stainless steel tubing and fittings to connect the LinkPlus outlet to the product end of the sample cylinder.

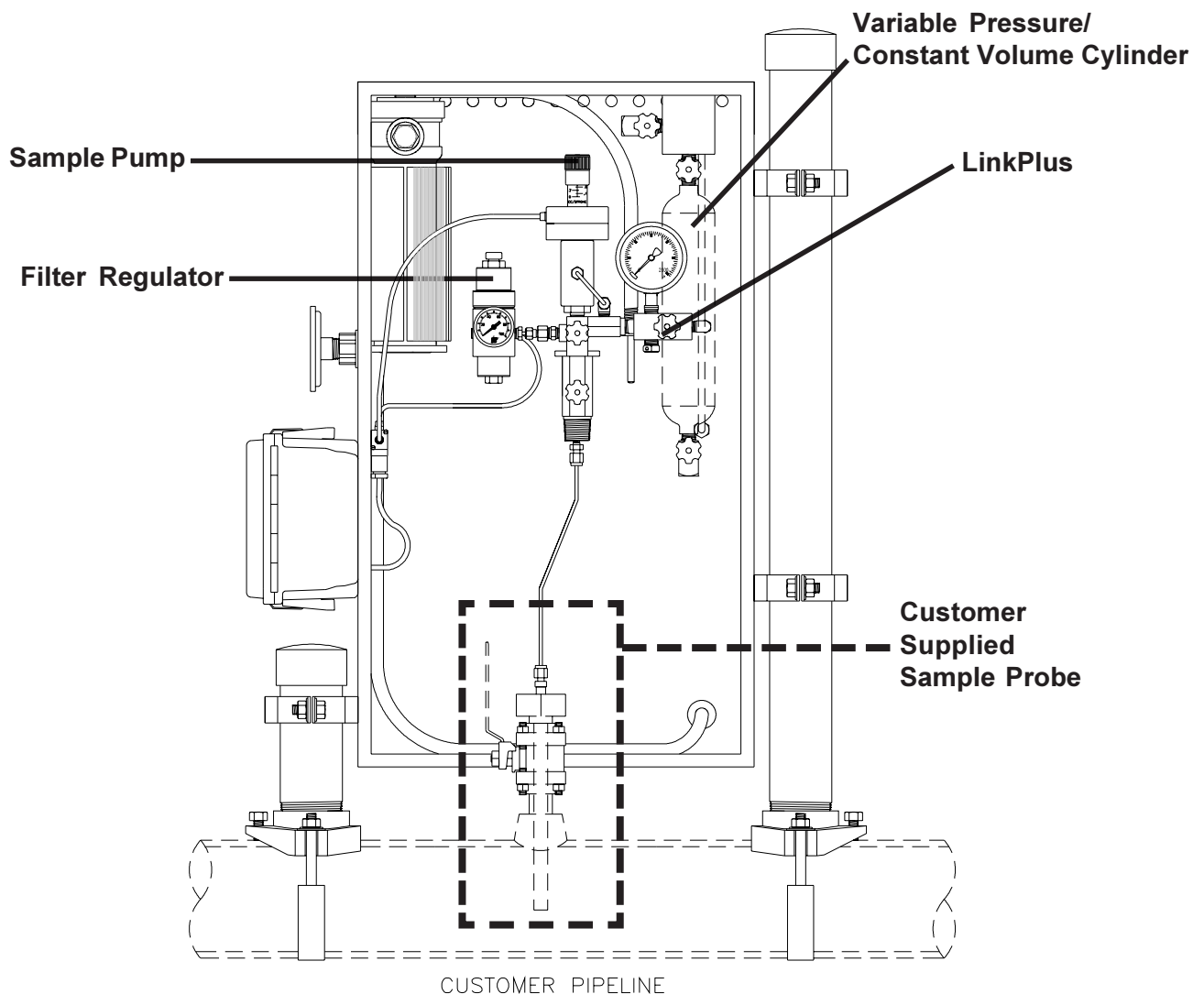

SECTION 4: SYSTEM CONTROL & ELECTRONICS

Overview

The electronic control package provided with your sampling system consists of a solid state Z-65 Controller, and a Low Powered Solenoid. The Z-65 energizes the solenoid which in turn sends a pneumatic actuation signal to the Sample Pump, every time a sample is required either Proportional-To-Flow, or Time.

SAFETY NOTES

- Always use extreme care when performing maintenance on Sampling Systems. Always take necessary measures to assure that electrical classification in the area is considered, before, and during all repairs, and that necessary steps are taken to maintain proper electrical procedures for the classification of the area.

The control package requires you to configure the Z-65 controller to operate in a Proportional-To-Flow mode, [refer Section 5, to page 16](#), a Proportional-To-Time mode, [refer to Section 6, page 19](#), or with the use of an optional DPS-2 switch a Proportional-To-Time w/DPS-2 mode, [refer to Section 7, page 23](#). All wiring connected to the Z-65 controller must be done in accordance with the Wiring Control Document, [refer to Appendix A, page 47](#). DynaPak electronics are rated for use in Class I, Division 1, Groups C and D hazardous locations.

SECTION 5: PROGRAMMING FOR PROPORTIONAL-TO-FLOW OPERATION

Setting Operator Input Values

In this mode of operation, the Z-65 controller is used as a dividing counter to control the rate at which the pump is actuated. The desired time between pump strokes is controlled by the host computer or output device that will give an input pulse to the Z-65 controller.

1 Determine if the incoming input is either a dry contact or voltage pulse.

2. If the input is a dry contact:

a. Terminate the incoming connections to the Z-65 terminal strip (see illustration).

figure 7

b. Turn mode switch 1 to on.

c. Turn mode switch 2 to off.

d. Turn mode switch 3 to on.

e. Turn mode switch 4 to off.

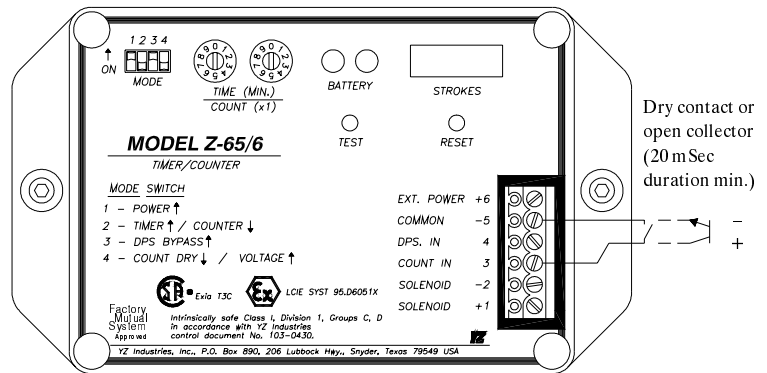
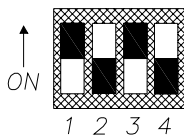

OR

3. If the input is a voltage pulse:

a. Terminate the incoming connections to the Z-65 terminal strip (see illustration).

figure 8

b. Turn mode switch 1 to on.

c. Turn mode switch 2 to off.

d. Turn mode switch 3 to on.

e. Turn mode switch 4 to on.

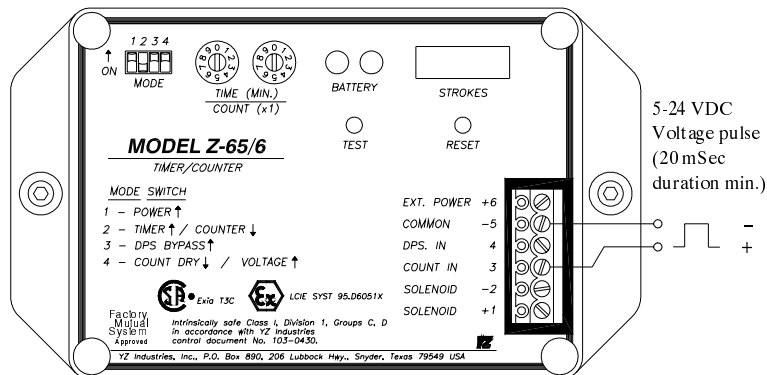
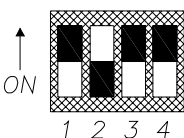

SECTION 5: PROGRAMMING FOR PROPORTIONAL-TO-FLOW OPERATION

4. Calculate the counter setting using the following chart:

1. your pump displacement (from .1 to .4cc's)	=	a. _____
2. your sample cylinder volume in cc's (300cc, 500cc, etc.)	=	b. _____
3. average flow rate (MMCF per day or MCM per day)	=	c. _____
4. sample period in days	=	d. _____
5. pulses/volume metered (pulses/MMCF or pulses/MCM)	=	e. _____
6. counter setting	=	$\frac{a \times c \times d \times e}{(b)}$

		Example #1: English Gas Flow Units	Example #2: Metric Gas Flow Units
pump displacement	(a.) =	.2cc	.2cc
sample cylinder size	(b.) =	300cc	300cc
average flow rate	(c.) =	10 MMCF per day	10MCM/day
sample period	(d.) =	30 days	30 days
pulses per volume metered	(e.) =	100 pulses/MMcf	100 pulses/MCM

Example #1
counter setting = $\frac{.2cc \times 10 \text{ MMcf per day} \times 30 \text{ days} \times 100 \text{ pulses per MMcf}}{300 \text{ cc}}$ = 20 pulses

Example #2
counter setting = $\frac{.2cc \times 10 \text{ MCM per day} \times 30 \text{ days} \times 100 \text{ pulses per MCM}}{300 \text{ cc}}$ = 20 pulses

5. Adjust the pump volume adjustment knob to the value used in the calculation in step 4.

Sample pump displacement per stroke	Number of turns open on the pump volume knob
.1cc	3
.2cc	6
.4cc	12

6. Turn the counter dials to the appropriate number of pulses you want to count before the sample pump strokes.

Example: 20 pulses; turn dials to 20.

Press the test button once to load the value into the memory.

IMPORTANT NOTE:

If the calculated counter setting is less than 1 or greater than 99, the pulses per volume metered will need to be adjusted. This can be programmed in most flow meters to the desired rate. If the calculated counter setting is less than 1, increase the pulses per volume metered. If the calculated counter setting is greater than 99, decrease the pulses per volume metered.

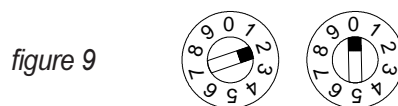

COUNT (x1)

SECTION 6: PROGRAMMING FOR PROPORTIONAL-TO-TIME OPERATION

1. Calculate the sampling rate using the following 30 day chart:

figure 10

Number of turns open on pump stroke knob	sample pump displacement per stroke	Sample cylinder volumes			Sample rate (minutes)
		1000 cc	500 cc	300 cc	
3	.100	4	9	15	
6	.200	9	18	30	
9	.300	13	27	45	
12	.400	18	36	60	

2. Set the timer dials on the Z-65 to the sample rate from step 1.

Example

figure 11

18 minutes

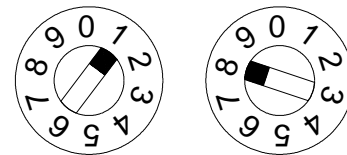

TIME (MIN.)

COUNT (x1)

IMPORTANT NOTE:

To obtain maximum battery life, choose the longest time interval and the largest pump displacement setting possible.

IMPORTANT NOTE:

The time (18 minutes) above corresponds to the dial setting shown for the Z65 model with the timer range setting in the factory position (jumper on the two left pins). See section 11 [Timer Range Setting](#).

SECTION 6: PROGRAMMING FOR PROPORTIONAL-TO-TIME OPERATION

- Adjust the pump volume adjustment knob to the value used in the calculations in step 1.

Sample pump displacement per stroke	Number of turns open on the pump volume knob
.1cc	3
.2cc	6
.4cc	12

figure 12

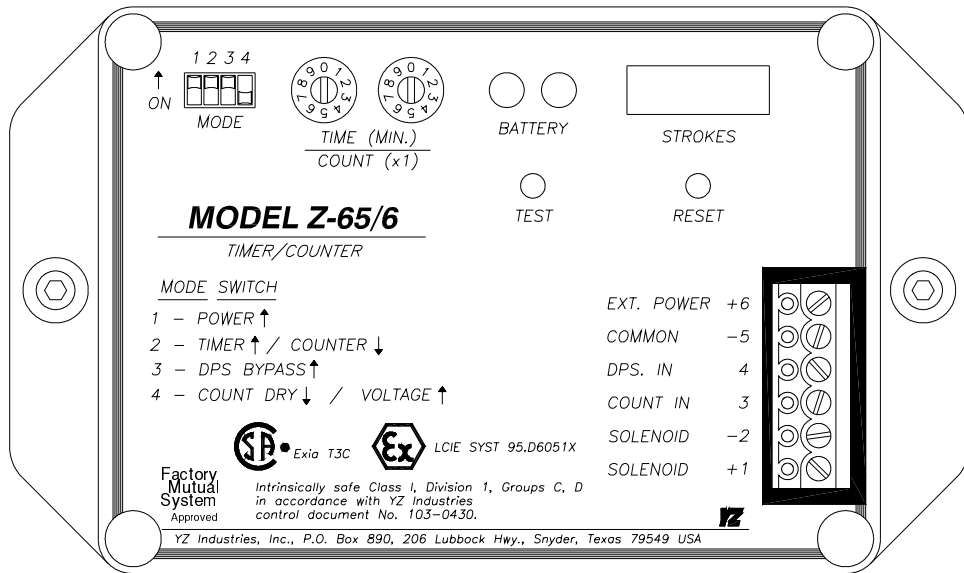

- Turn mode switch 1 to on.
- Turn mode switch 2 to on.
- Turn mode switch 3 to on.
- Turn mode switch 4 to off.
- Press the test button once to initiate the timer sequence.

figure 13

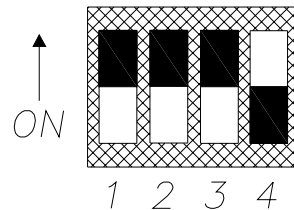

SECTION 7: PROGRAMMING FOR PROPORTIONAL-TO-TIME W/DPS-2

1. Calculate the sampling rate using the following 30 day chart:

figure 14

Number of turns open on pump stroke knob	sample pump displacement per stroke	Sample cylinder volumes			Sample rate (minutes)
		1000 cc	500 cc	300 cc	
3	.100	4	9	15	
6	.200	9	18	30	
9	.300	13	27	45	
12	.400	18	36	60	

2. Set the timer dials on the Z-65 to the determined time from step 9.1.

Example

figure 15

18 minutes

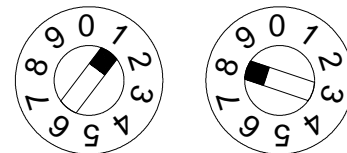

TIME (MIN.)

COUNT (x1)

IMPORTANT NOTE:

To obtain maximum battery life, choose the longest time interval and the largest pump displacement setting possible.

IMPORTANT NOTE:

The time (18 minutes) above corresponds to the dial setting shown for the Z65 model with the timer range setting in the factory position (jumper on the two left pins). See section [Timer Range Setting](#).

SECTION 7: PROGRAMMING FOR PROPORTIONAL-TO-TIME W/DPS-2

- Adjust the pump volume adjustment knob to the value used in the calculations in step 1.

Sample pump displacement per stroke	Number of turns open on the pump volume knob
.1cc	3
.2cc	6
.4cc	12

figure 16

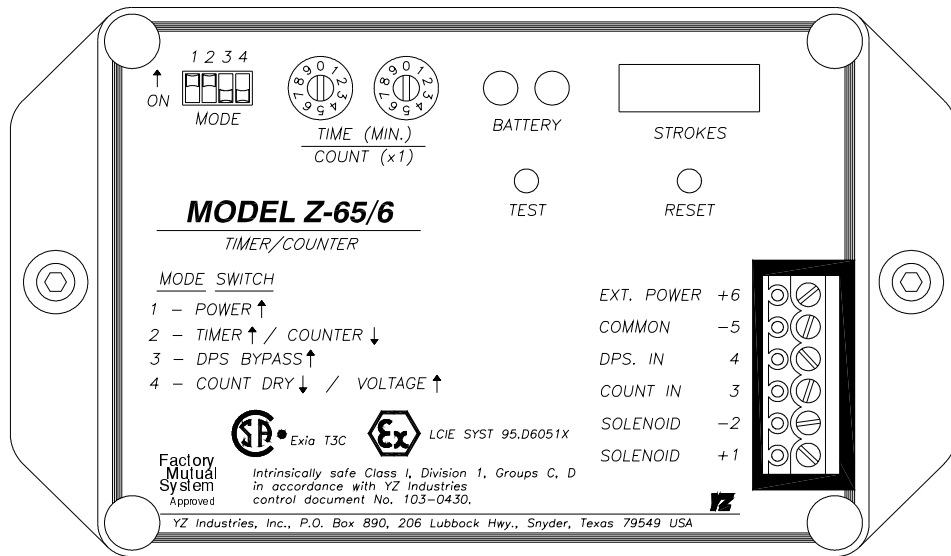

- Turn mode switch 1 to on.
- Turn mode switch 2 to on.
- Turn mode switch 3 to off.
- Turn mode switch 4 to off.
- Press the test button once to initiate the timer sequence.

figure 17

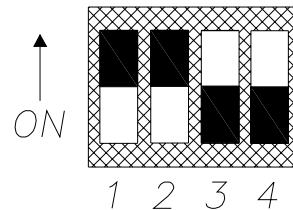

IMPORTANT NOTE:

For the Z-65 to operate the DP-2010 System, a minimum pressure differential of 3" of water must exist between the high pressure and low pressure ports of the DPS-2.

SECTION 8: MECHANICAL SYSTEM

Overview

The DynaPak mechanical system, *figure 18* are composed of the sample pump, and filter regulator. These components of the system are shown here and described in the following pages.

figure 18

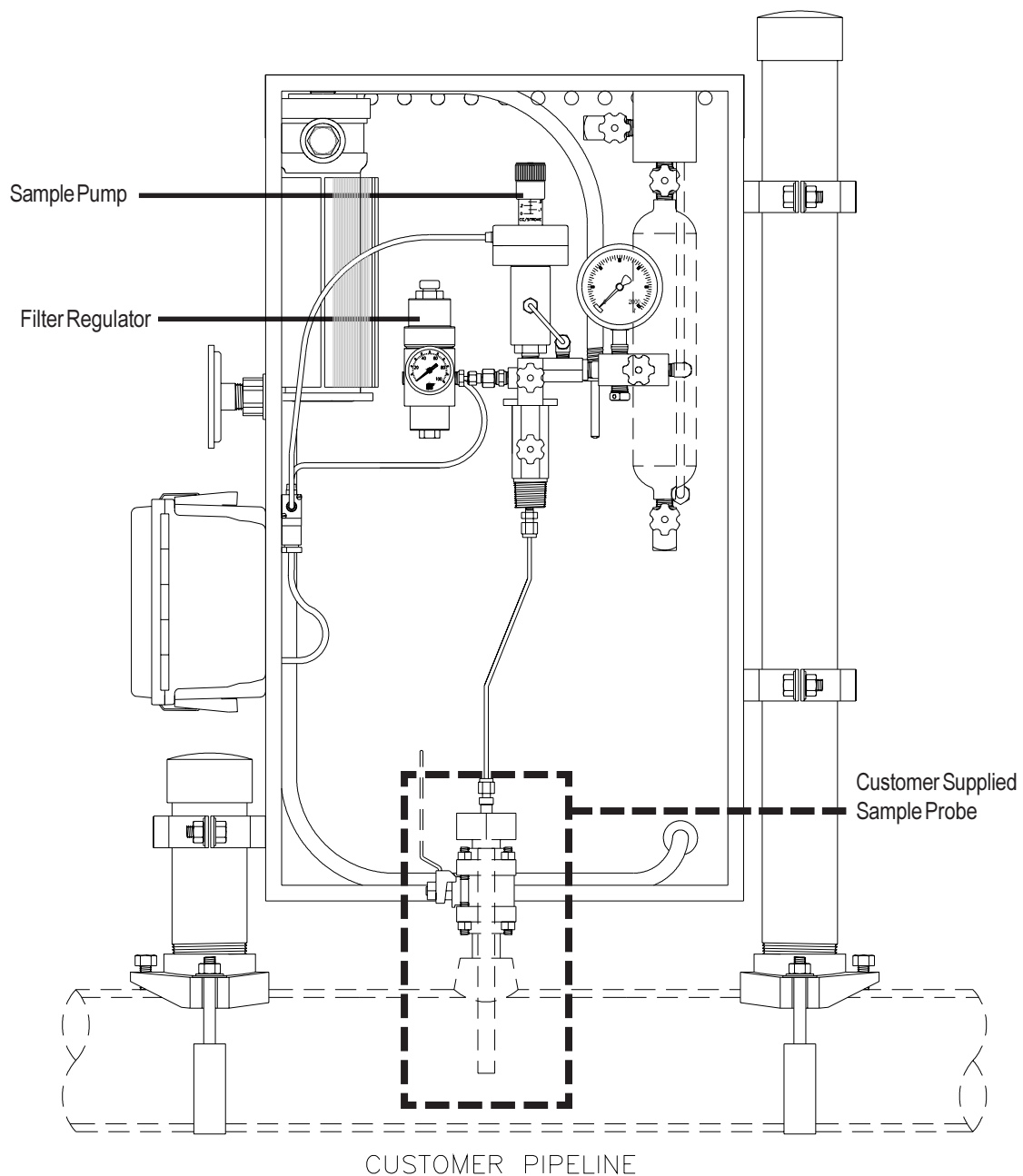

SECTION 8: MECHANICAL SYSTEM

DP-2000 Sample Pump

The DP-2000 Sample Pump, [refer to Appendix A, page 49](#), is a positive displacement plunger pump. It's dependable design provides for dependable sampling service, while also providing a very simple to maintain pump, with very few internal components. The pump has an adjustable displacement of .1 to .4 cc per stroke. The set displacement may be viewed at the volume adjustment knob, [refer to Appendix A, page 50](#), located on the top of the DP-2000 pump. Adjustment is simple. Turn the volume adjustment knob clockwise to increase the pump volume displacement per stroke, or turn the volume adjustment knob counter clockwise to decrease the pump volume displacement per stroke. Final control of the volume of sample to be gathered during the sample cycle period, is achieved by the Z-65 controller.

This pump has internal pressure balancing capabilities that allows the pump to function properly when the pipeline pressure is greater than the sample vessel pressure, or when the sample vessel pressure is greater than the pipeline pressure.

Each time the pump strokes product previously captured in the pump chamber is forced toward the sample cylinder. As the pump plunger return to a resting state a new fresh sample is captured in the pump. Once the pump completes its stroke, the cycle is ready to begin again.

SECTION 8: MECHANICAL SYSTEM

Filter Regulator

The DynaPak Filter Regulator, [refer to Appendix A, page 51](#), is a stainless steel filtered regulator to supply the supply gas required to actuate the sample pump. It is capable of providing actuation pressure from pipeline pressures to required actuation pressures in a single dependable step.

Maintenance is minimal, but is certainly dependant on gas quality. Should the gas supplied to the filter regulator require significant filtration, replacement of the filter may be more frequent than normal, [refer to System Maintenance, page 35](#).

SECTION 9: SYSTEM OPERATION

Preparing The System for Operation

- When all of the tubing connections have been completed, close the purge valve on the front of the sampler probe body. Open the sample probe supply valve to allow pipeline pressure into the sampler, refer to Section 8, page 27. Check all connections using a liquid leak detector.
- Adjust the filter/regulator from the following ranges, refer to Section 8, page 29:

Pipeline Pressure	Actuation Pressure
Under 700 psig (48 Bar)	50 psig (3.5 Bar)
Over 700 psig (48 Bar)	65 psig (4.5 Bar)

figure 19

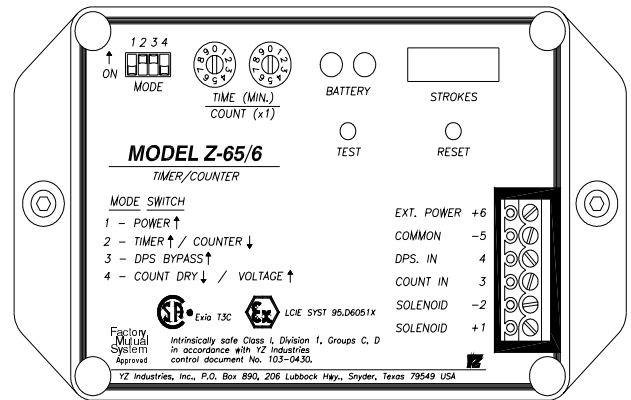

- Turn the stroke adjustment knob on the top of the pump counterclockwise to set the pump displacement at .4 cc/stroke, refer to Section 8, page 28.
- Move all of the mode switches on the Z-65 to their off positions, figure 20.
- Move both timer/counter dials to the 0 position (00 minutes), figure 21.
- Move mode switches 1, 2 and 3 to the on position. The pump will begin stroking once every 2 seconds in a diagnostic test mode, figure 22.
- Allow the sampler to operate until the pipeline pressure **plus** 100 psi (6.9 Bar) is achieved at the sample discharge.
- Return the mode switches to their off positions, figure 23.
- Check all connections from the sampler discharge to the connection on the sample cylinder using a liquid leak detector.
- If no leaks are found, the pump and tubing should be considered tested and functional.

figure 20

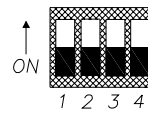

figure 21

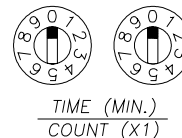

figure 22

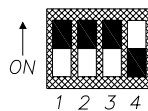
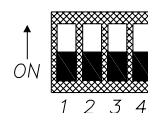

figure 23



NOTE: Black indicates the switch position.

SECTION 9: SYSTEM OPERATION

Preparing The System for Operation (Electric Heater)

11. Remove the explosion proof enclosure cover from the heater thermostat housing located on the outside rear of your sampler.

IMPORTANT NOTE:

Always use extreme care when performing maintenance on or when making electrical connections to your sampling system. Always take the necessary measures to assure that electrical classifications in the area are considered, before, and during all repairs, or installations, and that necessary steps are taken to maintain proper electrical procedures for the classification of that area.

12. Connect the conduit, pack-off, etc to the right side of the thermostat enclosure .
13. Connect the white lead of the incoming 120 VAC power supply wiring to the loose white lead inside the thermostat enclosure.
14. Connect the black lead of the incoming 120 VAC power supply wiring to the right terminal on the thermostat. It should have no other wires connected to it.
15. Connect the green (ground) lead of the incoming 120 VAC power supply wiring to the ground connection terminal screw located inside of the thermostat enclosure.
16. Adjust the thermostat to the desired temperature.
17. Periodically monitor the temperature indicated on the outside temperature gauge while the sample is closed and operation to assure that your desired temperature is being maintained. Occasional thermostat adjustment may be required to find a setting that is acceptable for varying ambient conditions.

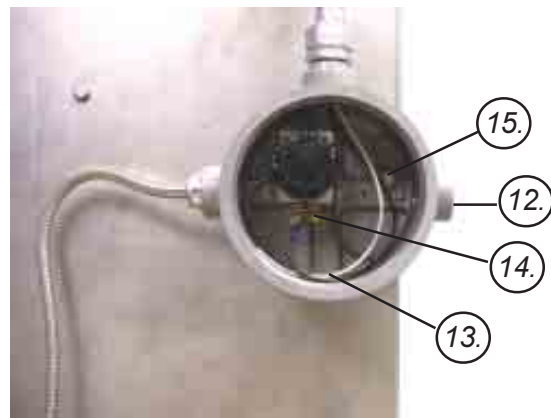

SECTION 10: SYSTEM MAINTENANCE

Preventative Maintenance Schedule

A preventative maintenance program serves to anticipate maintenance issues prior to waiting until the system requires service. Like changing the oil & filters in an automobile, by choosing to service the various parts and operation in the Sampling System at regular intervals, the technician can perform the maintenance service when desired, rather than when required, such as in the middle of night.

The key is to perform maintenance before it is required. The preventative maintenance schedule implemented should consider the application of the sampler. Many of these considerations include: the weather environment; the condition of, the actuation gas, the product condition and quality, and the pump stroke frequency. All of these issues must be considered when establishing a preventative maintenance schedule.

Recommended Maintenance Schedule

Monthly Inspection

1. Verify system pressures
2. Check for leaks
3. Test the battery.
4. Test the system for leaks each time a fitting or connection has been made.

Semi-Annual Inspection

1. Clean and lubricate the sample pump
2. Check the filter element, and replacing as necessary.

Annual Inspection

1. Rebuild pump
2. Test the Sampler System performance and service, as needed
3. Replace Z-65 Battery Assembly.

Recommended Spare Parts List

Part #	Description	Recommended Quantity
D3-0002	DP-2000 pump seal replacement kit	1
D3-0003	Filter Regulator repair kit	1
A4-0001	Solenoid	1
E3-2001	Z-65 Battery Assembly	1

SECTION 10 : SYSTEM MAINTENANCE

figure 24

Cleaning and lubricating the DP-2000 pump:

1. Close the isolation valve.
2. Disconnect the plastic tubing from the solenoid valve to the pump diaphragm housing by depressing the tubing release sleeve on the diaphragm housing fitting while pulling out the tubing. It is not necessary to remove the fitting from the diaphragm housing.
3. Remove the sample discharge (1/8" stainless steel tubing) from the pump body.
4. Screw the stroke adjustment knob all the way down to the 0 cc/stroke setting.
5. *Unscrew the pump body by hand from the inlet check valve assembly. Separation at this point is recommended to maintain proper tubing location and alignment between the pump body and the probe body. Do not remove the inlet check valve body from the manifold unless cleaning is necessary. To replace the inlet check valve o-ring, carefully cut the o-ring off the head of the dart and stretch the new o-ring over the head of the dart using a light coat of assembly grease.
6. Remove the diaphragm housing from the pump body by unscrewing the diaphragm housing and carefully pulling the plunger out of the pump body. Inspect the plunger shaft for damage or wear. The diaphragm chamber houses the diaphragm, return spring, stroke adjustment screw and plunger assembly. The diaphragm chamber should not be disassembled unless one of these items needs replacing.

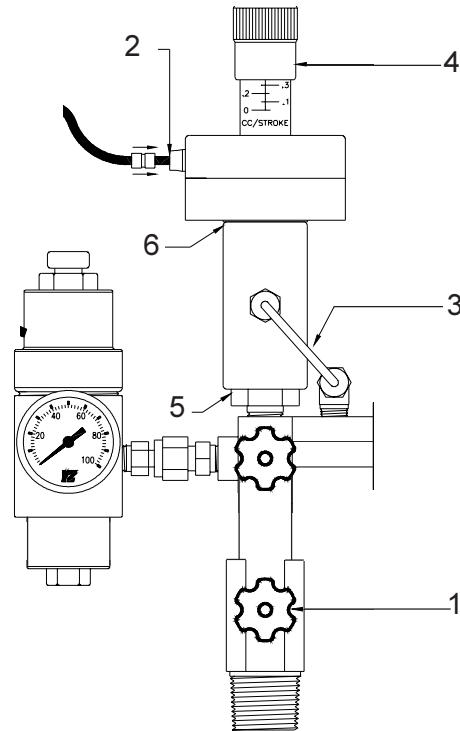

**Screw the stroke adjustment screw all the way down.*

SECTION 10: SYSTEM MAINTENANCE

- Remove the internal bushings and o-rings from the pump body by inserting a non-metallic rod (larger than 1/4", smaller than 1/2") into the top of the pump body. Gently tap to remove all bushings and o-rings out the bottom of the pump body, figure 25.

figure 25

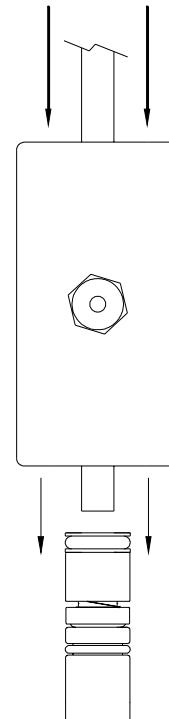

- Clean and inspect all components. Replace if necessary.

IMPORTANT NOTE:

Normal service generally requires only the replacement of the o-rings and seal. A seal repair kit (part number D3-0002) is available from YZ.

- Apply a light coat of non-soluble assembly grease on all o-rings, bushings, and the plunger shaft to prevent damage.
- Install the body bushing into the bottom of the pump body, figure 26.
- Insert all other bushings, springs, and o-rings in their respective sequence on the plunger shaft, figure 26.
- Carefully install assembly into the top of the pump body, and screw the actuator assembly onto the pump body. (Tighten firmly by Hand ONLY)
- Install the pump assembly on the inlet valve assembly. (Tighten firmly by Hand ONLY).
- Connect the 1/8" stainless steel tubing to the pump body and 1/8" plastic tubing to the diaphragm housing.
- Open the isolation valve.
- Adjust the stroke adjustment knob to its original setting.
- Pressure test the pump as previously described for proper operation.

figure 26

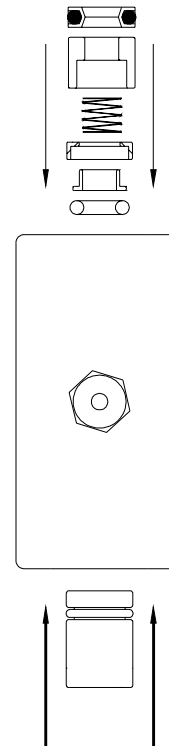

SECTION 10 : SYSTEM MAINTENANCE

Replacing a Depleted Battery:

1. Remove the four thumb screws, cover plate and orange terminal connector.
2. The battery is located in the lower left hand corner of the Z-65 controller assembly.
3. Unclip the battery plug from the battery receptacle.
4. Replace the depleted battery with a fresh battery pack (part No. E3-2001). Refer to *figure 27* to assure proper battery wire placement in the Z-65 enclosure.
5. Return the mode switches to their original positions.

figure 27

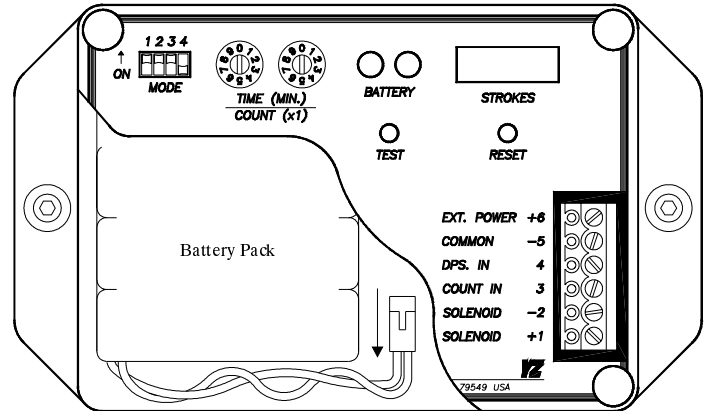

SECTION 11: SYSTEM TROUBLESHOOTING

How to Use This Section

The recommendations contained in this section should be used as a preliminary information resource to remedy operational issues with the DynaPak Sampling System. It is important to read all of the definitions and notes prior to initiating work.

Each subsection contains a description of the indicators followed by a step-by-step trouble shooting procedure.

For Additional Help

Any issue that can not be resolved through the use of this reference, please contact YZ Technical Service at:

T: 1.800.653.9435
T: 1.936.788.5526, International Calls
F: 1.936.788.5720
Em: Service@yzhq.com

Step-by-Step Resolution

Using a step-by-step method to resolve issues on the Sampling System will reduce maintenance time and assist in returning the system to service quicker.

The following represent the recommended chronology to resolve issues:

Resolve issues to the following order:

- a. *Battery Power*, [page 42](#)
- b. *Z-65 Controller*, [page 43](#)

SAFETY NOTES

- Always use extreme care when performing maintenance on Sampling Systems. Always take necessary measures to assure that electrical classification in the area is considered, before, and during all repairs, and that necessary steps are taken to maintain proper electrical procedures for the classification of the area.
 - Take special care when disconnecting any fitting, to assure that product and/or pressure will not be released when the connection is broken. This system may contain liquid and/or gas at high pressures.
-

SECTION 11: SYSTEM TROUBLESHOOTING

BatteryPower

The Z-65 controller, and the low powered solenoid are normally powered by the Z-65 Battery Assembly. The battery assembly is not a rechjargable type battery. Under normal sampling conditions this battery may last 2 years. A built in warning LED is provided to advise the operator when the Battery needs changing.

Battery Power Troubleshooting Steps

1. Set the mode switches as follows, figure 28:

Position 1, 2 and 3 on

2. Set the time switches to the 01 position, figure 29. This will set the solenoid output rate to one actuation every one minute (based on the factory set time range for the Z-65 model, refer to figure 45, page46).

3. Depress the test switch to test the battery. A green LED will illuminate if the battery is good and a red LED will illuminate if the battery is low, figure 30.

IMPORTANT NOTE:

*The solenoid must be connected to test the battery condition. **Battery condition cannot be tested with a volt meter.***

figure 28

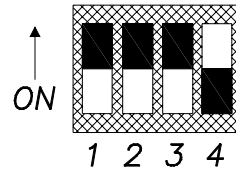
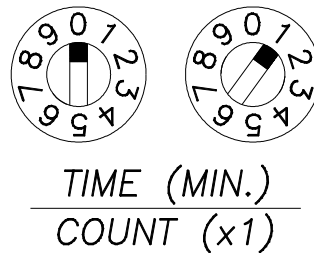

figure 29



IMPORTANT NOTE:

*Time switches must **not** be in 00 position to test the battery.*

figure 30

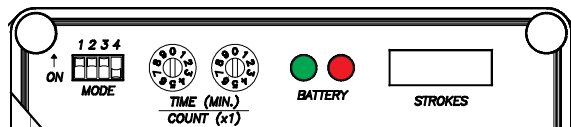

SECTION 11: SYSTEM TROUBLESHOOTING

Z-65 Counter Mode

If the Z-65 controller is to be operated in the counter mode, an input pulse from some other flow monitoring device must be received by the Z-65. These pulses are then totalized, and the low powered solenoid is energized when a sample is needed.

Z-65 Counter Mode Troubleshooting Steps

1. Set the mode switches as follows, refer to, figure 31:

Position 1 and 3 on, 2 and 4 off.

2. Set the count switches to 00 to enter the diagnostic mode, refer to figure 32. This mode enables the user to determine if the proper input pulses are being received at the count input (ter. #3).

- A. Dry Contact Input:** mode switch 4 should be in the off position, refer to figure 34. Depress the test switch and hold. A red LED should illuminate. When the dry contact input is received at the counter input (ter. #3) the green LED will turn on and off and the red LED will illuminate again. This will normally occur very quickly and give the appearance that the green LED blinks on when the pulse input is received and removed, figure 33.

figure 31

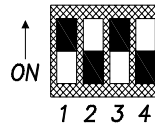

figure 32

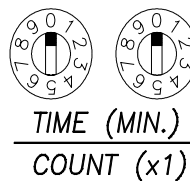

figure 34

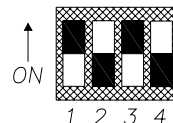
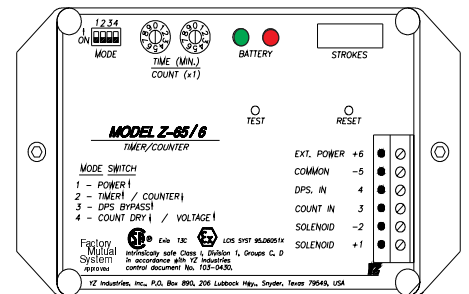

figure 33



dry contact
open collector
(20 mSec duration min.)



SECTION 11: SYSTEM TROUBLESHOOTING

B. Voltage Pulse Input: move mode switch 4 to the on position, refer to figure 35. **Depress** the test switch and **hold**. A green LED should illuminate. When the voltage pulse input is received at the count input (ter. #3) the red LED will turn on and off and the green LED will illuminate again. This will normally occur very quickly and give the appearance that the red LED blinks on when the pulse input is received and removed, figure 36.

figure 35

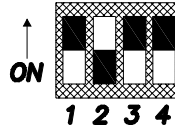
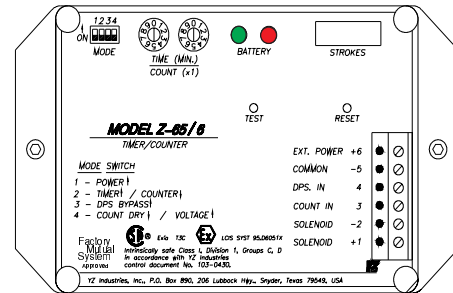

figure 36



Z-65 Timer Mode

If the Z-65 controller is to be operated in the timer mode, it acts as a simple recycling timer. Set up is detailed in [Section 6, page 19](#). If a sample is not taken when expected in this mode the following should assist in restoring the sampler to proper operation.

SECTION 11: SYSTEM TROUBLESHOOTING

Z-65 Timer Mode Troubleshooting Steps

Mechanical Operation Test:

1. Set the mode switches as follows, figure 37:
Positions 1, 2 and 3 on.
Position 4 off.

figure 37

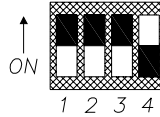

2. Set the time switches to 00 to enter the diagnostic mode, figure 33. This mode enables the user to increase the solenoid output rate to one pulse every two seconds.

figure 38

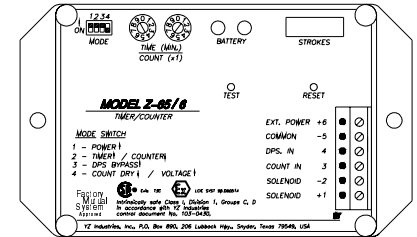
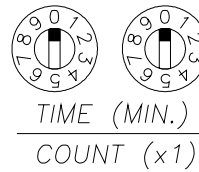

Mechanical Operation Test

DPS-2 Test

1. Set the mode switches as follows, figure 39:
Position 1 and 2 on.
Position 3 and 4 off.

figure 39

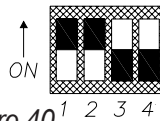

2. Set the time dials to 00 to enter the diagnostic mode, figure 40.
3. This mode enables the operator to determine if the DPS is operating properly. This is accomplished by **depressing and holding** the test switch. If the DPS is sensing flow in the pipeline, the green LED should illuminate. If flow is not present, the red LED should illuminate, figure 41.

figure 40

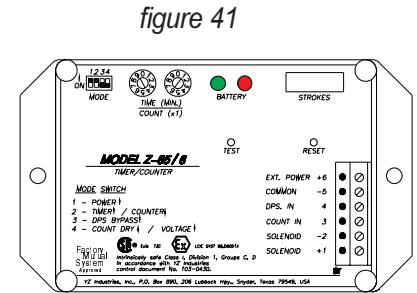
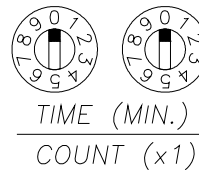

figure 41

DPS-2 Test

LCD Stroke Indicator Test Mode:

1. To test the stroke counter, set the mode switches as follows, refer to figure 42:
Positions 1, 2 and 3 on.
Position 4 off.
2. Set the time switches to 00, figure 43.

figure 42

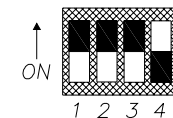
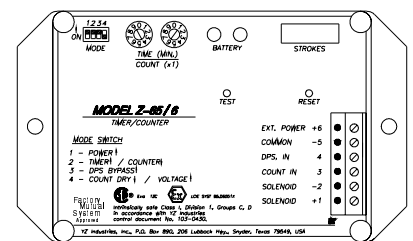
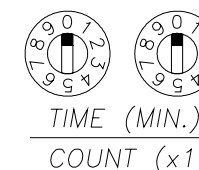

figure 43



SECTION 11: SYSTEM TROUBLESHOOTING

3. **Unscrew** the thumbscrews and **remove** the six position terminal strip and cover. This will expose the battery pack and the three position configuration jumper (located in the lower right corner of the Z-65 controller assembly).
4. **Set** the configuration jumper to the far right position marked stroke indicator test, figure 44.
5. This will cause all six digits to become active on the stroke counter. **Depress** the reset. The stroke counter should increment 000000, 111111, etc., up to 999999 each time the solenoid fires. When the counter display reads 999999, the test is complete.

figure 44

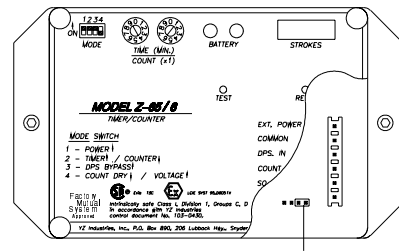

12.3 d - Jumper switch location

IMPORTANT NOTE:

When the test is complete, move the jumper back to the factory position (far left position).

Timer Range Setting

There are two Z-65 models: the Z-65/6.1 and Z-65/6.03. Each Z-65 timer has two ranges for the timer setting dials.

1. Z-65/6.1 Range Setting:
xx minutes: **set** the configuration jumper to the far left position (factory setting), figure 45.
- x.x minutes: **set** the configuration jumper to the center position, figure 46.

figure 45

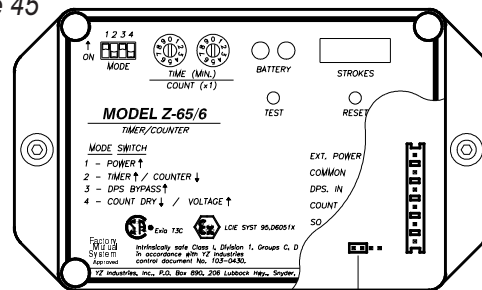

Jumper switch location for 1 -99 counts (xx) factory positioned

figure 46

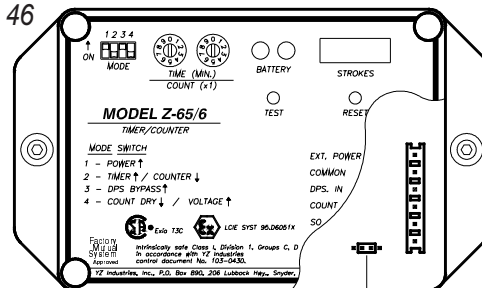

Jumper switch location for .1 -9.9 counts (x.x)

IMPORTANT NOTE:

To obtain maximum battery life, choose the longest solenoid stroke rate possible.

SECTION 11: SYSTEM TROUBLESHOOTING

2. Z-65/6.03 Range Setting:
 x.x minutes: **set** the configuration
 jumper to the far left position
 (factory setting), figure 47.

figure 47

.xx minutes: **set** the configuration
 jumper to the center position,
 figure 48.

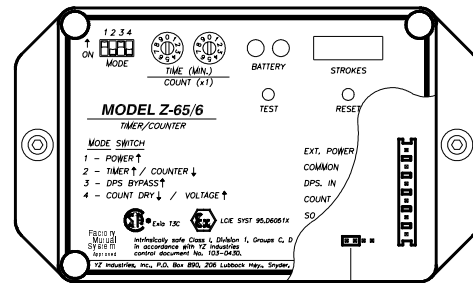

Jumper switch location
 for .1 - .99 counts (x.x)
 factory positioned

IMPORTANT NOTE:

To obtain maximum battery life, choose the longest
 solenoid stroke rate possible.

figure 48

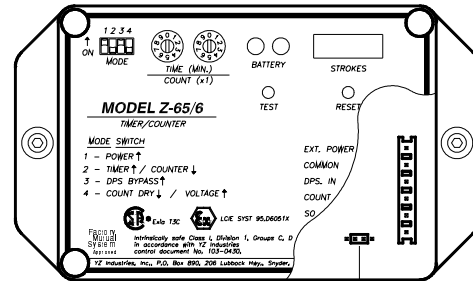

Jumper switch location
 for .03 - .99 counts (.xx)

APPENDIX A: ILLUSTRATIONS

DynaPak 2000 Pump, Assembled

Figure 49

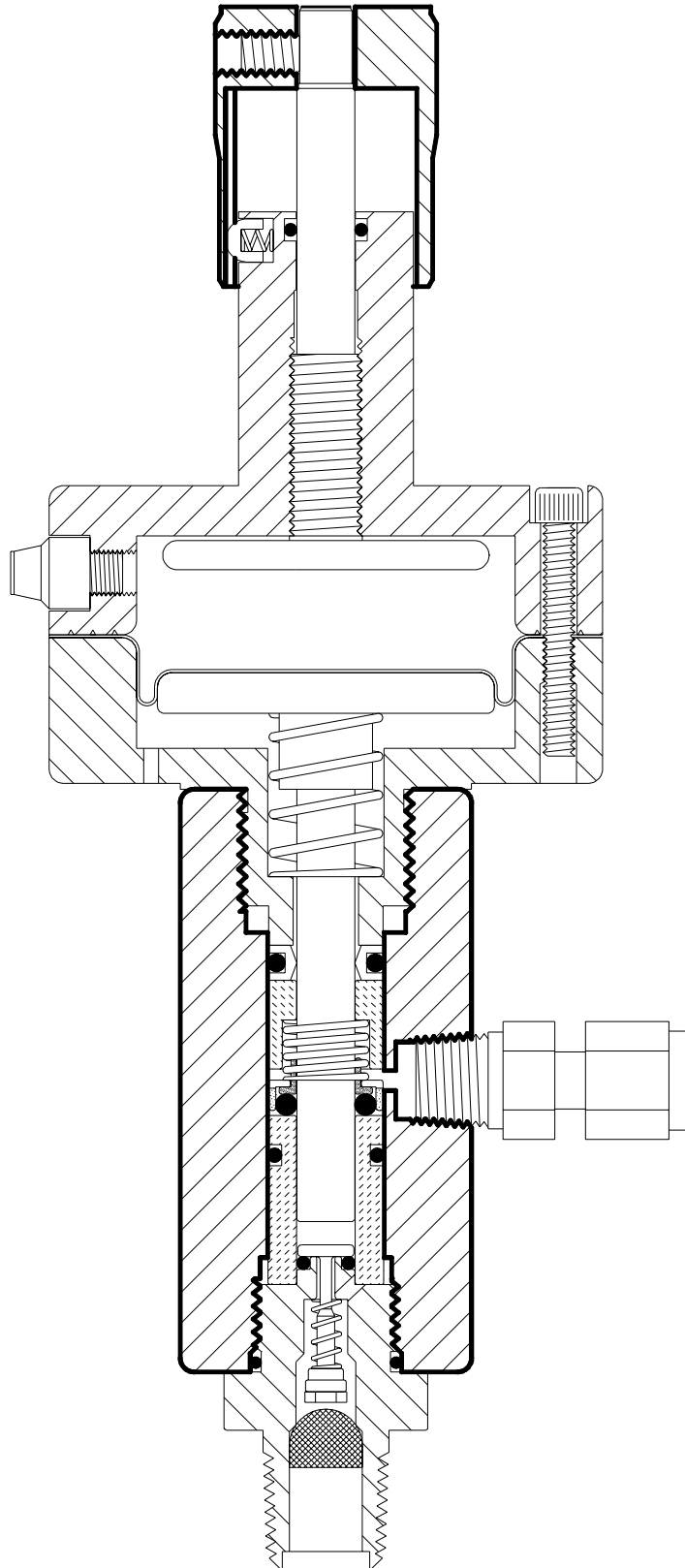

APPENDIX A: ILLUSTRATIONS

DynaPak 2000 Pump, Exploded View

Figure 50

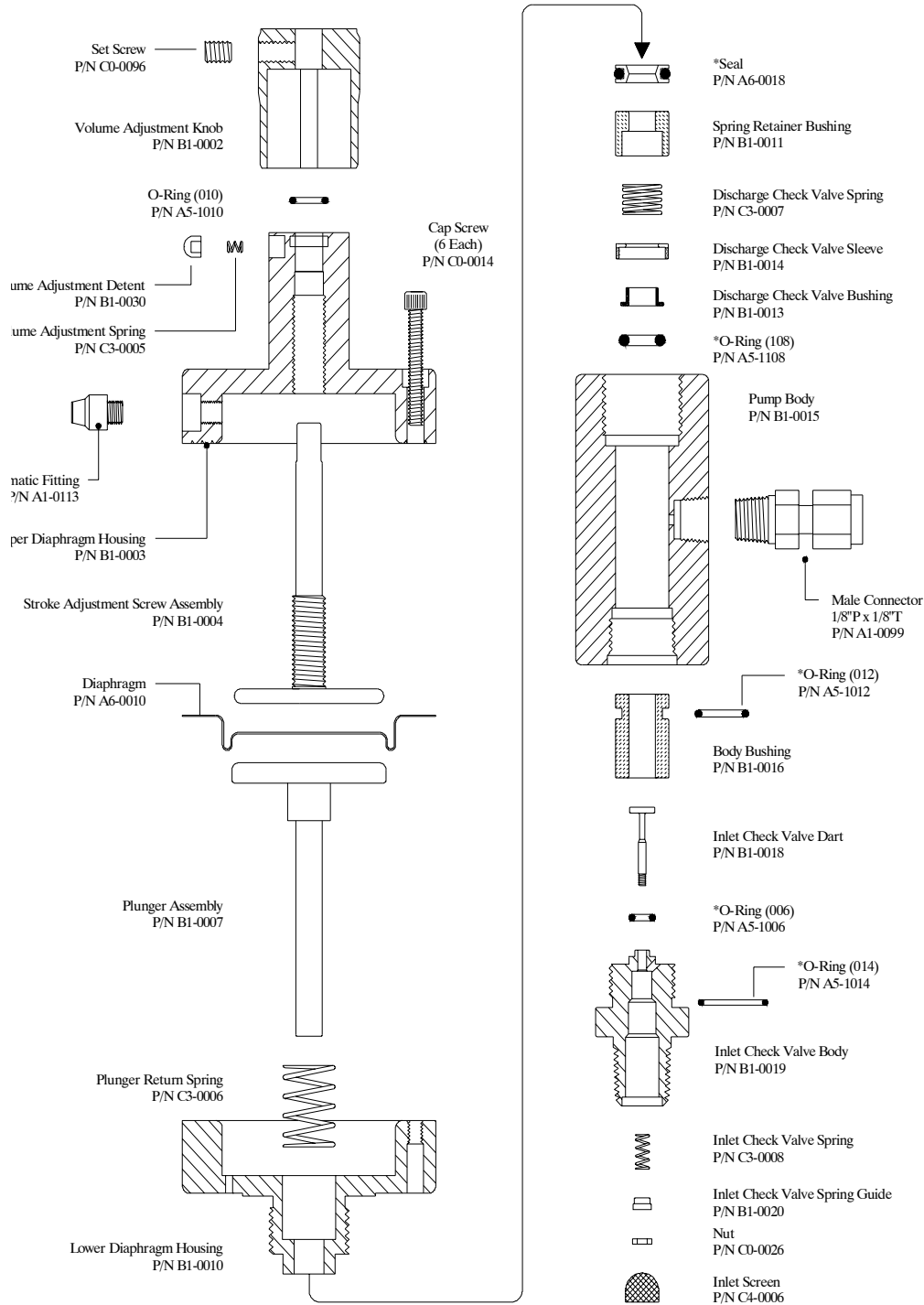

*DP-2000 Pump Seal Kit - P/N D3-0002

APPENDIX A: ILLUSTRATIONS

YZ Filter Regulator Assembly,

Figure 51

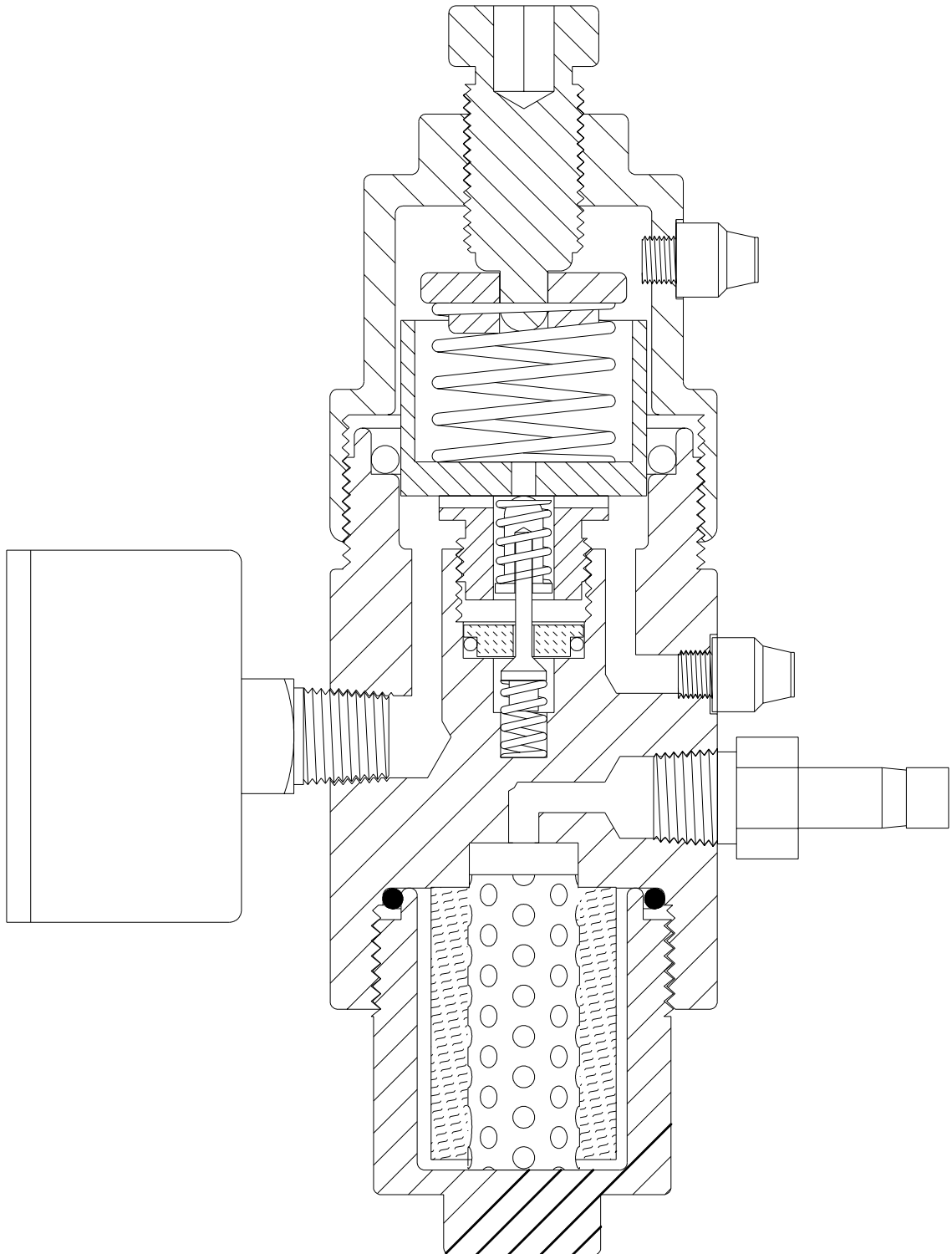

APPENDIX A: ILLUSTRATIONS

YZ Filter Regulator, Exploded View

Figure 52

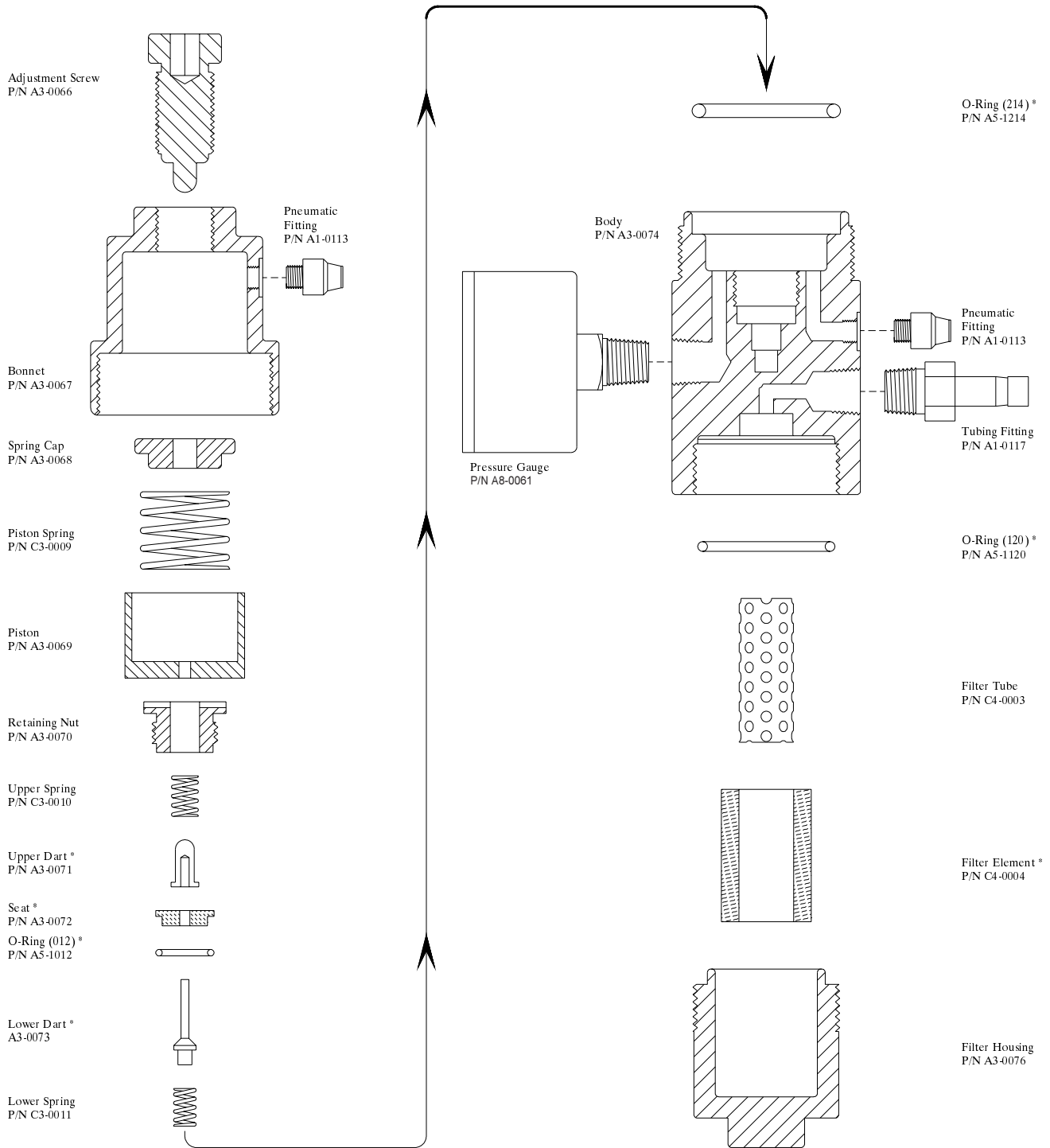

* Filter/Regulator Repair Kit P/ND3-0003

APPENDIX A: ILLUSTRATIONS

Link Plus,

Figure 53

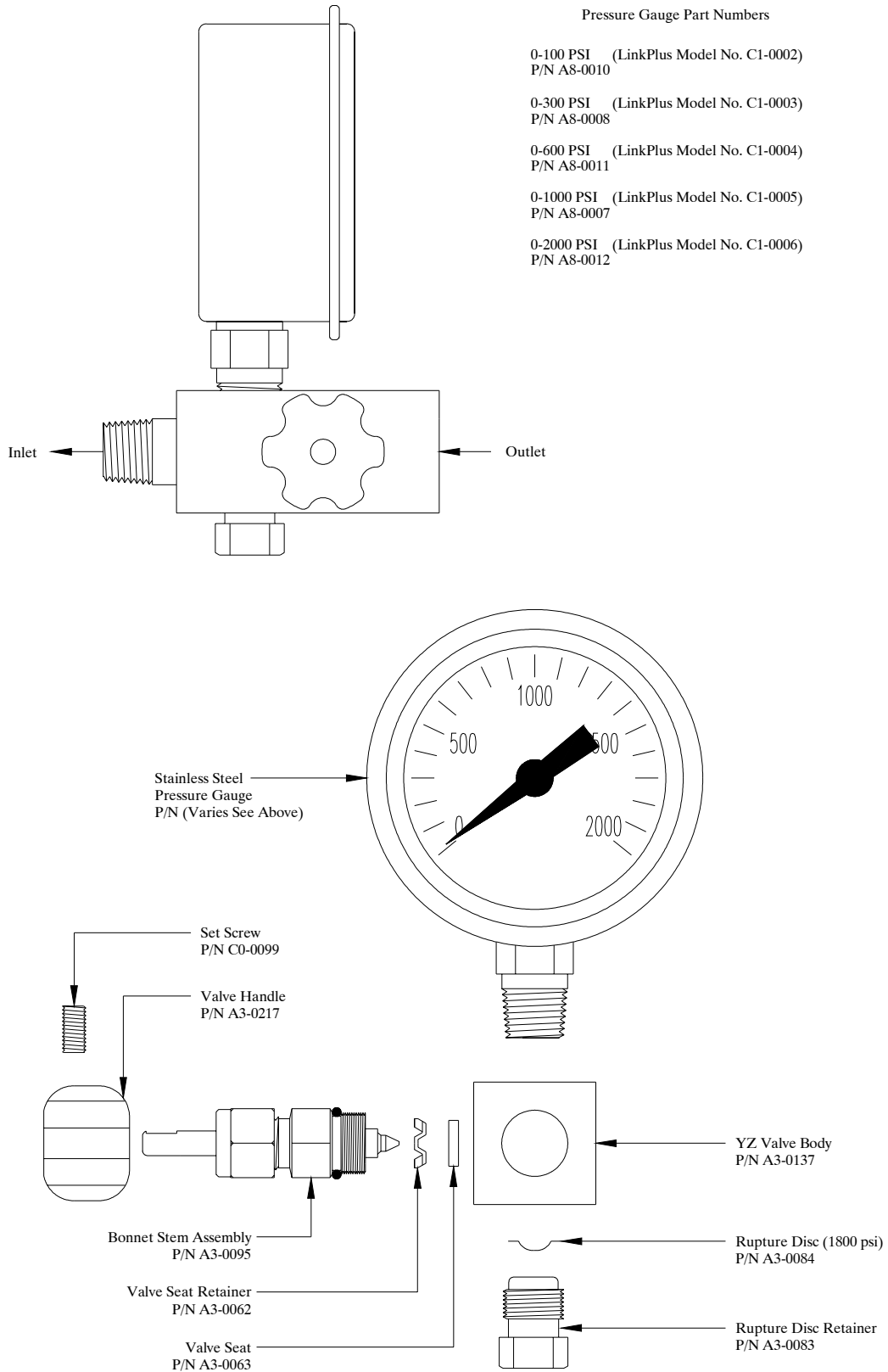

APPENDIX A: ILLUSTRATIONS

Optional DPS-2,

Figure 54

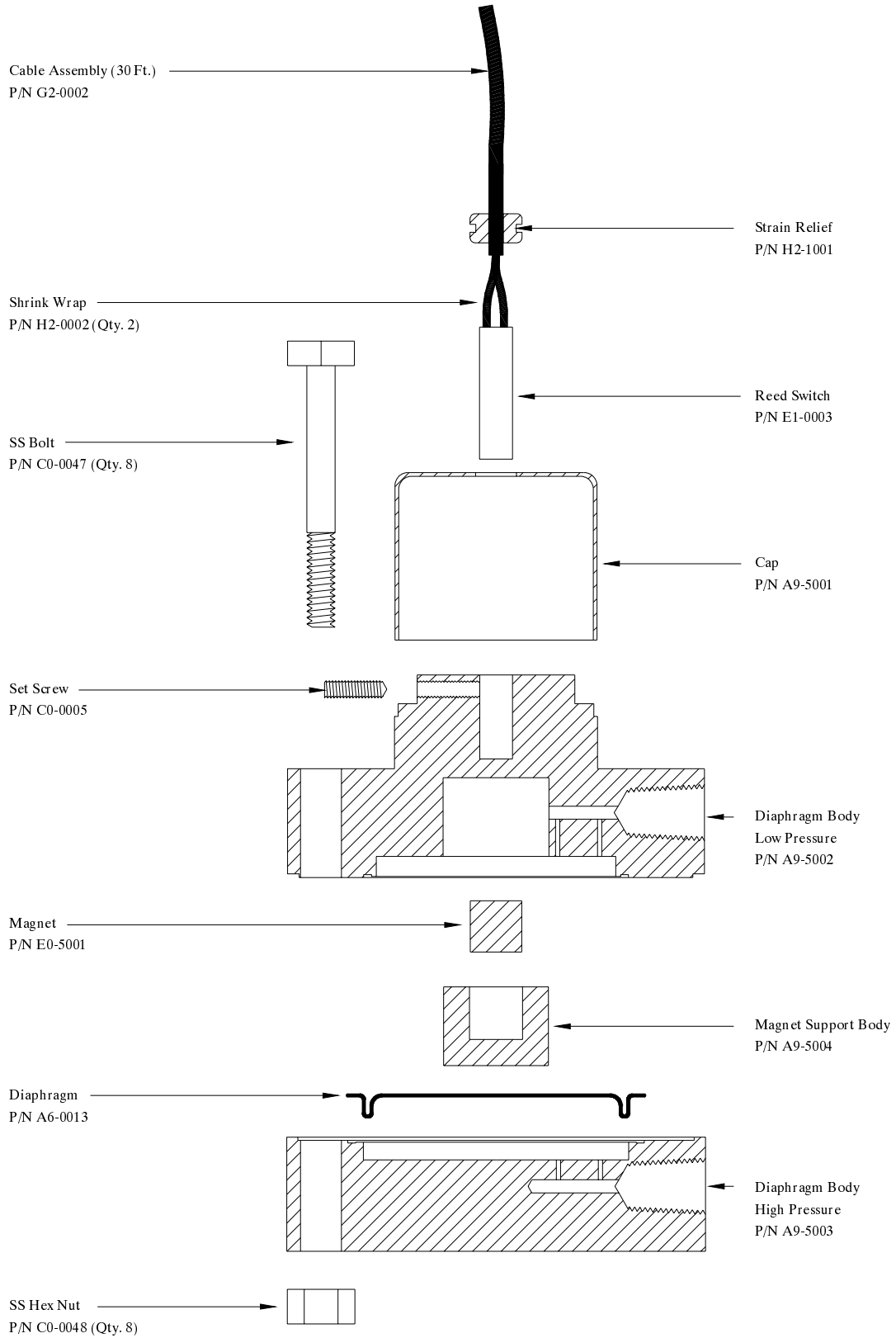

APPENDIX A: ILLUSTRATIONS

Z-65 and Solenoid,

Figure 55

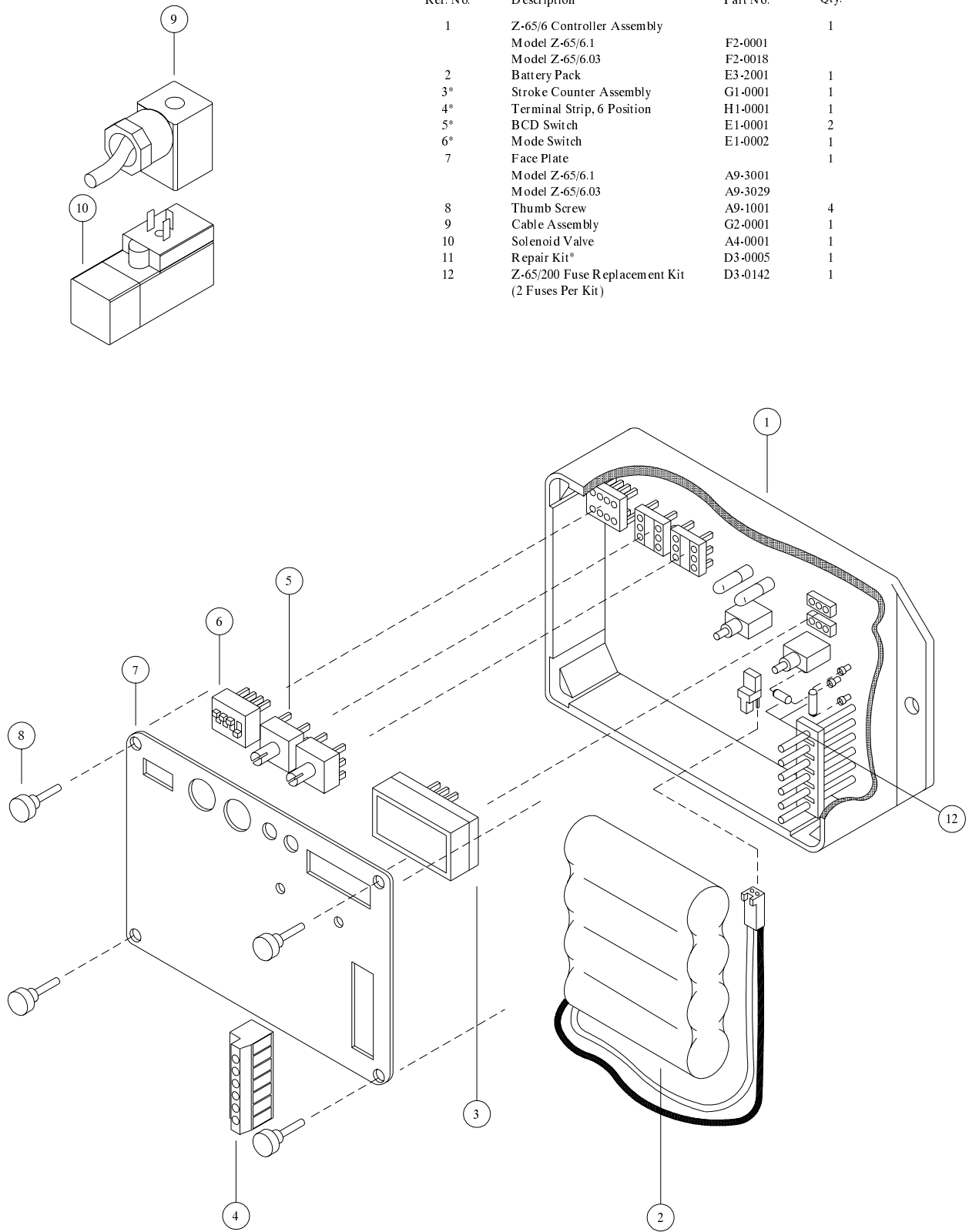

Ref. No.	Description	Part No.	Qty.
1	Z-65/6 Controller Assembly		1
	Model Z-65/6.1	F2-0001	
	Model Z-65/6.03	F2-0018	
2	Battery Pack	E3-2001	1
3*	Stroke Counter Assembly	G1-0001	1
4*	Terminal Strip, 6 Position	H1-0001	1
5*	BCD Switch	E1-0001	2
6*	Mode Switch	E1-0002	1
7	Face Plate		1
	Model Z-65/6.1	A9-3001	
	Model Z-65/6.03	A9-3029	
8	Thumb Screw	A9-1001	4
9	Cable Assembly	G2-0001	1
10	Solenoid Valve	A4-0001	1
11	Repair Kit*	D3-0005	1
12	Z-65/200 Fuse Replacement Kit	D3-0142	1
	(2 Fuses Per Kit)		

APPENDIX A: ILLUSTRATIONS

Z-65 Wiring Control Document,

Figure 56

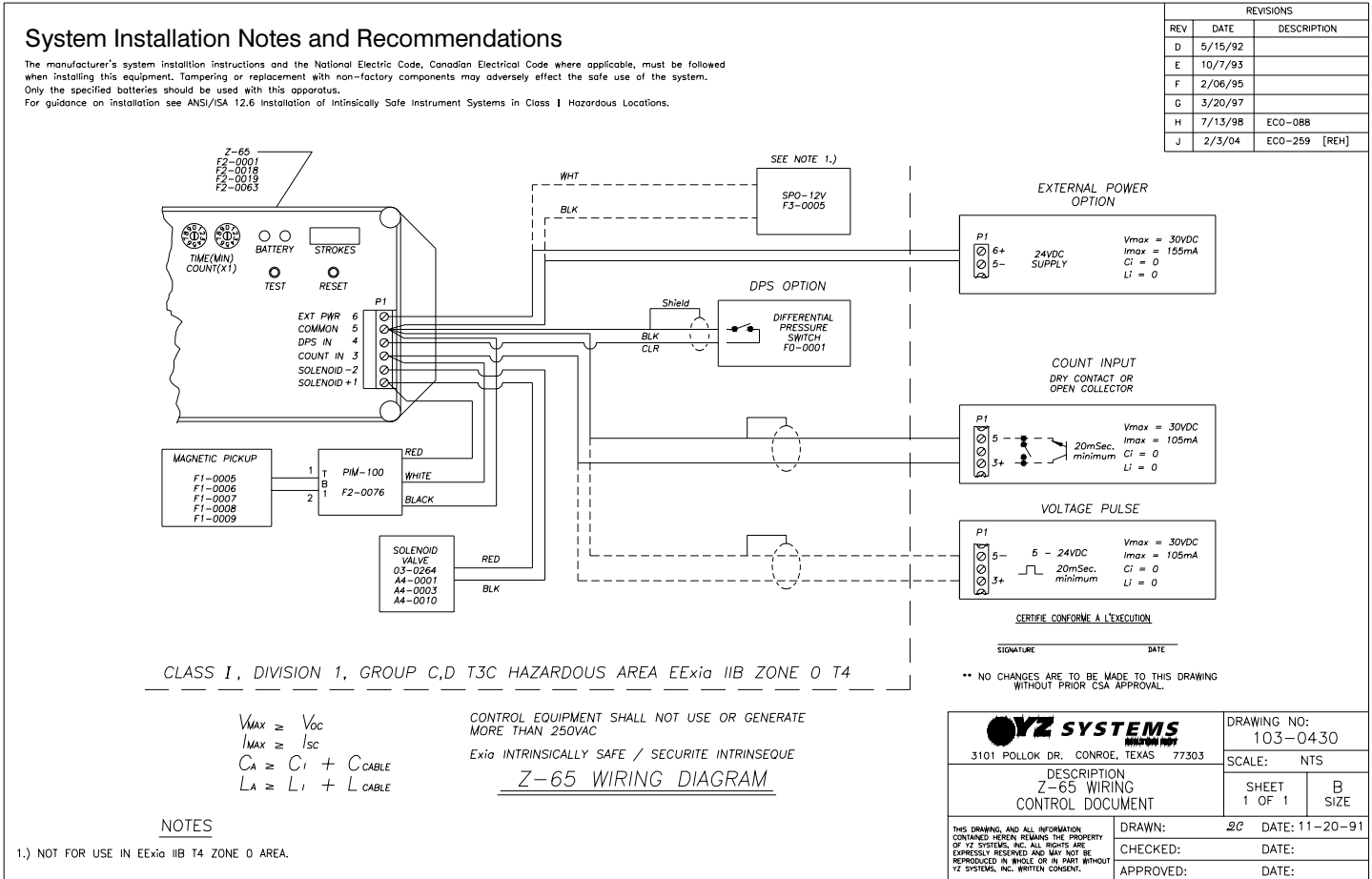

APPENDIX A: ILLUSTRATIONS

Electric Heater,

The 120 VAC Electric Heater in conjunction with a thermostatic control provides the required heat to maintain the inside of the enclosure at a temperature set by the operator.

Figure 57

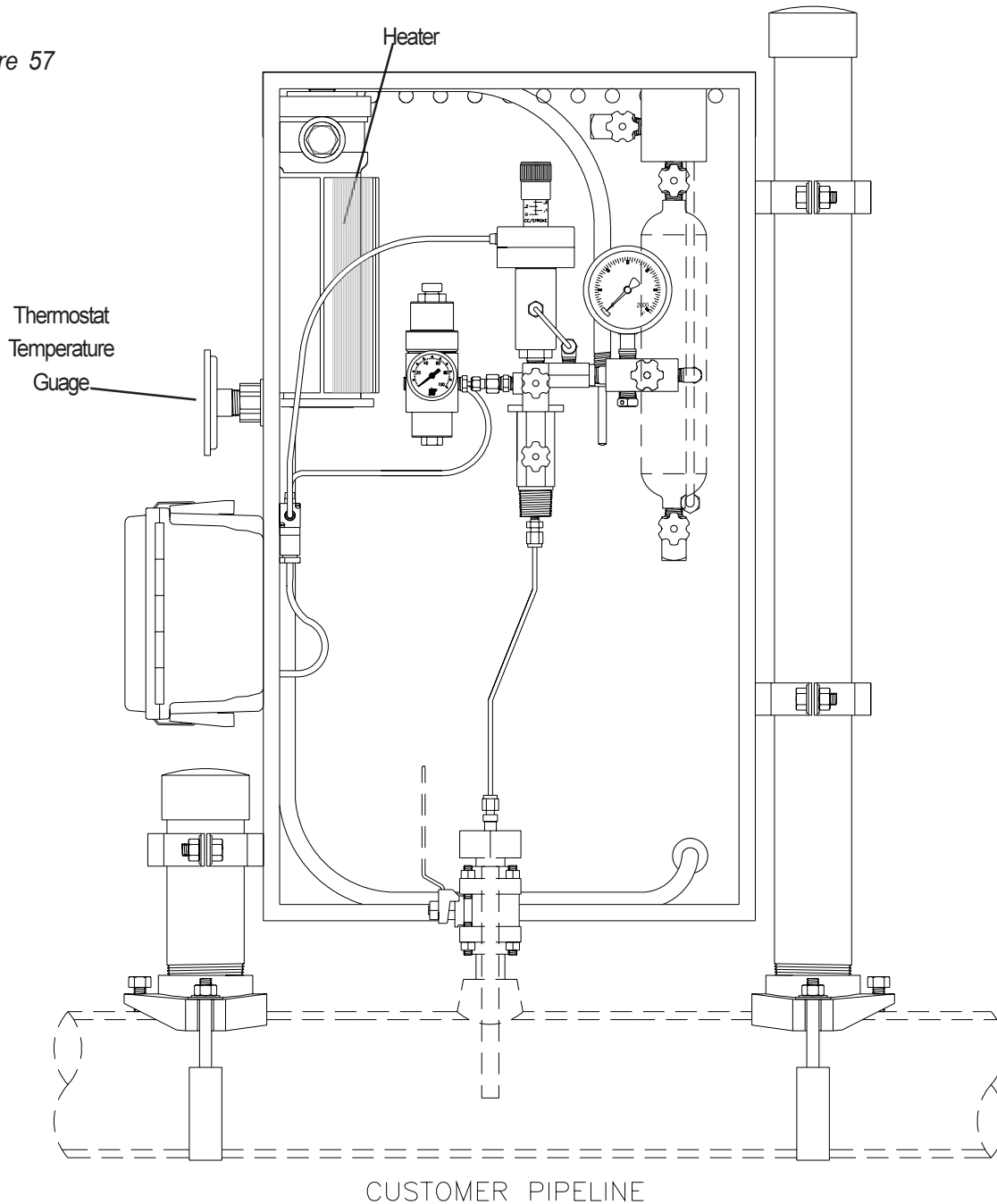

APPENDIX A: ILLUSTRATIONS

Notes

A series of horizontal lines provided for taking notes.



3101 Pollok Drive

Conroe, Texas 77303

800.653.9435

P: 936.788.5593

F: 936.788.5698

Em: Service@yzhq.com

Web: www.yzsystems.com

YZ Systems, Inc. represents and warrants that for a period of 3 years from receipt of the product: (1) the product will be free from defects in materials and workmanship; and (2) the product will perform substantially in accordance with product manuals, literature, or documentation. Any written or oral information or advice given by YZ representatives, agents, or employees will in no way increase the scope of this warranty. If the product fails to comply with the warranty set forth herein, YZ's entire liability and the customer's exclusive remedy will be replacement of the product(s) or, at YZ's option, YZ's reasonable effort to make the product meet the warranty set forth herein. **YZ disclaims all other warranties, either expressed or implied, including but not limited to, implied warranties or merchantability and fitness for a particular purpose, with respect to the product.** This limited warranty gives you specific legal rights. You may have others, which vary from state to state. **These remedies are not available outside of the United States and Canada.** In no event shall YZ or its suppliers be liable for any damages whatsoever (including, without limitation, damages for loss of profits, business interruption, loss of information, or other pecuniary loss) arising out of the use of or inability to use the product, even if YZ has been advised of the possibility of such damages. Information contained in this document is subject to change without notice and does not represent a commitment on the part of YZ Systems, Inc. All prices quoted are in U.S. dollars, F.O.B. Snyder, Texas. LINC, LINC Chemical Pumps, and LINC Level & Flow Switches are trademarks of YZ Systems, Inc. All other product names and/or registered trademarks are the property of their respective holders. YZ support services are subject to YZ's then-current prices, terms, and conditions, which are subject to change without notice. All prices and specifications, if published, are subject to change without notice.