

# DynaPak 3010 Liquid Sampling System Support Manual

Version 110195

Revision B

# Table of Contents

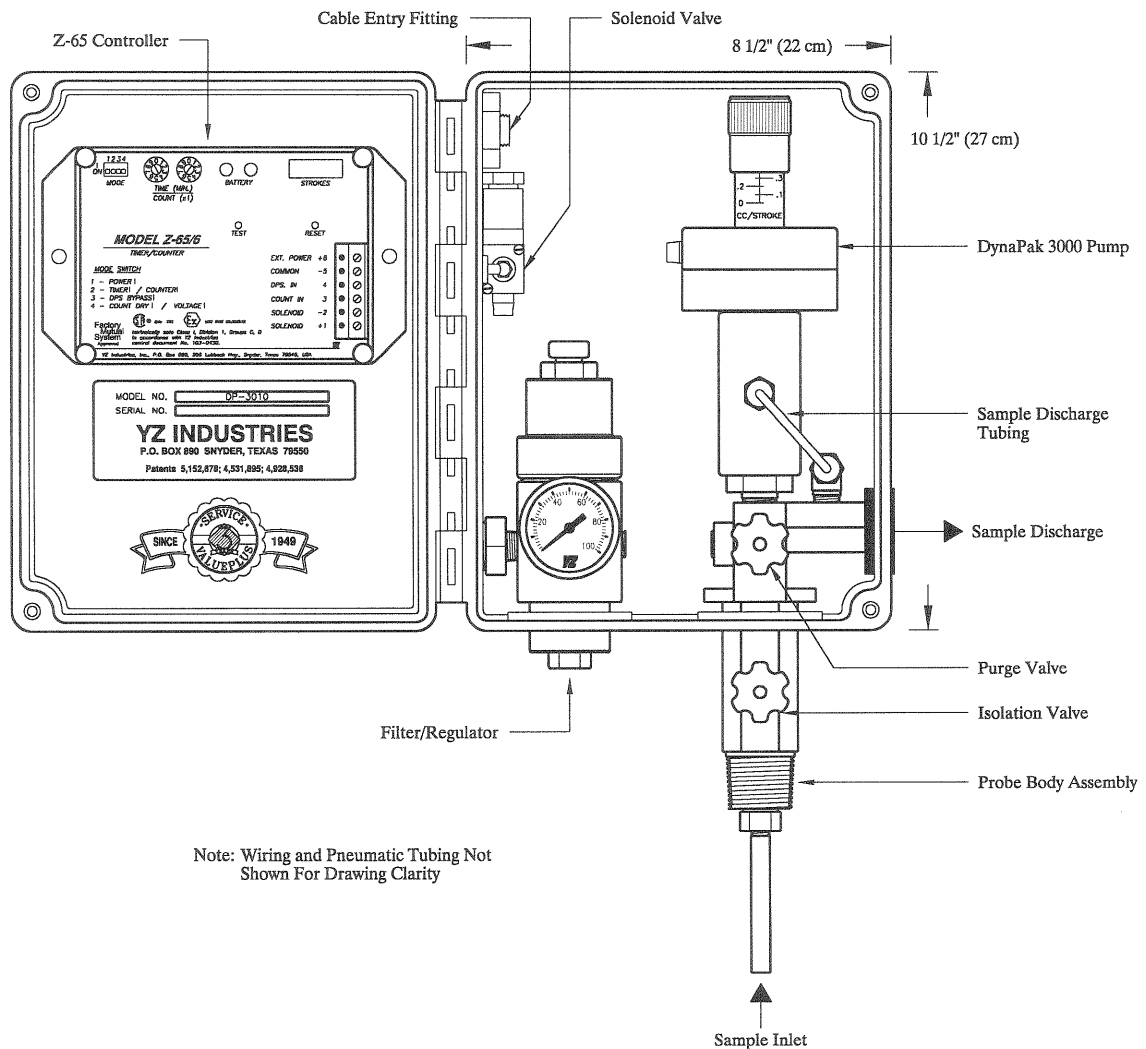
1. Introduction	3
2. System Components	3
3. Theory of Operation	4
4. System Installation	
•probe mounted unit	5
•with slipstream kit	6
•with DPS-2	7
•with SPS	8
•with pulse input	9
5. Sample Vessel Installation	10
6. Operational Checks & Leak Testing	11
7. Sampler Set-Up: Continuous time-based sampling	12
8. Sampler Set-Up: Intermittant time-based sampling with the DPS-2 or SPS	14
9. Sampler Set-Up: Continuous proportional-to-flow sampling	16
10. Sampler Set-Up: Intermittant proportional-to-flow sampling with the DPS-2 or SPS	18
11. Sampler Maintenance	20
12. Troubleshooting	24
13. Diagrams	
#1 DP-3000 pump (assembled)	28
#2 DP-3000 pump (exploded)	29
#3 YZ external actuation filter/regulator (assembled)	30
#4 YZ external actuation filter/regulator (exploded)	31
#5 Z-65/6 controller	32
#6 DPS-2	33
#7 DuraSite sample vessel instructions	34
#8 LinkPlus	36
#9 Z-65 installation notes/wiring documents	37

# 1. Introduction:

Congratulations on your purchase of the DynaPak 3010 Series Sampler. Before installation, insure that all of the components are present. You may or may not have ordered a sample cylinder with your DynaPak System. Regardless, you will need a cylinder during installation. If you have questions about installation/operation, contact your YZ representative or YZ Customer Service at 409.788.5526.

# 2. System Components:

The primary components of the DynaPak 3010 are shown here:



### 3. Theory of Operation:

## DynaPak 3010 Liquid Sampler

The DynaPak 3010 Sampler is a slipstream liquid sampling system which uses the pneumatically operated, positive displacement DynaPak 3000 pump, the Z-65/6 timer/controller, the YZ filter/regulator and a low power solenoid valve to obtain liquid samples. The 3010 has three modes of operation:

**A. Time-based sampling:** in this mode of operation, the 3010 extracts a liquid sample from the pipeline at regular time intervals. The volume of the sample is set by the operator using the volume adjustment feature of the DP-3000 pump. The Z-65/6 controller operates as a recycling timer, periodically energizing a low power solenoid valve. Energizing the solenoid valve allows externally provided actuation gas to stroke the DP-3000 pump. The rate at which this occurs is a function of operator input. Two 10 position switches are used to set the off time interval. This allows a stroke time interval of 1 - 99 minutes. The number of times the solenoid output is activated is recorded by the onboard LCD stroke indicator.

**B. Time-based sampling with the YZ differential pressure switch (DPS-2):** this mode of operation is similar to the time-based sampling mode, except that the DPS-2 converts a pressure signal to an electrical signal that the Z-65/6 timer uses to determine if flow is present in the pipeline. In effect, the DPS allows the Z-65/6 timer to shut off when flow is lost in the pipeline, and when flow is again restored, will allow the sampler to resume operation.

**C. Proportional-to-flow sampling:** in this mode of operation, the Z-65/6 counter operates as a dividing counter. The Z-65/6 counter periodically energizes a low power solenoid valve. As in the other two modes of operation, this allows actuation gas to stroke the DP-3000 pump. The

rate at which this occurs is a function of operator input as well as the host computer or other device that inputs pulses per volume metered. The two 10 position switches on the Z-65/6 are used to set the number of input pulses the counter will count before activating the solenoid output. The number of times the solenoid output is activated is recorded by the onboard LCD stroke indicator. Sample volume is again controlled using the DP-3000 volume adjustment knob.

In all three modes of operation, the Z-65/6 timer/counter operates using a replaceable internal battery pack. The battery pack condition is monitored by way of two indicator LEDs. Under normal conditions, the green indicator LED will illuminate when the solenoid output is actuated. When the battery pack needs replacement, the red LED will illuminate when the solenoid output is activated. If the battery pack is good, the green LED will illuminate when the solenoid is activated.

The **External Power Option** may be used in lieu of the internal battery pack. The External Power Option (model No. EPO-120) consists of a AC to DC convertor and intrinsically safe barrier to convert 120 VAC power to 28 VDC to operate the controller without the use of the internal battery pack.

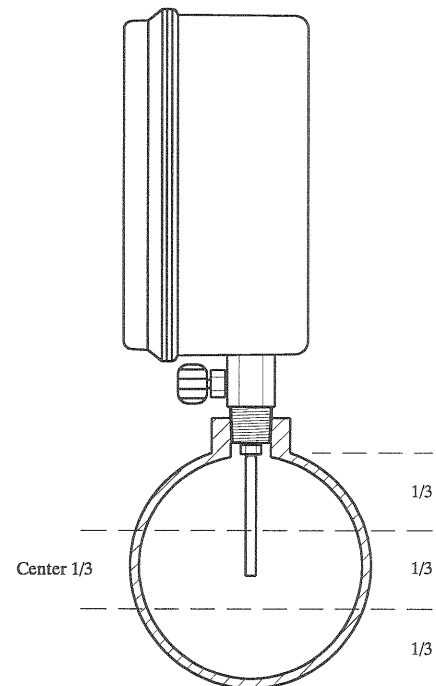
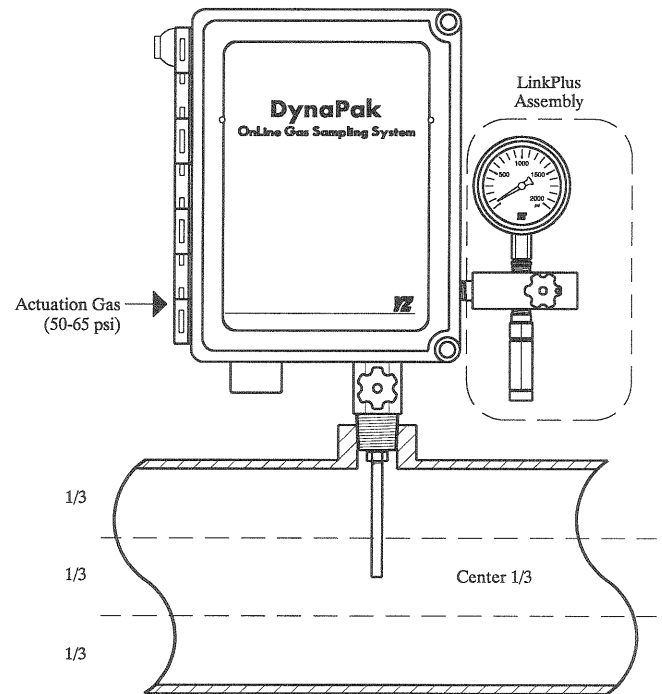
The **Solar Power Option** would be used in lieu of the internal battery pack. The **Solar Power Option** (model #SPO-12) consists of a 5 watt solar panel with RM-12 charger regulator module and internal 12V, 5 Amp hour battery pack.

## 4. System Installation:

### 4.1 Probe Mounted DynaPak 3010

- a. The DynaPak 3010 requires a 3/4" FNPT pipeline connection.
- b. The sampler should be mounted vertically in a horizontal run of the pipeline.
- c. The end of the sampler probe should penetrate the center 1/3rd of the pipeline.
- d. The end of the sample probe should be cut parallel to the pipeline.
- e. Connect the actuation gas supply (50 - 65psi) to the actuation gas connection located on the left hand side of the sampler.
- f. Connect the sample out connection to the sample vessel.
- g. Wire the Z-65/6 to the flow input device (DPS-2, SPS, Pulse Input) to be used. Wiring instructions are found in sections 4.3, 4.4 and 4.5.
- h. Before applying pipeline pressure to the DynaPak 3010, ensure that the product supply valve is closed.
- i. After pipeline pressure has been applied to the sampler, check the probe body/pipeline connection for leaks.
- j. Open the product supply valve.
- k. Follow the operational "check and leak test" detailed in section 6.

NOTE: if direct probe mounting to the line is not possible, a slipstream conversion mounting kit (Part No. D3-0016) may be purchased. See section 4.2 for installation instructions.



## 4. System Installation:

### 4.2 DynaPak-3010 With Slipstream Kit

a. Mount the DP-3010 with slipstream kit on a vertical 2" pole.

b. Connect the slipstream adapter to the pipeline product supply and product return connections as shown in the diagram.

c. Connect the actuation gas supply (50 - 65psi) to the actuation gas connection located on the left hand side of the sampler.

d. Connect the sample out connection to the sample vessel.

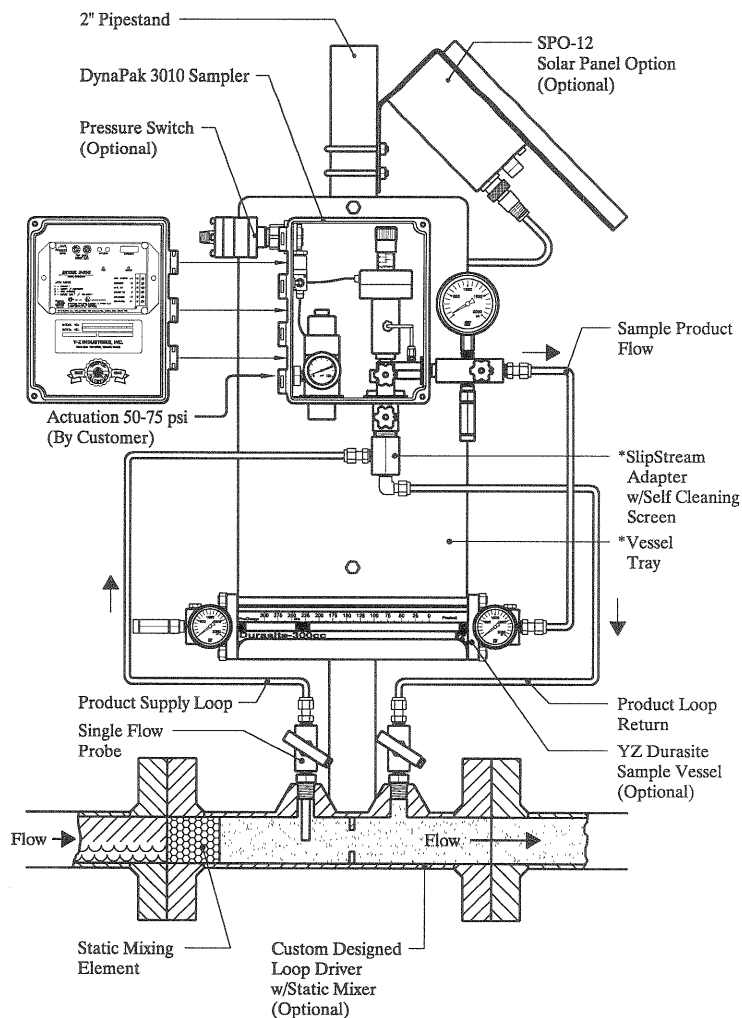
e. Wire the Z-65/6 to the flow input device (DPS-2, SPS, Pulse Input) to be used. Wiring instructions are found in sections 4.3, 4.4 and 4.5.

f. Before applying pipeline pressure to the DP-3010, ensure that the product supply valve is closed.

g. After pipeline pressure has been applied to the sampler, check the slipstream tubing connections for leaks.

h. Open the product supply valve.

i. Follow the "Operational Check and Leak Testing Procedures" detailed in Section 6.



\* Denotes Items Included in DP-3010 SlipStream Adapter Kit

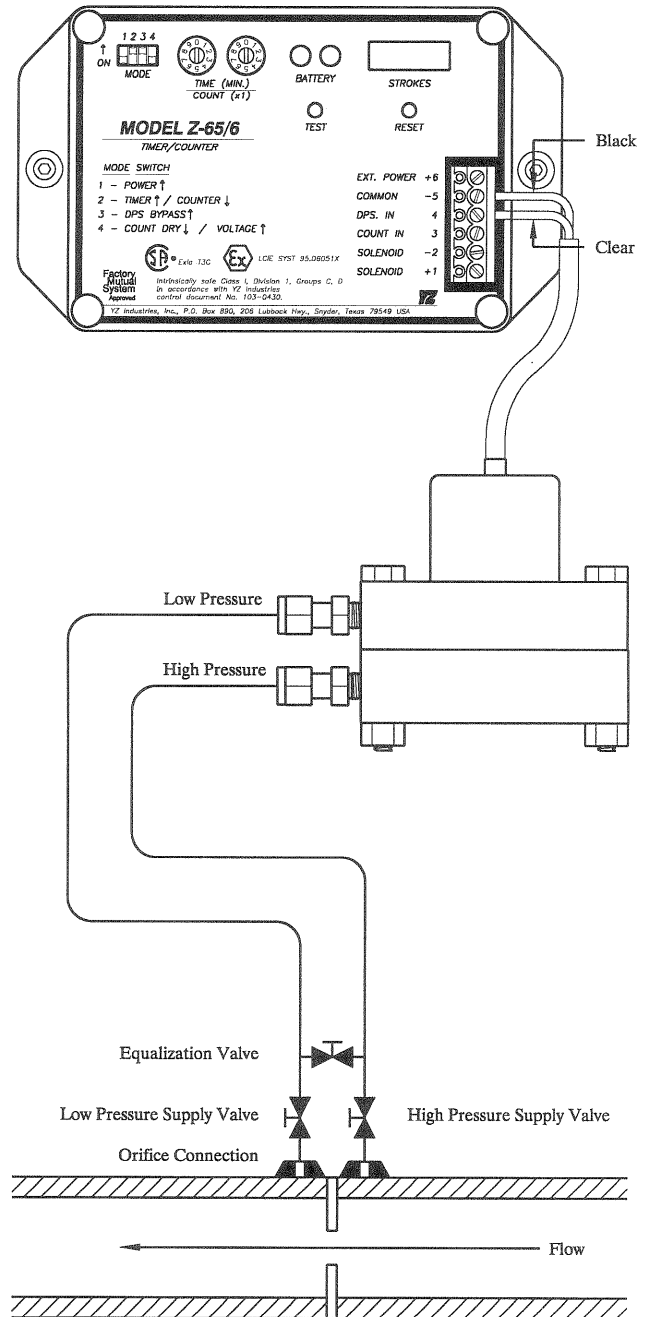
## 4. System Installation:

### 4.3 DPS-2

- a. With the low pressure supply valve and the high pressure supply valve closed, connect the DPS-2 to the orifice connection tubing.
- b. Open the equalization valve.
- c. Open the low pressure supply valve or the high pressure supply valve.

*NOTE: Do not open either the low pressure supply valve or the high pressure supply valve without ensuring that the equalization valve is open. Failure to do so may damage the DPS-2's internal components.*

- d. Open the other supply valve.
- e. Close the equalization valve.
- f. Run the free end of the DPS-2 cable through the cable entry connector located on the upper left side on the DynaPak 3010 enclosure.
- g. Connect the DPS-2 cable as shown in the diagram.
- h. Tighten the cable entry connector, allowing for enough cable length to open the enclosure.



## 4. System Installation:

### 4.4 Static Pressure Switch (SPS)

Install the SPS when a static pressure signal is used to initiate the DP-3010 sampler.

The SPS allows the Z-65/6 controller to begin the time-based sampling cycle each time a pressure signal is received or to accumulate a predetermined number of pressure signals before the sampling cycle begins.

#### Option 1:

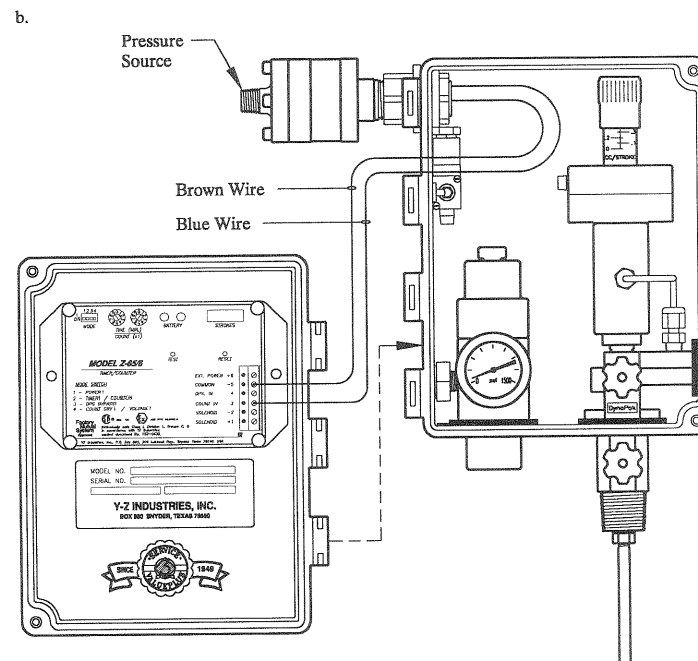
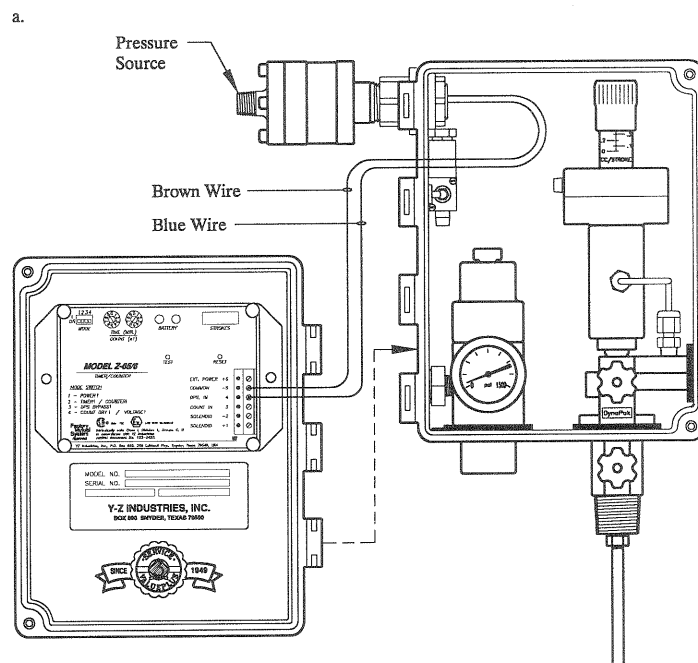
a. Time Based Sampling at each pressure signal (section 8):

1. Connect the pressure source to the 1/4" male NPT connection located on the left hand side of the SPS.
2. Connect the brown wire on the SPS to terminal #5 on the Z-65/6 (This connection is made at the factory).
3. Connect the blue wire on the SPS to terminal #4 on the Z-65/6 (Field connection).

#### Option 2:

b. Proportional-To-Flow Sampling at predetermined number of pressure signals (section 10):

1. Connect the pressure source to the 1/4" male NPT connection located on the left hand side of the SPS.
2. Connect the brown wire on the SPS to terminal #5 on the Z-65/6 (This connection is made at the factory).
3. Connect the blue wire on the SPS to terminal #3 on the Z-65/6 (Field connection).





## 4. System Installation:

### 4.5 Pulse Input

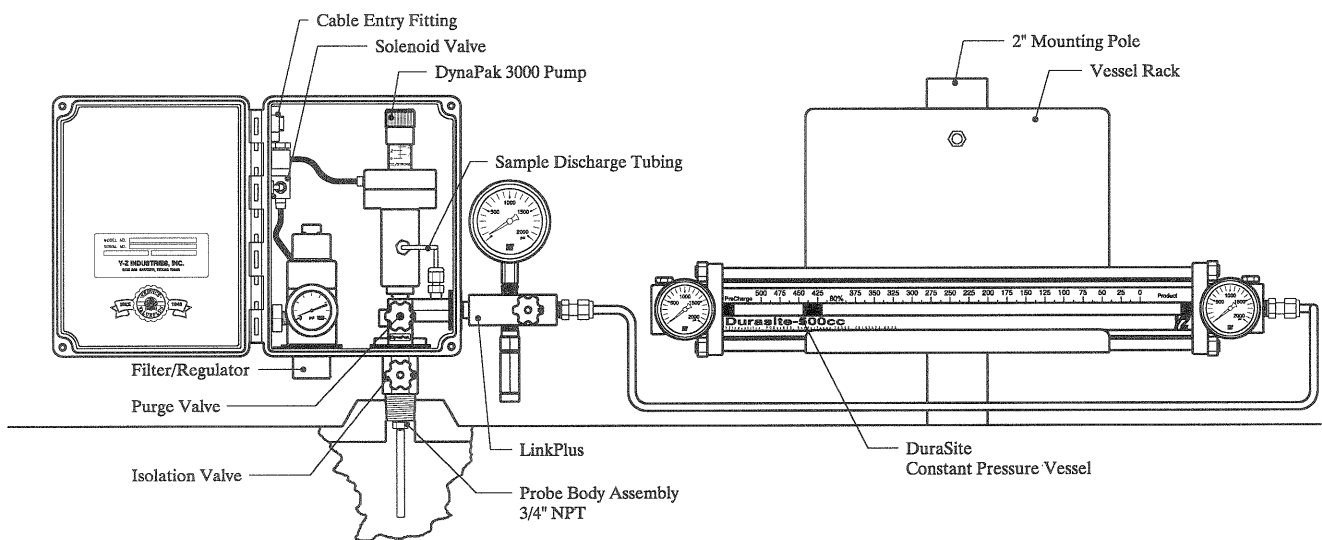
In the counter mode, the Z-65/6 is designed to energize the sample pump solenoid once the preset number of pulses are received. The rate at which this occurs is a function of the pipeline flow rate and the metered volume per pulse. For wiring instructions see section 9.

## 5. Sample Vessel Installation:

The free-floating piston cylinder (DuraSite) may be installed in a horizontal position on an optional vessel rack.

Install 1/8" tubing from the sample discharge port of the manifold to the product end of the vessel. Avoid traps in this line.

The vessel may be pre-charged by using bottled inert gas such as nitrogen or helium (consult the factory for proper procedure).



## 6. Operational Check & Leak Testing:

6.1 When all of the tubing connections have been completed, close the purge valve on the front of the sampler probe body. Open the sample probe supply valve to establish product supply pressure to the probe body. Check all connections for leaks.

6.2 Adjust the filter/regulator from the following ranges:

Pipeline Pressure	Actuation Pressure
Under 700 psig (48 Bar)	50 (3.5 Bar)
Over 700 psig (48 Bar)	65 (4.5 Bar)

6.3 Turn the stroke adjustment knob on the top of the pump counterclockwise to set the pump displacement at .4cc/stroke.

6.4 Move all of the mode switches on the Z-65/6 to their off positions.

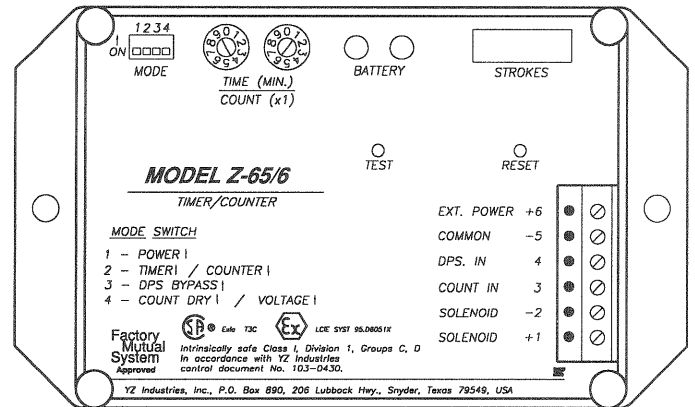
6.5 Move both timer/counter dials to the 0 position (00 minutes).

6.6 Move mode switches 1, 2 and 3 to the on position.

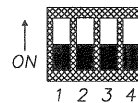
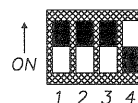
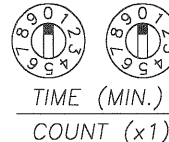
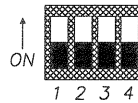
6.7 Pump actuation will begin as the solenoid valve is energized by the Z-65/6. Allow the sampler to operate until the desired stabilized pressure is achieved at the sample discharge.

6.8 Check all connections from the sampler discharge to the sample cylinder for leaks.

6.9 Once finished with the leak test, return the mode switches to their off positions.



**NOTE:** black illustrates position of switches.

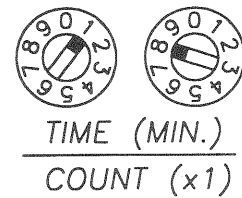


## 7. Sampler Set-Up: Continuous time-based sampling

7.1 Calculate the sampling rate using the following chart:

Number of turns open on pump stroke knob	sample pump displacement per stroke	Sample cylinder volumes			sample rate (minutes)
		1 0 0 0 c c	5 0 0 c c	3 0 0 c c	
3	.100	4	9	15	
6	.200	9	18	30	
9	.300	13	27	45	
12	.400	18	36	60	

7.2 Set the timer dials on the Z-65/6 to the sample rate from step 7.1.

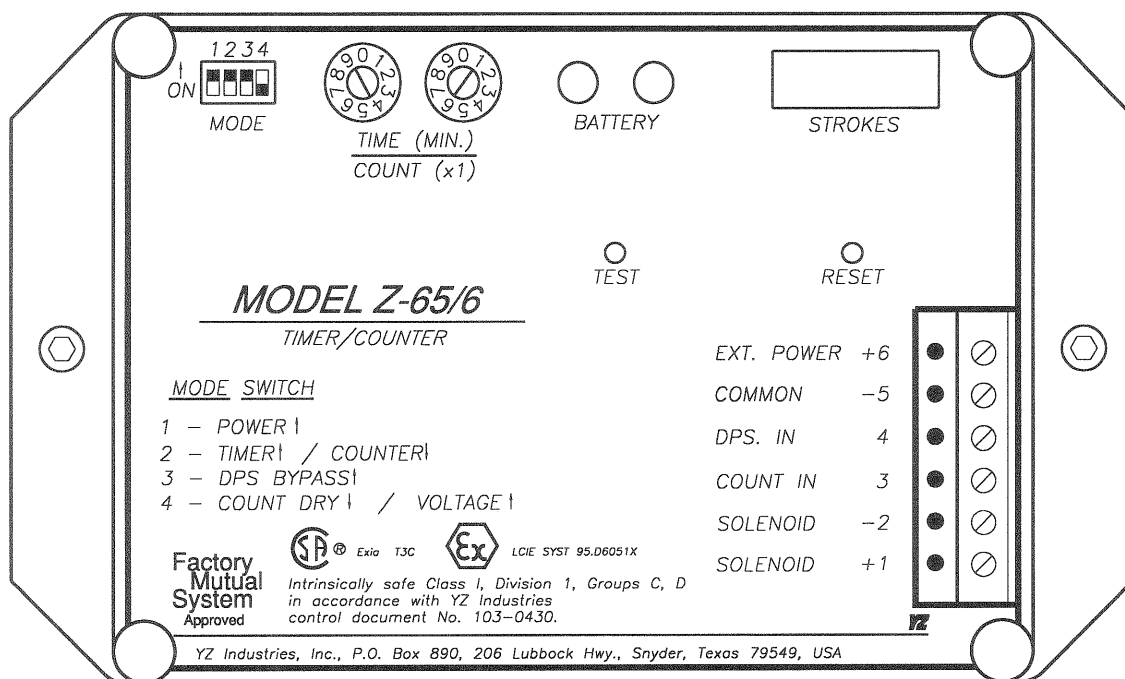


*NOTE: to obtain maximum battery life, choose the longest time interval and largest pump displacement setting possible.*

*NOTE: The time (18 minutes) above corresponds to the dial setting shown for the Z-65/6.1 model with the timer range setting in the factory position (jumper on the two left pins). See section 12.4 Timer Range Setting.*

7.3 Adjust the pump volume adjustment knob to the value used in the calculations in step 7.1.

Sample pump displacement per stroke	Number of turns open on the pump volume knob
.1cc	3
.2cc	6
.4cc	12



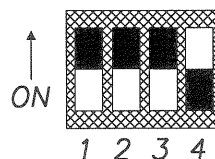
7.4 Turn mode switch 1 to on.

7.5 Turn mode switch 2 to on.

7.6 Turn mode switch 3 to on.

7.7 Turn mode switch 4 to off.

7.8 Press the test button once to initiate the timer sequence.



## 8. Sampler set-up: Intermittant time-based sampling with the DPS-2 or SPS (low production)

In this mode of operation, the DP-3010 samples proportional-to-time during periods when flow is present in the pipeline. This method of sampling is used for low production condensate platforms.

8.1 Calculate the sampling rate using the following equation:

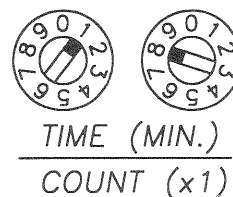
Pump displacement (cc/stroke)	=	a.
Daily production (Bbls/day)	=	b.
Sample period length (days)	=	c.
Dump cycle volume (Bbls/dump)	=	d.
Desired sample volume (cc)	=	e.
Dump cycle duration (min/dump)	=	f.

$$\text{Timer Setting} = \frac{a \times b \times c \times f}{d \times e}$$

Example:

Pump displacement	=	.4cc/stroke
Daily production	=	6 Bbls/day
Sample period length	=	30 days
Dump cycle volume	=	.3 Bbls/dump
Desired sample volume	=	400 cc
Dump cycle duration	=	10 minutes/dump

$$\text{Timer Setting} = \frac{.4 \times 6 \times 30 \times 10}{.3 \times 400} = 6 \text{ minutes}$$



**NOTE: if the timer setting calculated is greater than the dump cycle duration, use the high intermittent proportional-to-flow sampling with the DPS-2 or SPS (high production) shown in section 10.**

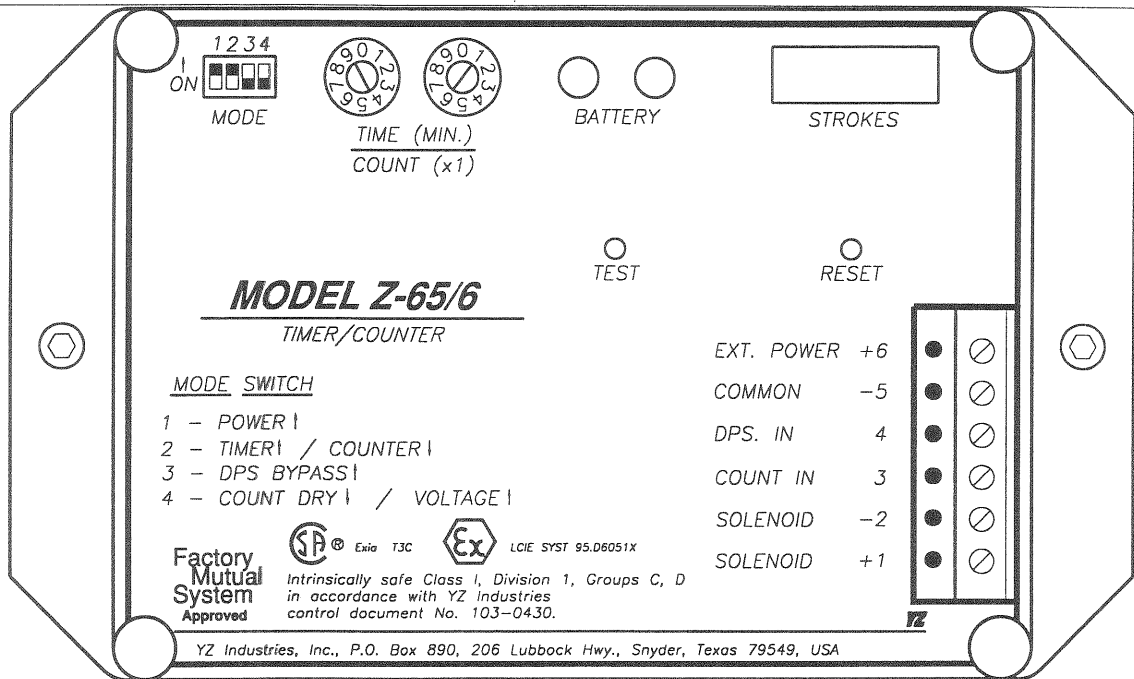
8.2 Set the timer dials on the Z-65/6 to the sample rate from step 8.1.

**NOTE: to obtain maximum battery life, choose the longest time interval and largest pump displacement setting possible.**

**NOTE: The time (18 minutes) above corresponds to the dial setting shown for the Z-65/6.1 model with the timer range setting in the factory position (jumper on the two left pins). See section 12.4 Timer Range Setting.**

8.3 Adjust the pump volume adjustment knob to the value used in the calculations in step 8.1.

Sample pump displacement per stroke	Number of turns open on the pump volume knob
.1cc	3
.2cc	6
.4cc	12

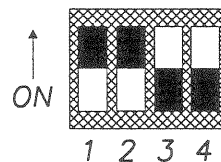


8.4 Turn mode switch 1 to on.

8.5 Turn mode switch 2 to on.

8.6 Turn mode switch 3 to off.

8.7 Turn mode switch 4 to off.



8.8 Press the test button once to initiate the timer sequence.

*NOTE: for the Z-65/6 to operate the DP-3010 System, a pressure differential of 3" of water must exist between the high pressure and low pressure ports of the DPS-2.*

*Actuation pressure for the SPS is factory set at 15psi.*

## 9. Sampler set-up: Continuous proportional-to-flow sampling

In this mode of operation, the Z-65/6 controller is used as a dividing counter to control the rate at which the pump is actuated. The desired time between pump strokes is controlled by the host computer or output device that will give an input pulse to the Z-65/6 controller.

9.1 Calculate the counter setting for continuous flow pipelines using the following chart:

1. your pump displacement (from .1 to .4cc's)	=	a. _____
2. your sample cylinder volume in cc's (300cc, 500cc, etc.)	=	b. _____
3. average flow rate (Bbl per day)	=	c. _____
4. sample period in days	=	d. _____
5. pulses per volume metered (pulses per Bbl)	=	e. _____
6. counter setting	=	$\frac{a \times c \times d \times e}{(b)}$

**EXAMPLE:**

pump displacement	(a.)	=	.2cc
sample cylinder size	(b.)	=	300cc
average flow rate	(c.)	=	100 Bbl per day
sample period	(d.)	=	30 days
pulses per volume metered	(e.)	=	10 pulses per Bbl

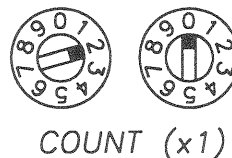
**counter setting** =  $\frac{.2cc \times 100 \text{ Bbl/day} \times 30 \text{ days} \times 10 \text{ pulses/Bbl}}{300 \text{ cc}}$  = **20 pulses**

9.2 Turn the count dials to the appropriate number of pulses you want to count before the sample pump strokes.

Example: 20 pulses; turn dials to 20.

Press the test button once to load the value into the memory.

*NOTE: if the calculated counter setting is less than 1 or greater than 99, the pulses per volume metered will need to be adjusted. This can be programmed in most flow meters to the desired rate. If the calculated counter setting is less than 1, increase the pulses per volume metered. If the calculated counter setting is greater than 99, decrease the pulses per volume metered.*





9.3 Adjust the pump volume adjustment knob to the value used in the calculation in step 9.1.

Sample pump displacement per stroke	Number of turns open on the pump volume knob
.1cc	3
.2cc	6
.4cc	12

9.4 Determine if the incoming input is either a dry contact or voltage pulse.

**9.5 If the input is a dry contact:**

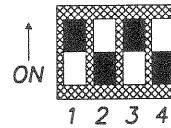
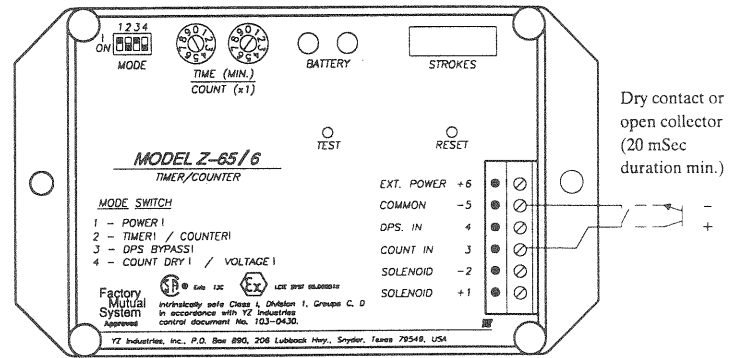
a. terminate the incoming connections to the Z-65/6 terminal strip (see illustration).

b. Turn mode switch 1 to on.

c. Turn mode switch 2 to off.

d. Turn mode switch 3 to on.

e. Turn mode switch 4 to off.



**OR**

**If the input is a voltage pulse:**

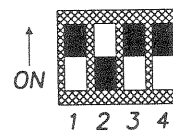
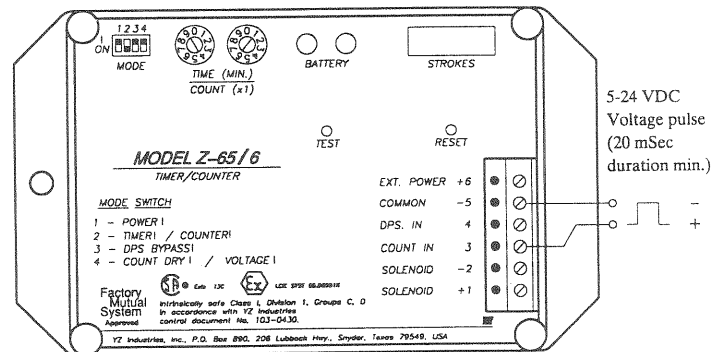
a. Terminate the incoming connections to the Z-65/6 terminal strip (see illustration).

b. Turn mode switch 1 to on.

c. Turn mode switch 2 to off.

d. Turn mode switch 3 to on.

e. Turn mode switch 4 to on.



## 10. Sampler set-up: Intermittant proportional-to-flow sampling with the DPS-2 or SPS (high production)

In this mode of operation, the DP-3010 samples proportional-to-flow based upon the number of times the DPS-2 or SPS indicates pipeline flow.

10.1 Calculate the sampling rate using the following equation:

Pump displacement (cc/stroke)	=	a.
Daily production (Bbls/day)	=	b.
Sample period length (days)	=	c.
Dump cycle volume (Bbls/dump)	=	d.
Dump sample volume (cc)	=	e.

$$\text{Counter Setting} = \frac{a \times b \times c}{d \times e}$$

Example:

Pump displacement	=	.4cc/stroke
Daily production	=	100 Bbls/day
Sample period length	=	30 days
Dump cycle volume	=	.3 Bbls/dump
Desired sample volume	=	400 cc

$$\text{Counter Setting} = \frac{.4 \times 100 \times 30}{.3 \times 400} = 10$$

**NOTE: if the timer setting calculated is less than 1, use intermittent time based sampling with the DPS-2 or SPS (low production) shown in section 8.**

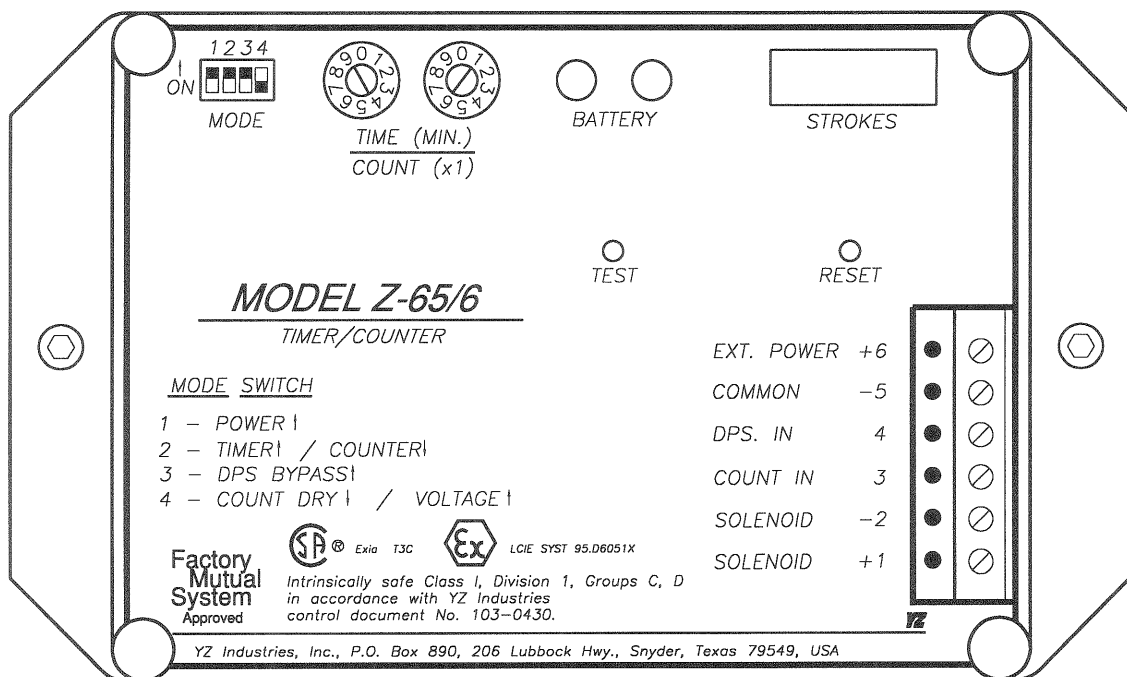
10.2 Set the count dials to the appropriate number of pulses you want to count before the sample pump strokes.

Example: 20 pulses; turn dials to 20.

Press the test button once to load the value into the memory.

10.3 Adjust the pump volume adjustment knob to the value used in the calculations in step 9.1.

Sample pump displacement per stroke	Number of turns open on the pump volume knob
.1cc	3
.2cc	6
.4cc	12

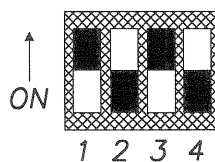


10.4 Turn mode switch 1 to on.

10.5 Turn mode switch 2 to off.

10.6 Turn mode switch 3 to on.

10.7 Turn mode switch 4 to off.



## 11. Sampler maintenance:

### 11.1 Recommended preventative maintenance schedule

Every sampling situation is unique. Below are our recommendations for average conditions.

- a. Clean and lubricate the sample pump every six months.
- b. Check the filter element every six months replacing as necessary.
- c. Test the battery every six months.
- d. Test the system for leaks each time a fitting or connection has been made.

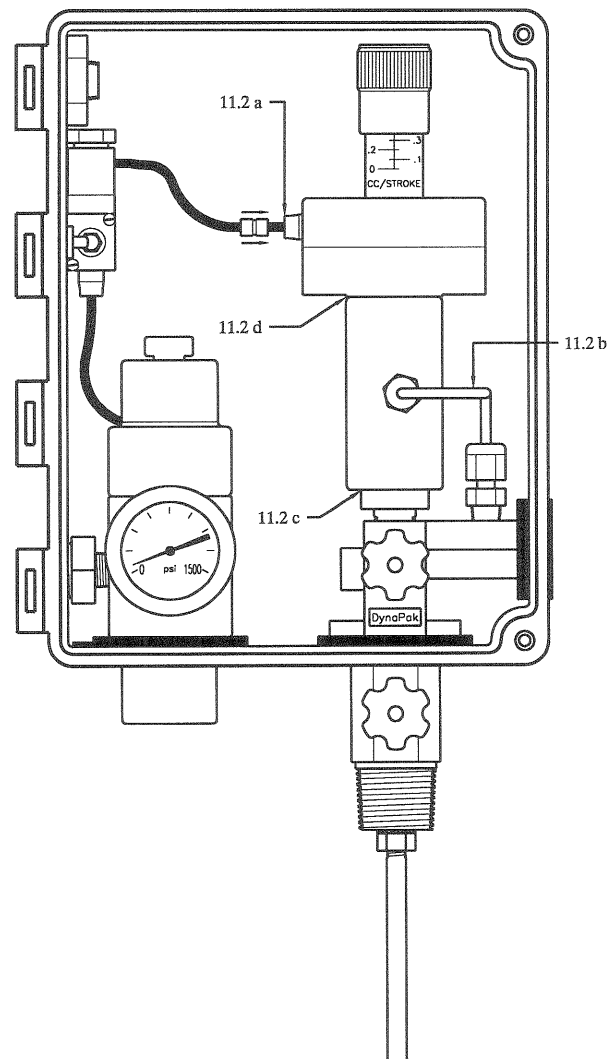
### 11.2 Cleaning and lubricating the DP-3000 pump

- a. Disconnect the plastic tubing from the solenoid valve to the pump diaphragm housing by depressing the tubing release sleeve on the diaphragm housing fitting while pulling out the tubing. It is not necessary to remove the fitting from the diaphragm housing.
- b. Remove the sample discharge (1/8" stainless steel tubing) from the pump body.
- c. Unscrew the pump body from the inlet check valve assembly. Separation at this point is recommended to maintain proper tubing location and alignment between the pump body and the probe body. Do not remove the inlet check valve body from the manifold unless cleaning is necessary. To replace the inlet check valve o-ring, cut the o-ring off the head of the dart and stretch the new o-ring over the head of the dart using a light coat of assembly grease.
- d. Remove the diaphragm housing from the pump body by unscrewing the diaphragm housing and carefully pulling the plunger out of the pump body. Inspect the plunger shaft for damage or wear. The diaphragm chamber houses the dia-

phragm, return spring and plunger assembly. The diaphragm chamber should not be disassembled unless one of these items needs replacing.

- e. Remove the internal bushings and o-rings from the pump body by inserting a non-metallic rod (larger than 1/4", smaller than 1/2") into the top of the pump body. Gently tap to remove all bushings and o-rings out the bottom of the pump body.
- f. Clean and inspect all components. Replace if necessary.

*NOTE: normal service generally requires only the replacement of the o-rings and seal. A seal repair kit (part number D3-0002) is available from YZ.*



g. Apply a light coat of non-soluble assembly grease on all o-rings and bushings to prevent damage.

h. Install the body bushing into the bottom of the pump body.

i. Insert all other bushings, springs, and o-rings in their respective sequence on the plunger shaft.

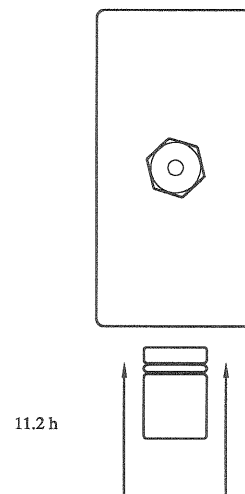
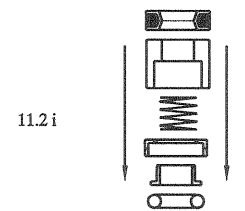
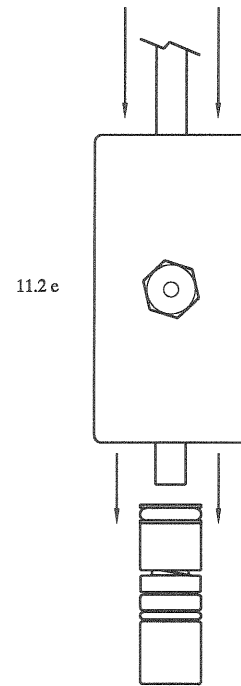
j. Carefully install the diaphragm housing assembly into the top of the pump body.

*NOTE: apply a light coat of assembly grease on the plunger shaft prior to installation.*

k. Install the pump assembly on the inlet valve assembly.

l. Connect the 1/8" stainless steel tubing to the pump body and 1/8" plastic tubing to the diaphragm housing.

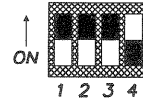
m. Pressure test the pump as previously described for proper operation.



### 11.3 Battery Test:

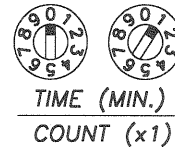
a. Set the mode switches as follows:

1. Position 1, 2 and 3 on



b. Set the time switches to the 01 position.

*NOTE: time switches must not be in 00 position to test the battery.*



This will set the solenoid output rate to one actuation every one minute (based on the factory set time range for the Z-65/6.1 model).

c. Depress the test switch to test the battery. A green LED will illuminate if the battery is good and a red LED will illuminate if the battery is low.

*NOTE: the solenoid must be connected to test the battery condition. **Battery condition cannot be tested with a volt meter.***

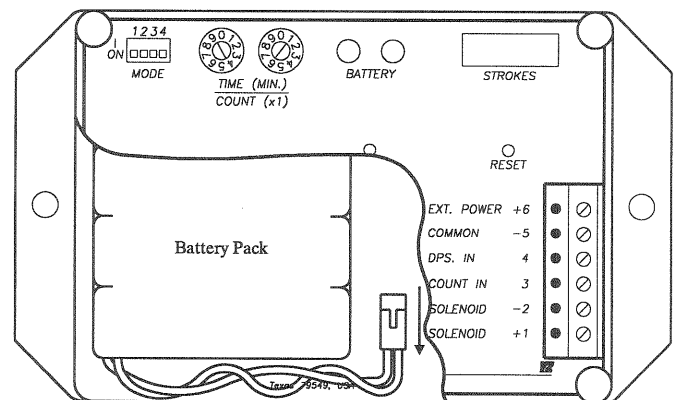
### Replacing a Depleted Battery:

1. Remove the four thumb screws and cover plate.
2. The battery is located in the lower left hand corner of the Z-65/6 controller assembly.
3. Unclip the battery plug from the battery receptacle.
4. Replace the depleted battery with a fresh battery pack (part No. E3-2001).

*NOTE: follow the illustration to assure proper battery wire placement in the Z-65/6 enclosure.*

5. Return the mode switches to their original positions.

6. Send your depleted battery to:  
YZ Industries Inc.  
206 Lubbock Hwy.  
Snyder, TX 79549 USA



#### 11.4 Recommended spare parts for the DynaPak 3000 Series gas samplers.

Part Number	Description	Qty.	Location
C4-0004	filterelement	1	see diagrams #3 and #4
D3-0115	DP-3000 pump seal kit	1	see diagrams #1 and #2
D3-0116	YZ filter regulator repair kit	1	see diagrams #3 and #4
D3-0142	Z-65/200 fuse replacement kit	1	see diagram #5
E3-2001	battery pack	1	see diagram #5

# 12. Troubleshooting: Timer Mode

## 11.1 Mechanical Operation Test:

A. Set the mode switches as follows:

1. Positions 1, 2 and 3 on.

B. Set the time switches to 00 to enter the diagnostic mode. This mode enables the user to increase the solenoid output rate to one pulse every two seconds.

## 12.2 DPS-2/SPS Test

A. Set the mode switches as follows:

1. Positions 1 and 2 on, 3 and 4 off.

B. Set the time dials to 00 to enter the diagnostic mode.

C. This mode enables the operator to determine if the DPS or SPS is operating properly. This is accomplished by depressing and holding the test switch. If the DPS or SPS is sensing flow in the pipeline, the green LED should illuminate. If flow is not present, the red LED should illuminate.

## 12.3 LCD Stroke Indicator Test Mode:

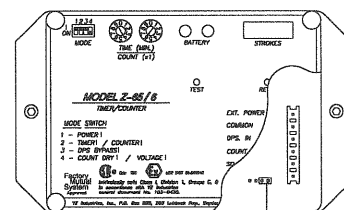
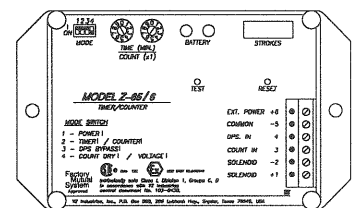
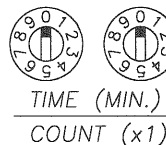
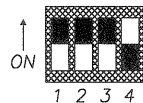
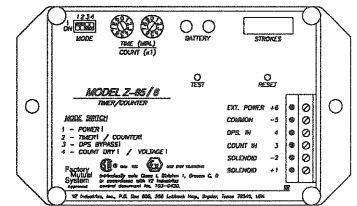
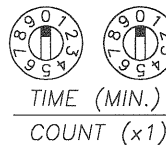
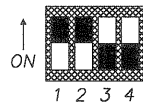
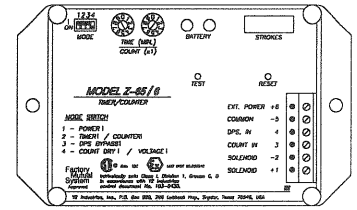
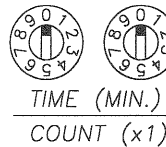
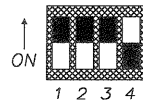
A. To test the stroke counter, set the mode switches as follows:

1. Positions 1, 2 and 3 on.

B. Set the time switches to 00.

C. Unscrew the thumbscrews and remove the six position terminal strip and cover. This will expose the battery pack and the three position configuration jumper (located in the lower right corner of the Z-65/6 controller assembly).

D. Set the configuration jumper to the far right position marked stroke indicator test.



12.3 d - Jumper switch location



E. This will cause all six digits to become active on the stroke counter. Depress the reset. The stroke counter should increment 000000, 111111, etc., up to 999999 each time the solenoid fires. When the counter display reads 999999, the test is complete.

*Note: when the test is complete, move the jumper back to the factory position (far left position).*

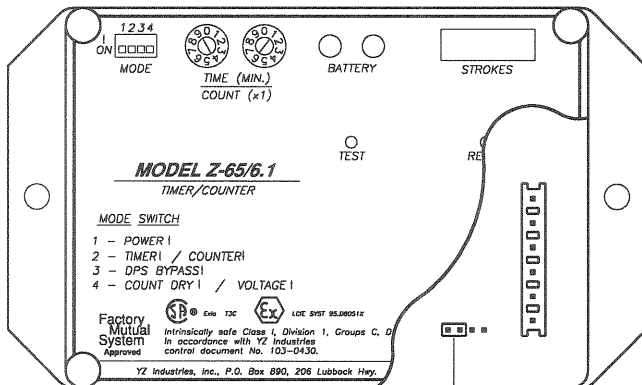
### 12.4 Timer Range Setting

A. there are two Z-65/6 models: the Z-65/6.1 and Z-65/6.03. Each Z-65/6 timer has two ranges for the timer setting dials.

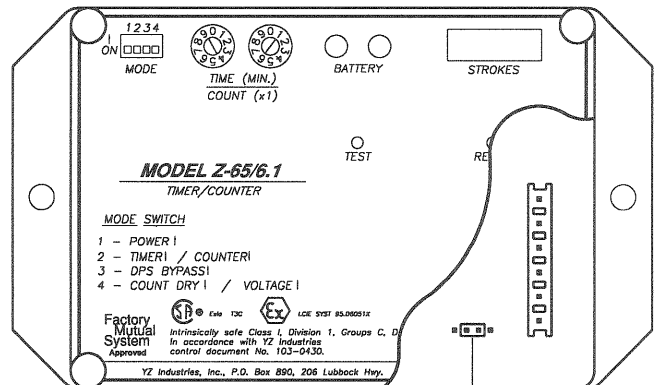
#### 1. Z-65/6.1 Range Setting:

- a. xx minutes: set the configuration jumper to the far left position (factory setting).
- b. x.x minutes: set the configuration jumper to the center position.

*Note: to obtain maximum battery life, choose the longest solenoid stroke rate possible.*



Jumper switch location for 1 - 99 minutes (xx) factory positioned

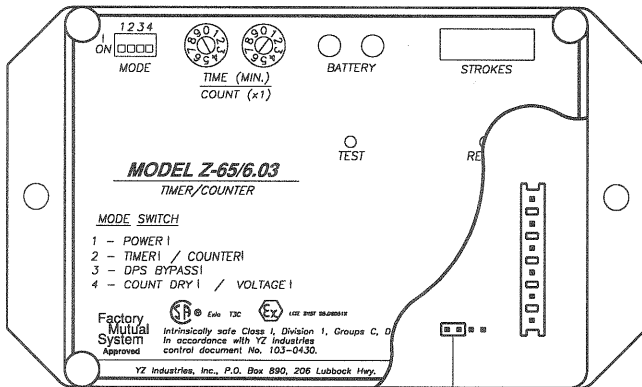


Jumper switch location for .1 - 9.9 minutes (x.x)

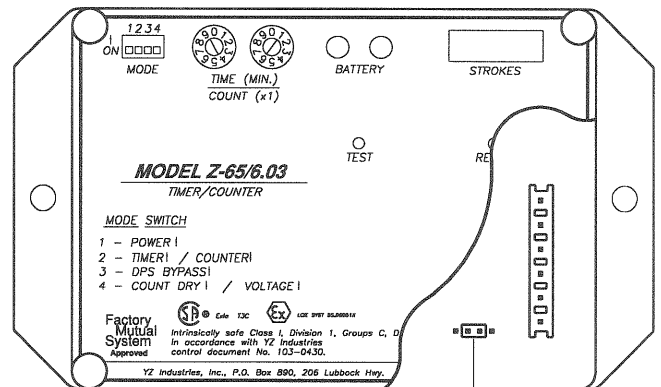
2. Z-65/6.03 Range Setting:

- a. x.x minutes: set the configuration jumper to the far left position (factory setting).
- b. .xx minutes: set the configuration jumper to the center position.

*Note: to obtain maximum battery life, choose the longest solenoid stroke rate possible.*



Jumper switch location for .1 - 9.9 minutes (x.x) factory positioned



Jumper switch location for .03 - .99 minutes (.xx)

# Trouble Shooting: Counter Mode

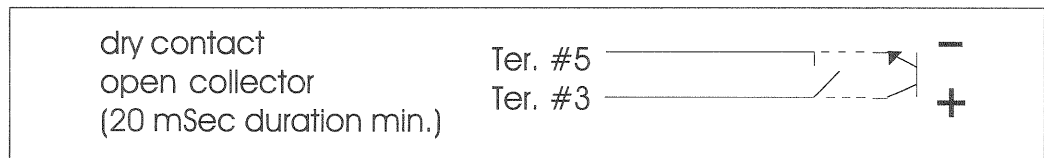
## 12.5 Input Pulse Test

A. Set the mode switches as follows:

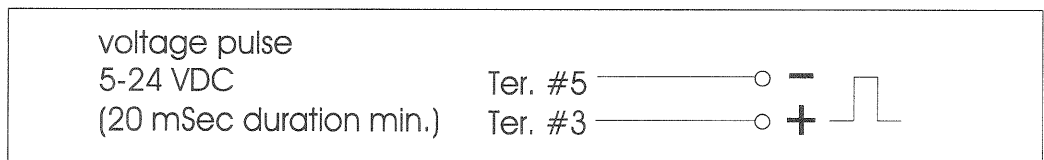
1. Position 1 and 3 on, 2 and 4 off.

B. Set the count switches to 00 to enter the diagnostic mode. This mode enables the user to determine if the proper input pulses are being received at the count input (ter. #3).

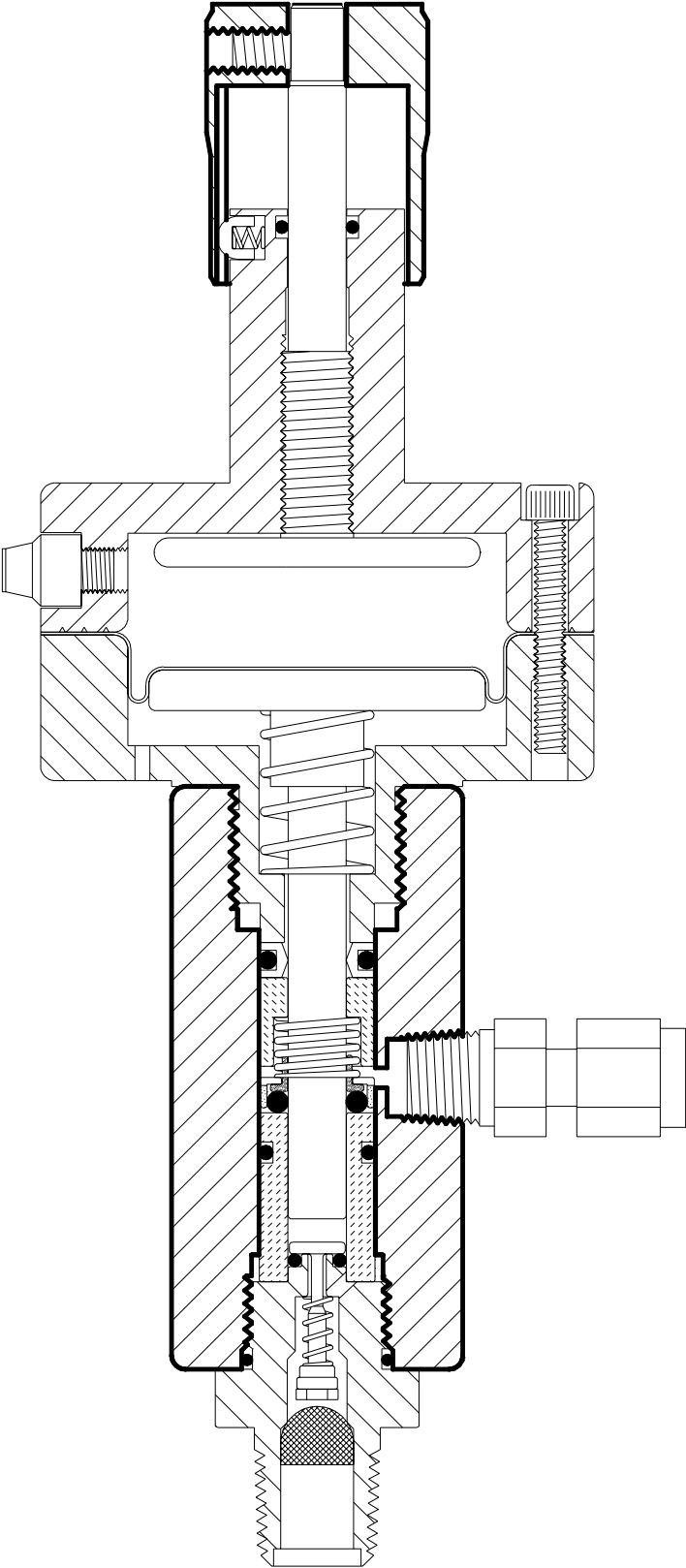
**1. Dry Contact Input:** mode switch 4 should be in the off position. Depress the test switch and hold. A red LED should illuminate. When the dry contact input is received at the counter input (ter. #3) the green LED will turn on and off and the red LED will illuminate again. This will normally occur very quickly and give the appearance that the green LED blinks on when the pulse input is received and removed.



**2. Voltage Pulse Input:** move mode switch 4 to the on position. Depress the test switch and hold. A green LED should illuminate. When the voltage pulse input is received at the count input (ter. #3) the red LED will turn on and off and the green LED will illuminate again. This will normally occur very quickly and give the appearance that the red LED blinks on when the pulse input is received and removed.

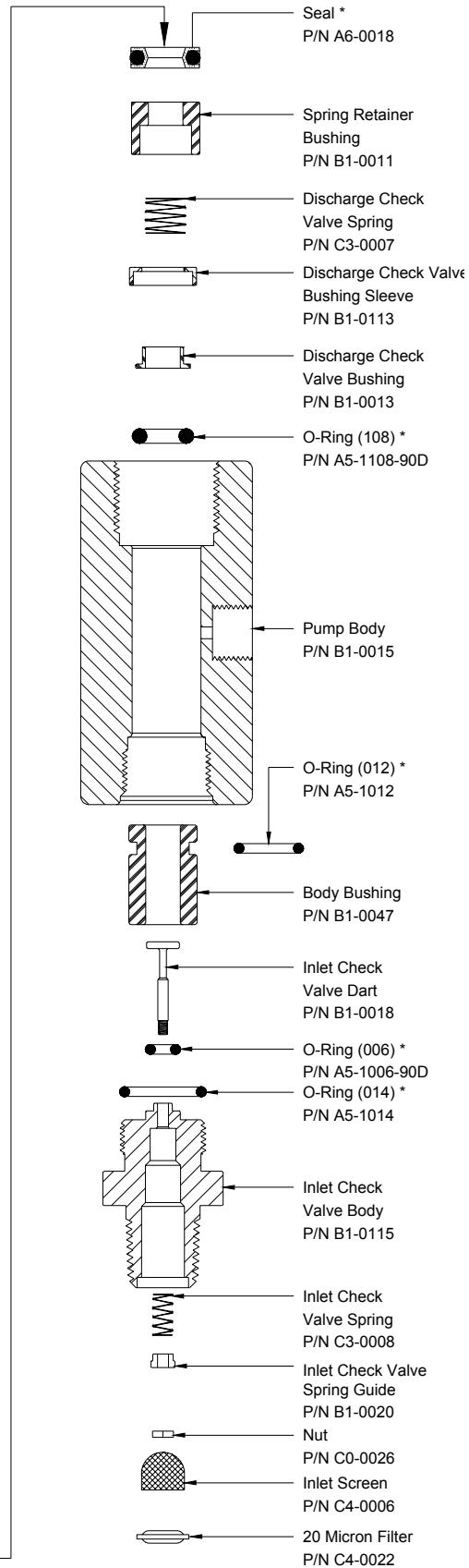
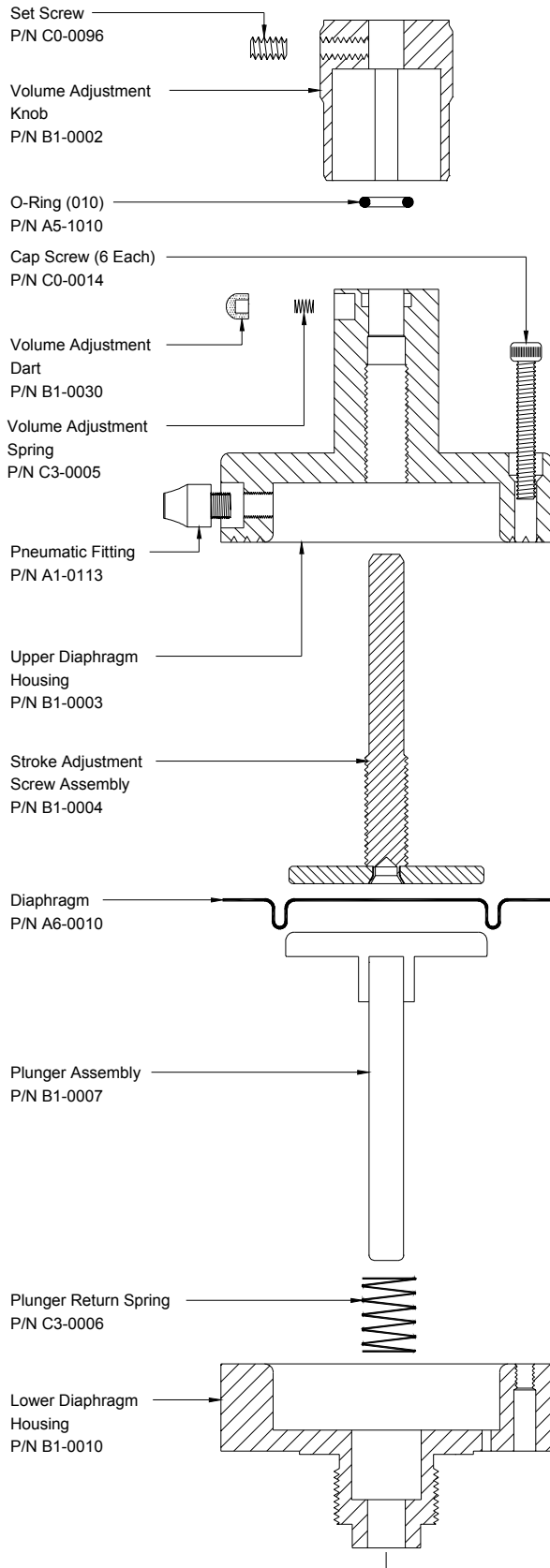


**Diagram #1**  
**DP 3000 pump (assembled)**



# Diagram #2

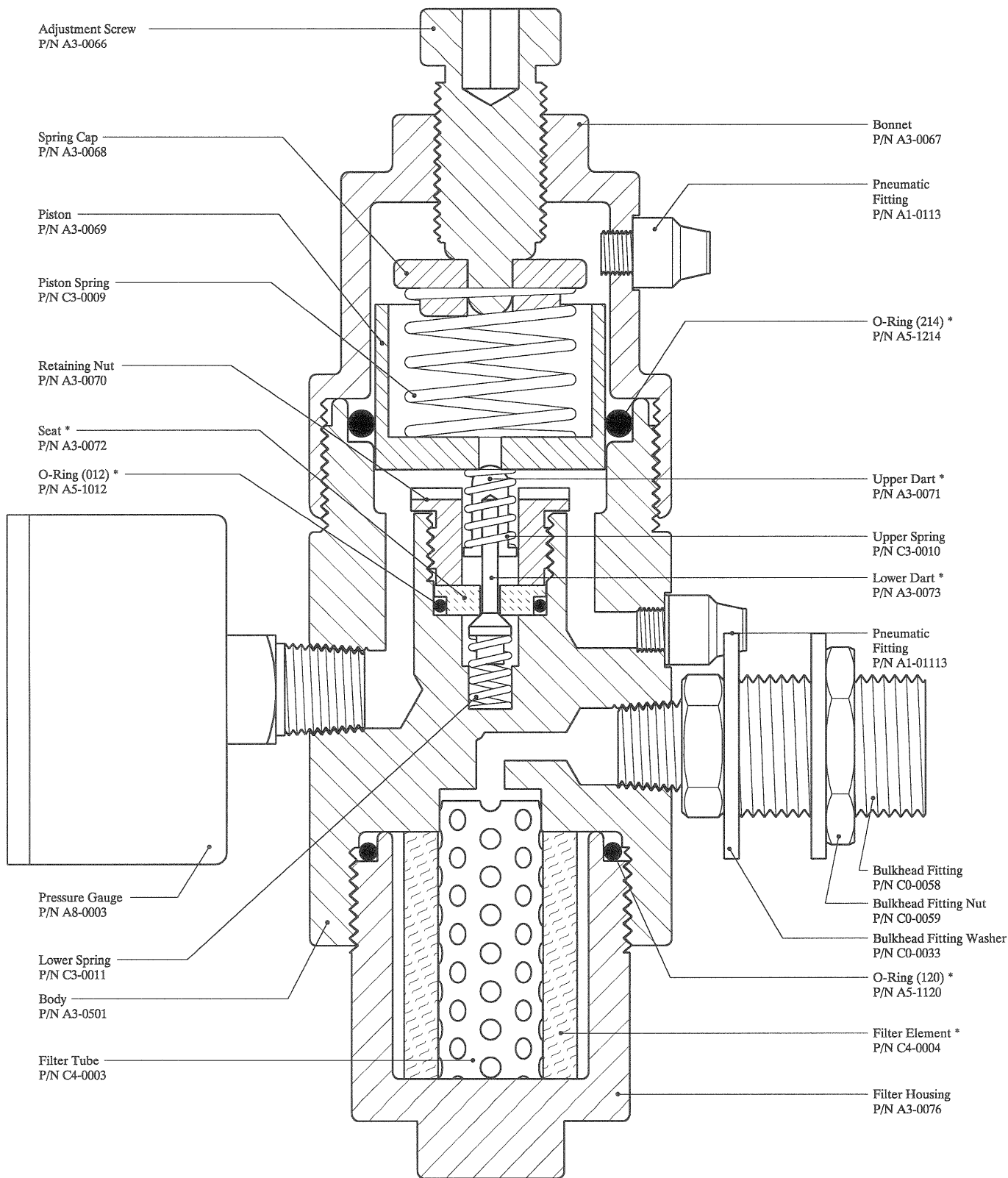
## DP 3000 pump (exploded)



\* DynaPak 3000 Pump Seal Kit P/N D3-0115

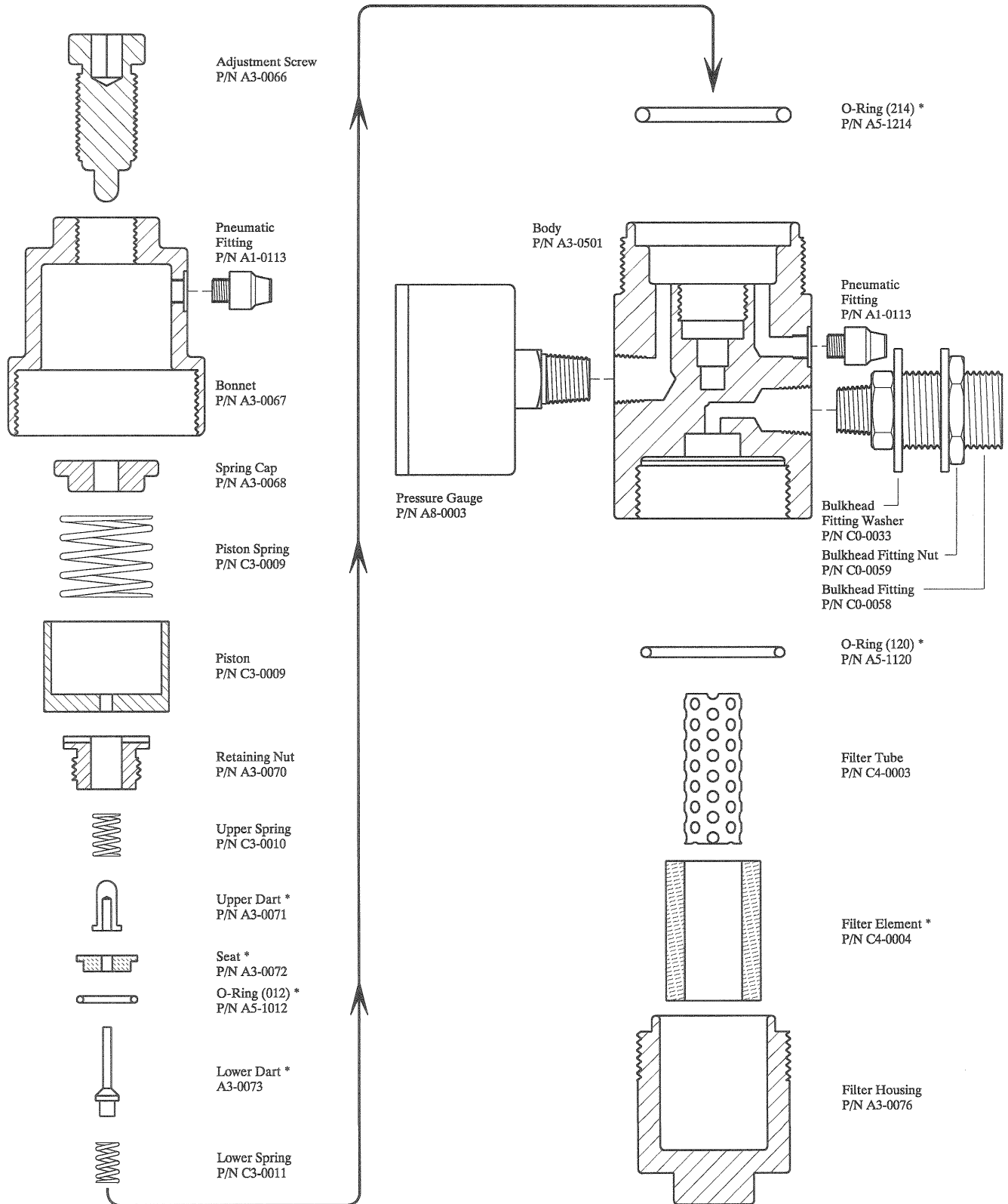


# Diagram #3: YZ external actuation filter/regulator (assembled)



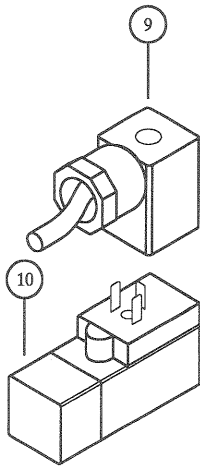
\* Filter/Regulator Repair Kit P/N D3-0116

# Diagram #4: YZ external actuation filter/regulator (exploded)

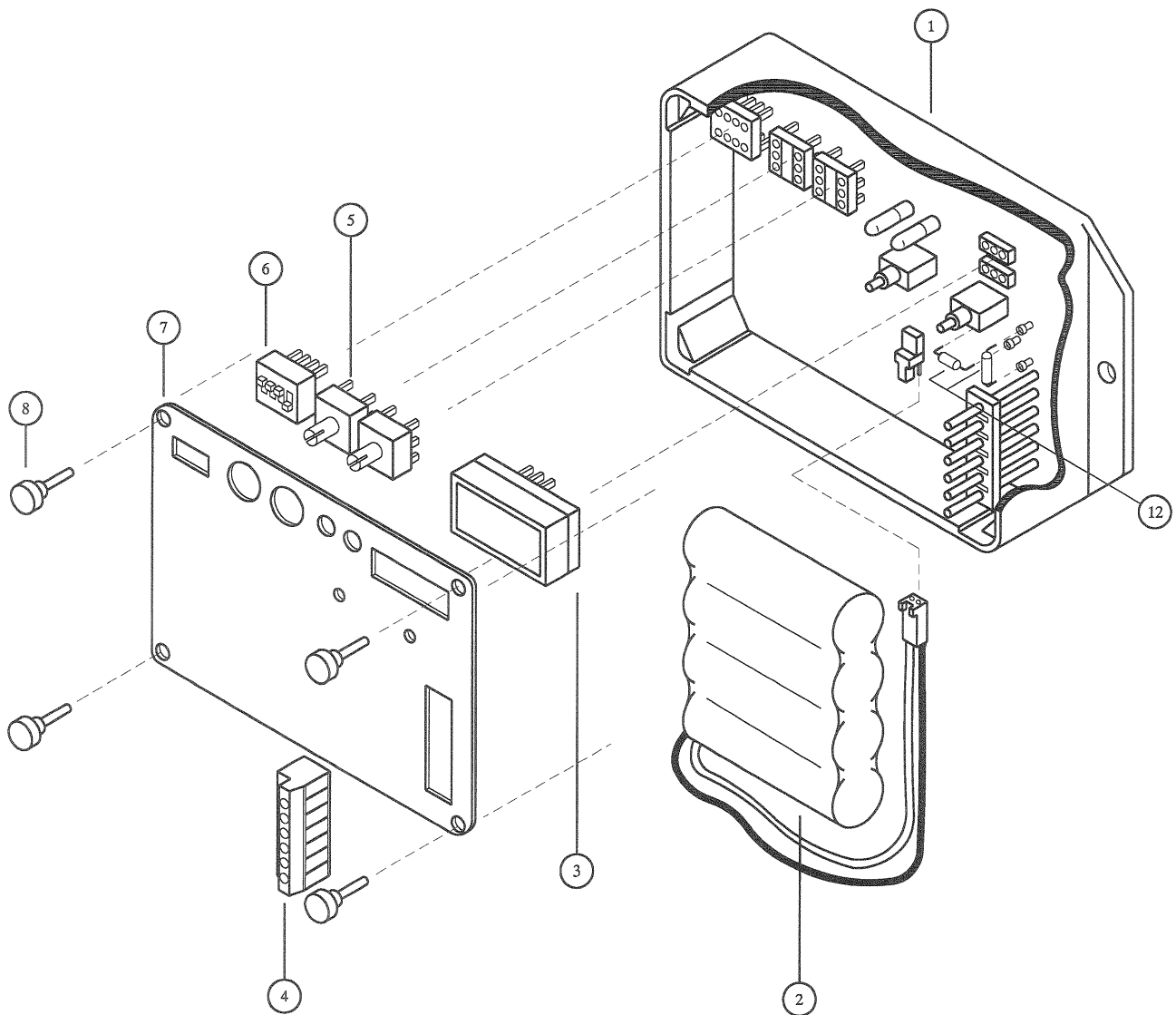


\* Filter/Regulator Repair Kit P/N D3-0116

# Diagram #5: Z-65/6 Controller

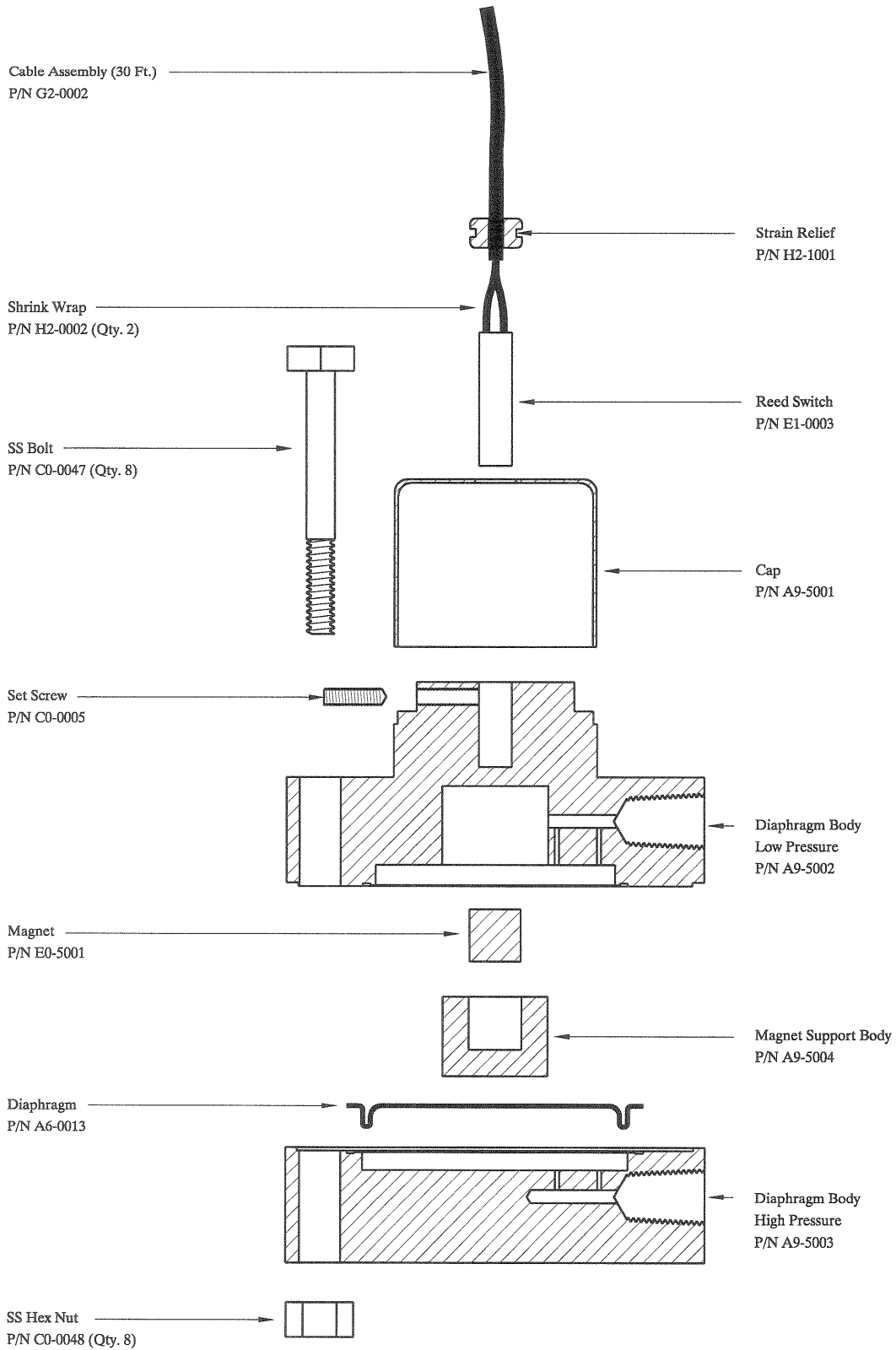


Ref. No.	Description	Part No.	Qty.
1	Z-65/6 Controller Assembly Model Z-65/6.1	F2-0001	1
	Model Z-65/6.03	F2-0018	
2	Battery Pack	E3-2001	1
3*	Stroke Counter Assembly	G1-0001	1
4*	Terminal Strip, 6 Position	H1-0001	1
5*	BCD Switch	E1-0001	2
6*	Mode Switch	E1-0002	1
7	Face Plate Model Z-65/6.1	A9-3001	
	Model Z-65/6.03	A9-3029	
8	Thumb Screw	A9-1001	4
9	Cable Assembly	G2-0001	1
10	Solenoid Valve	A4-0001	1
11	Repair Kit*	D3-0005	1
12	Z-65/200 Fuse Replacement Kit (2 Fuses Per Kit)	D3-0142	1





# Diagram #6: DPS-2



## Diagram #7: DuraSite Portable Sample Vessel Instructions

**Purpose:** The DuraSite Portable Sample Vessel permits the user to remove a liquid or gas hydrocarbon sample from a pipeline or a sampling device. This is accomplished without changing the pressure of the product or exposing it to a contaminant fluid. If properly used and maintained the DuraSite will provide many years of safe, accurate and clean sampling.

**Use:** The DuraSite is a very safe device to use. As with any equipment dealing with flammable products, it is mandatory that a good, thorough operator training procedure be established prior to use.

Typical use of the cylinder would be as follows:

**Step 1: (In The Lab)** Connect a regulated inert gas supply to the pre-charge valve. The product valve should be open. By carefully controlling the pre-charge valve and the regulator, the cylinder can be slowly charged with pre-charge gas (NOTE: This should be done slowly to prevent slamming the piston down to the opposite end). The pressure on the pre-charge pressure gauge should be brought to a reading of 10-50 psi above the expected pressure of the product in the field. Close the pre-charge valve and disconnect the gas supply. Check the pre-charge valve, relief device, and the pre-charge pressure gauge for leaks. Any leaks should be stopped before continuing. The vessel should be placed in a padded carrying case and made ready for field use.

### **USE STEP 2 FOR COLLECTION OF SAMPLE VIA SPOT SAMPLE OR FROM COMPOSITE ACCUMULATOR VESSEL.**

**Step 2a:** Connect the pre-charged sample vessel to the product supply (NOTE: the pre-charge pressure gauge reading should be greater than the product supply pressure reading. If not, repeat Step 1 above).

**Step 2b:** Once the vessel is connected to the product supply, it is necessary to vent a small amount of product prior to filling the vessel. This assures fresh product and removes any air or gas when dealing with liquids. This can be done by loosening the product purge valve a very small amount until the product is purged. After thorough purging, the product purge valve should be tightened.

**Step 2c:** The product pressure gauge reading should be 10-50 psi below the pre-charge pressure gauge reading. By carefully opening the pre-charge valve, the pressure becomes equalized. The pre-charge valve should be carefully controlled so as to not vent the pre-charge gas too fast. The pre-charge port should then be connected to a pipeline connection or relief valve, which will allow movement of the piston while maintaining pre-charge on the cylinder.

**Step 2d:** When the cylinder becomes a maximum of 80% full (see volume indicator), all valves should be closed. The product connection is slowly broken in order to vent any trapped product. After vessel removal, all connections should be checked for leaks and the pre-charge and product valve ports capped to prevent leakage.

**Step 2e:** The vessel should be labeled and placed back into the padded case and made ready for shipment.

### **USE STEP 3 FOR DIRECT CONNECTION TO SAMPLER.**

**Step 3a:** Connect the sample discharge port to the sampler to the product inlet port to the DuraSite using 1/8" stainless steel tubing.

**Step 3b: (Gas sampling)** Connect the pre-charge port to the DuraSite to the pipeline for pre-charge pressure, or configured like the liquid sample application below. (Proceed to step 3d)

**Step 3c: (Light sampling)** Pre-charge the DuraSite as indicated in Step 1, then install a pressure relief valve to the pre-charge port and open the pre-charge valve on the DuraSite. (The pressure relief valve should have a relief pressure setting of approximately 100 psi above line pressure.)

**Step 3d:** Open the product inlet valve of the DuraSite and the purge valve on the sampler. Next open the purge valve on the product end of the DuraSite and allow product to purge all lines and connections out.

**Step 3e:** Close purge valve and begin sample cycle.

**Step 3f:** At the end of sample cycle, close product inlet valve on the DuraSite and remove the DuraSite. Pack the DuraSite in appropriate carrying case to meet D.O.T. guideline, with D.O.T. paperwork and transport to lab for analysis.

**Step 4: (In The Lab)** Prior to analysis, the product should be mixed. This is accomplished simply and efficiently by inverting the cylinder end-over-end, causing the mixing ball to fall through the product. Approximately 10-12 trips of the mixing ball through the product assures a homogenous solution.

**Step 5:** The regulated pre-charge gas should be reconnected to the pre-charge side of the cylinder. The pre-charge gas supply should remain open during analysis.

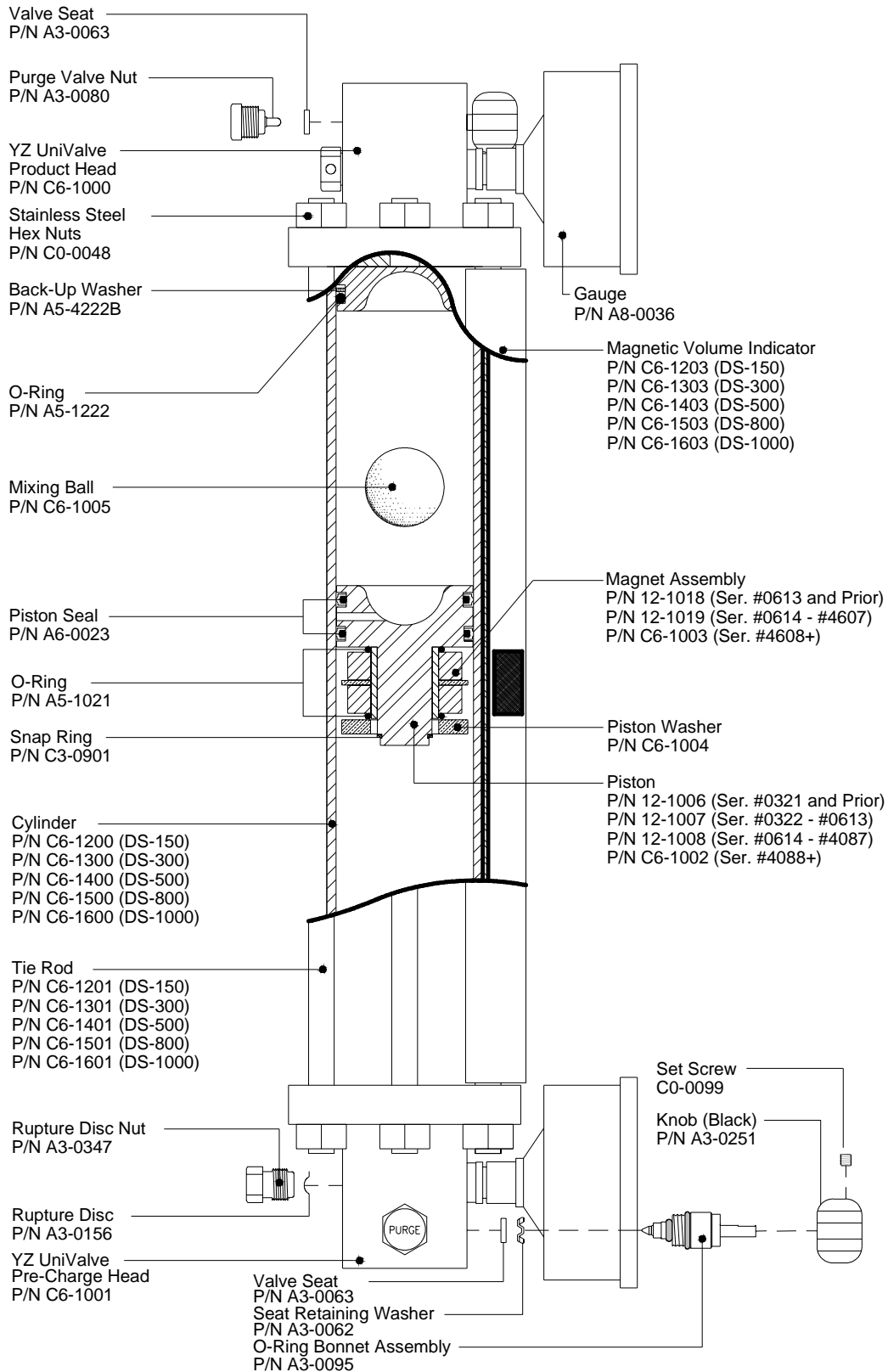
**Step 6:** Purging a small amount of product from the vessel removes unmixed product from the tee, relief device, gauge, etc. The unit can now be connected to a chromatograph and the product analyzed.

**Step 7:** After analyzing, the remainder of the product should be dumped and the vessel properly cleaned. Normal cleaning can be accomplished by rinsing the product end with a petroleum solvent and flushing with acetone. If a more thorough cleaning is required, the vessel should be disassembled.

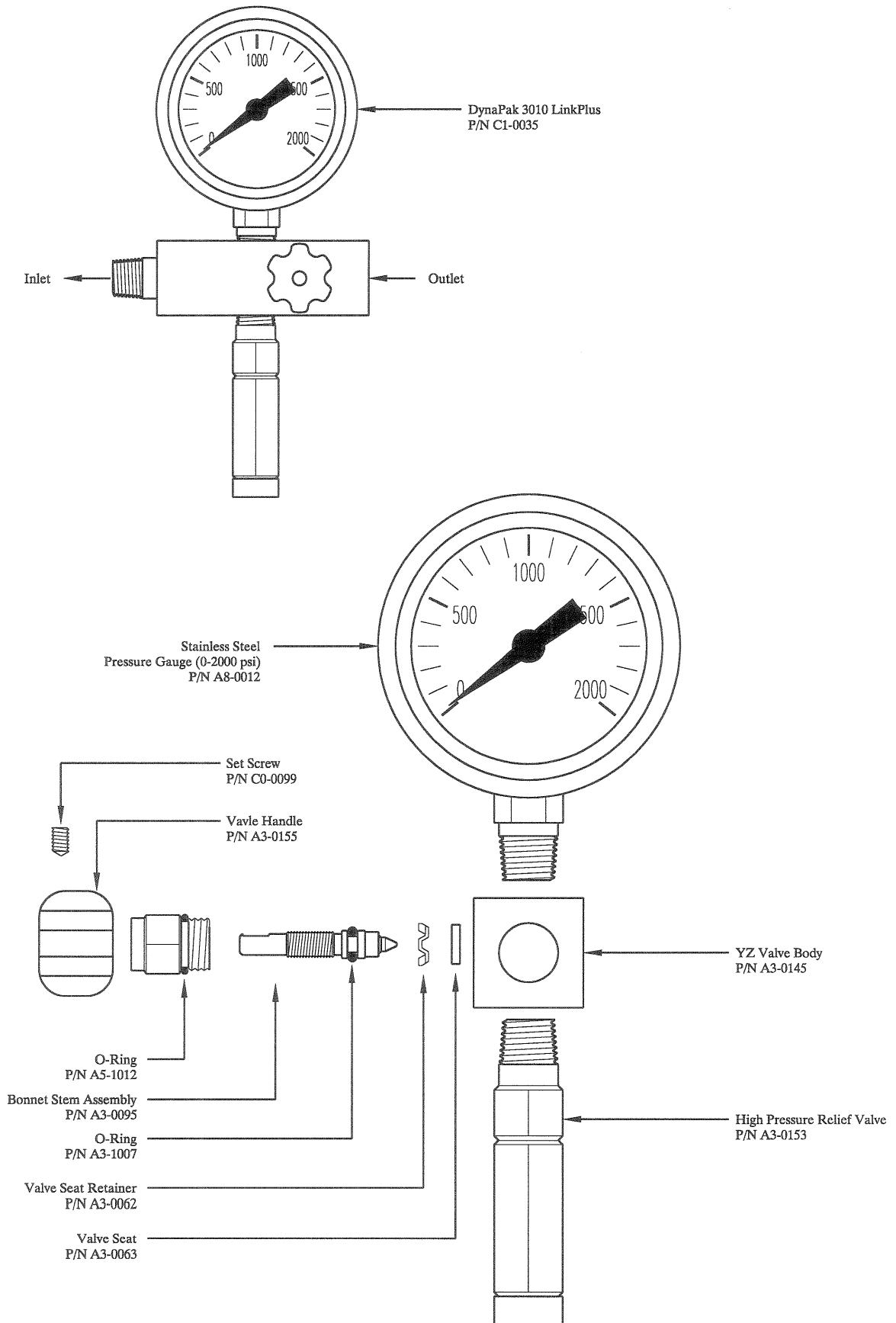
**WARNING:** *A portable sample vessel should never be filled to more than 80%. This allows a 20% pre-charge cushion to absorb thermal expansion of the product.*

**Shipping:** Extreme care should be taken when preparing a vessel for shipment. Both valves should be capped to prevent possible leakage. The vessel should be placed in a snug-fitting, well-padded and durable case. All applicable DOT regulations should be adhered to.

# Diagram #7: DuraSite (Illustrated)



# Diagram #8: LinkPlus

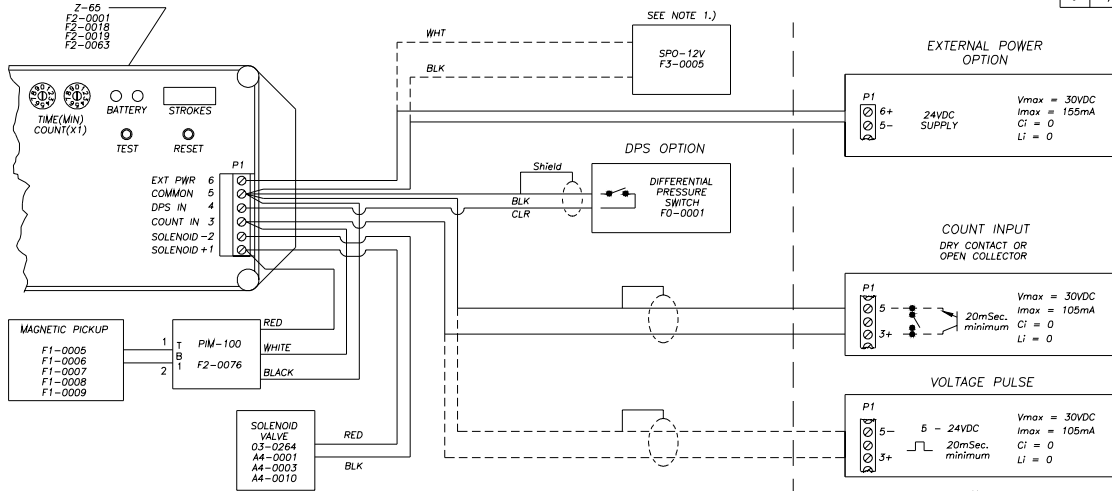


# Diagram #9: Z-65 Installation Notes/Wiring Control Documentation

## System Installation Notes and Recommendations

The manufacturer's system installation instructions and the National Electric Code, Canadian Electrical Code where applicable, must be followed when installing this equipment. Tampering or replacement with non-factory components may adversely affect the safe use of the system. Only the specified batteries should be used with this apparatus. For guidance on installation see ANSI/ISA 12.6 Installation of Intrinsically Safe Instrument Systems in Class I Hazardous Locations.

REVISIONS		
REV	DATE	DESCRIPTION
D	5/15/92	
E	10/7/93	
F	2/06/95	
G	3/20/97	
H	7/13/98	ECO-088
J	2/3/04	ECO-259 [REH]



CLASS I, DIVISION 1, GROUP C,D T3C HAZARDOUS AREA EExia IIB ZONE 0 T4

$$V_{MAX} \geq V_{OC}$$

$$I_{MAX} \geq I_{SC}$$

$$C_A \geq C_i + C_{CABLE}$$

$$L_A \geq L_i + L_{CABLE}$$

CONTROL EQUIPMENT SHALL NOT USE OR GENERATE MORE THAN 250VAC

Exia INTRINSICALLY SAFE / SECURITE INTRINSEQUE

Z-65 WIRING DIAGRAM

CERTIFIE CONFORME A L'EXECUTION  
SIGNATURE \_\_\_\_\_ DATE \_\_\_\_\_  
\*\* NO CHANGES ARE TO BE MADE TO THIS DRAWING WITHOUT PRIOR CSA APPROVAL.

 3101 POLLOCK DR., CONROE, TEXAS 77303	DRAWING NO: 103-0430	
	SCALE: 1 OF 1	NTS
DESCRIPTION Z-65 WIRING CONTROL DOCUMENT	SHEET 1 OF 1	B SIZE
THIS DRAWING AND ALL INFORMATION CONTAINED HEREIN REMAINS THE PROPERTY OF YZ SYSTEMS, INC. ALL RIGHTS ARE EXPRESSLY RESERVED AND MAY NOT BE REPRODUCED IN WHOLE OR IN PART WITHOUT YZ SYSTEMS, INC. WRITTEN CONSENT.	DRAWN: <u>SC</u>	DATE: 11-20-91
	CHECKED:	DATE:
	APPROVED:	DATE:

NOTES  
1.) NOT FOR USE IN EExia IIB T4 ZONE 0 AREA.

