

DynaPak Gas Sampler

S Y S T E M S U P P O R T M A N U A L

DP-2010RXNF

DynaPak 2010RXNF System Support Manual

Version 10302001

Table Of Contents

1. Introduction	3
2. System Components	3
3. Theory of Operation	4
4. Sampler Location	5
5. Sampler Installation	6
6. Sample Vessel Installation	8
7. Operational Check & Leak Testing	9
8. Sampler Set-Up: time-based sampling	10
9. Sampler Set-Up: time-based sampling with the DPS-2	12
10. Sampler Set-Up: proportional- to-flow sampling	14
11. Sampler Maintenance	16
12. Trouble Shooting	20
13. Diagrams	
#1 DP-2000 pump (assembled)	24
#2 DP-2000 pump (exploded)	25
#3 YZ filter regulator (assembled)	26
#4 YZ filter regulator (exploded)	27
#5 LinkPlus	28
#6 DPS-2	29
#7 Z-65 controller	30
#8 Z-65 installation notes/wiring control documentation	31
#9 DuraSite Portable Sample vessel installation	32
Notes	34

1. Introduction

Congratulations on your purchase of the DynaPak 2010 Series Sampler. You've made a wise measurement investment for your company.

Before you begin installation, insure that all of the necessary components are present. You will need a sample cylinder(s) during the installation. If you have questions concerning installation/operation, contact your YZ representative or YZ Customer Service at 936.788.5593.

2. System Components

The primary components of the DynaPak 2010 Sampling System are illustrated here.

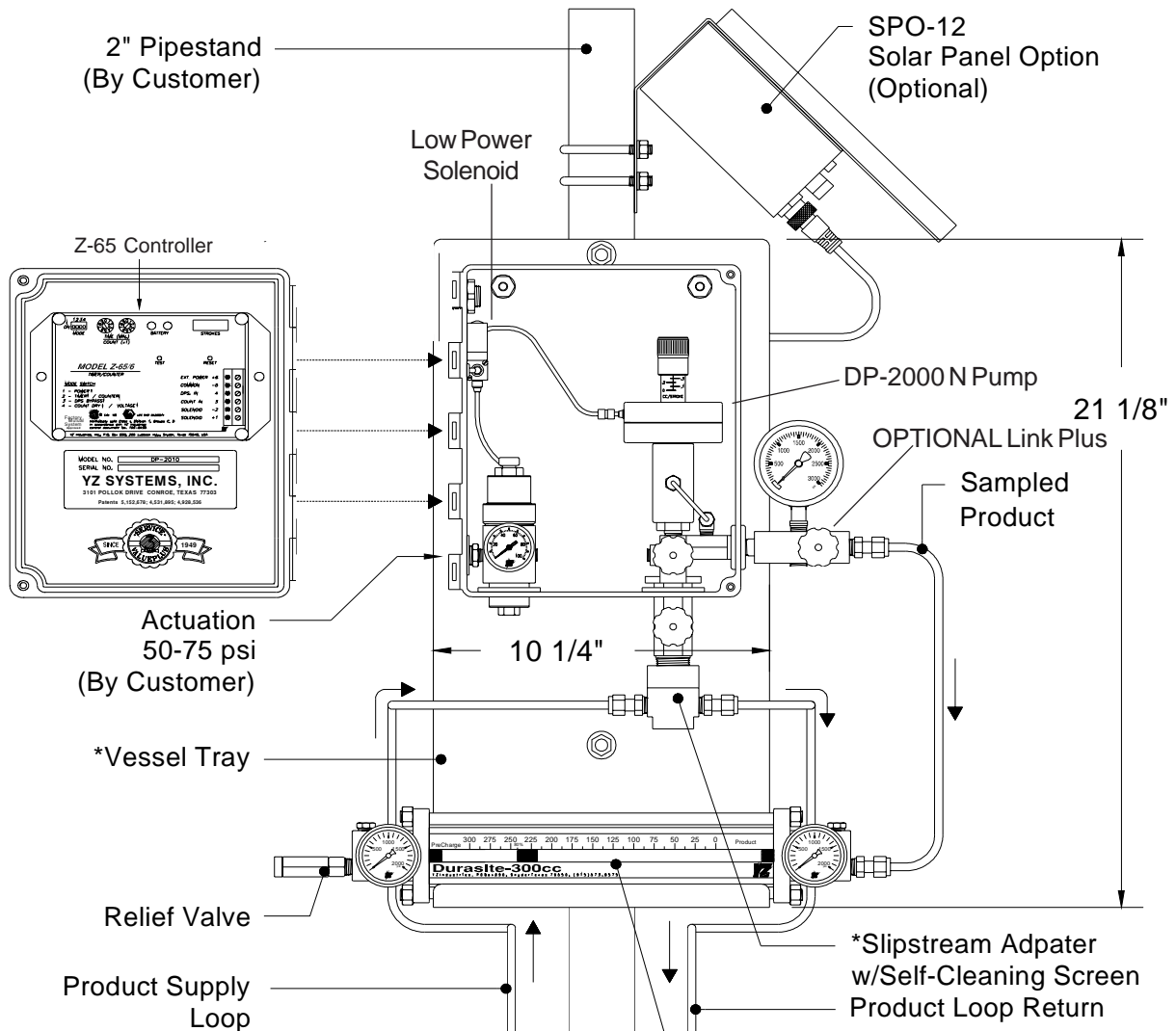

3. Theory of Operation

DynaPak 2010 Gas Sampler

The DynaPak 2010R Sampler is an off the pipeline mounted system which uses the pneumatically operated, positive displacement DynaPak 2000 pump, the Z-65 timer/controller, the YZ filter/regulator and a low power solenoid valve to obtain gas samples. **The 2010 provides three modes of operation:**

A. Time-based sampling - in this mode of operation, the 2010 extracts a gas sample from the pipeline at regular time intervals. The volume of the sample is set by the operator using the volume adjustment feature of the DP-2000 pump. The Z-65 controller operates as a recycling timer, periodically energizing a low power solenoid valve. Energizing the solenoid valve allows actuation gas to stroke the DP-2000 pump. The rate at which this occurs is a function of operator input. Two 10 position switches are used to set the off time interval. The number of times the solenoid output is activated is recorded by the onboard LCD stroke indicator.

B. Time-based sampling with the Optional YZ differential pressure switch (DPS-2) - this mode of operation is similar to the time-based sampling mode, except that the DPS-2 converts a differential pressure signal to an electrical signal that the Z-65 timer uses to determine if flow is present in the pipeline. In effect, the DPS allows the Z-65 timer to shut off when flow stops in the pipeline, and when flow starts again, the ability to start-up and resume operation.

C. Proportional-to-flow sampling - in this mode of operation, the Z-65 counter operates as a dividing counter. The Z-65 counter periodically energizes a low power solenoid valve. As in the other two modes of operation, this allows actuation gas to stroke the DP-2000 pump. The rate at which this occurs is a function of operator input as well as the host computer or other device that inputs pulses per volume metered. The two 10-position switches on the Z-65 are used to set the number of pulses the counter will count before activating the solenoid output. The number of times the solenoid output is activated is recorded by the onboard LCD stroke indicator. Sample volume is again controlled using the DP-2000 volume adjustment knob.

In all three modes of operation, the Z-65 timer/controller operates using a replaceable internal battery pack. The battery pack condition is monitored by way of two indicator LEDs. When the battery pack needs replacement, the red LED will illuminate when the solenoid output is activated. If the battery pack is good, the green LED will illuminate when the solenoid is activated.

The **External Power Option** can be used in lieu of the internal battery pack. The External Power Option (model # EPO-120) consists of an AC to DC convertor and intrinsically safe barrier to convert 120 VAC power to 28 VDC to operate the controller without the use of the internal battery pack.

The **Solar Power Option** would be used in lieu of the internal battery pack. The **Solar Power Option** (model #SPO-12) consists of a 5 watt solar panel with RM-12 charger regulator module and internal 12V, 5 Amp hour battery pack.

4. Sampler Location

4.1 The sampler should be connected to the pipeline using stainless steel tubing and a sample probe. The sample probe should be located a minimum of five pipe diameters from any device which could cause aerosols or significant pressure drops.

4.2 The sampler probe should not be located within the defined meter tube region (AGA 3 manual).

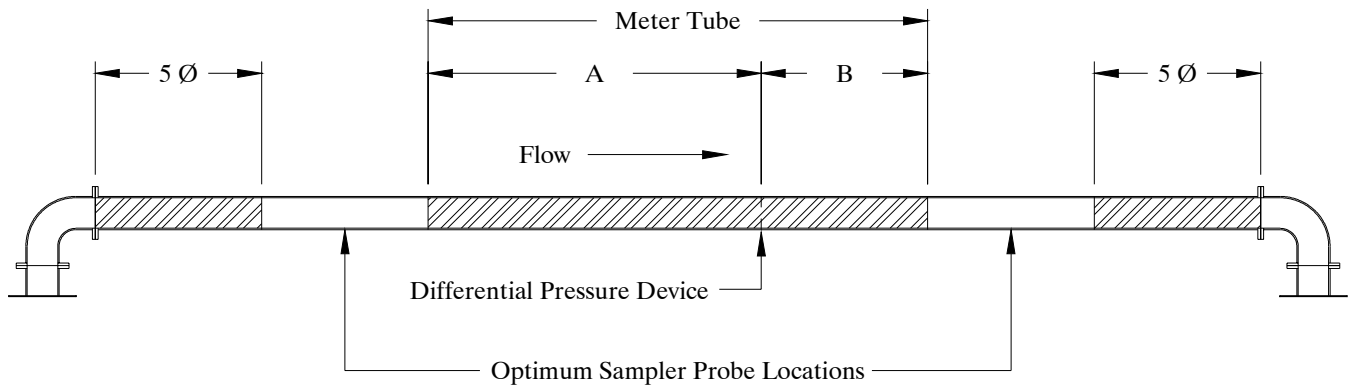

A = The number of unobstructed, straight pipe diameters upstream (see AGA - 3 manual).

B = The number of unobstructed, straight pipe diameters downstream (see AGA - 3 manual).

5. System Installation

5.2 Optional DPS-2

Maximum Pipeline Pressure is 1500 psi, when using this option.

- With the low pressure supply valve and the high pressure supply valve closed, connect the DPS-2 to the orifice connection tubing.
- Open the equalization valve.
- Open the low pressure supply valve or the high pressure supply valve.

NOTE: Do not open either the low pressure supply valve or the high pressure supply valve without ensuring that the equalization valve is open. Failure to do so may damage the DPS-2's internal components.

- Open the other supply valve.
- Close the equalization valve.
- Run the free end of the DPS-2 cable through the cable entry connector located on the upper left side on the DynaPak 2010 enclosure.
- Connect the DPS-2 cable as shown in the diagram.
- Tighten the cable entry connector, allowing for enough cable length to open the enclosure.

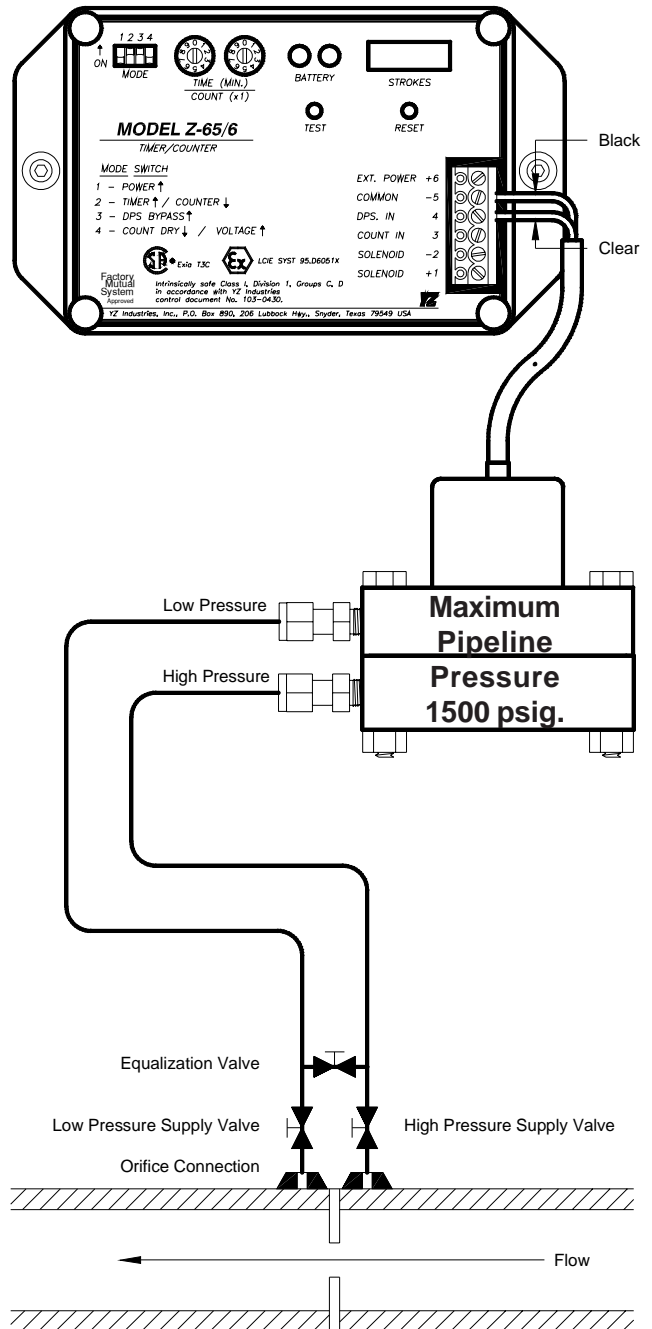

6. Sample Vessel Installation

6.1 Variable pressure/constant volume cylinders.

Spun cylinders may be installed in a horizontal position on the DynaPak BackRack vessel rack. Avoiding traps in the line, install stainless steel tubing and fittings from the sample discharge port of the sampler to the product end of the sample cylinder.

300cc and 500cc spun cylinders may also be installed in a vertical position. Piping from the sampler discharge port to the sample vessel should be arranged so that liquid traps are not created.

6.2 Variable volume/constant pressure cylinder.

*The free-floating piston cylinder (DuraSite) may be installed in a horizontal position on an optional vessel rack. Free-floating piston cylinders should **NOT** be installed on the DynaPak BackRack vessel rack.

Install 1/8" tubing from the sample discharge port of the manifold to the product end of the vessel. Avoid traps in this line.

See diagram #9 for DuraSite portable sample vessel instructions.

6.3 LinkPlus. Install the **optional** LinkPlus directly into the sample discharge port of the sampler. Use stainless steel tubing and fittings to connect the LinkPlus outlet to the product end of the sample cylinder.

****Standard configuration for this option package.***

7. Operational Check & Leak Testing

7.1 When all of the tubing connections have been completed, close the purge valve on the front of the sampler probe body. Open the sample probe supply valve to allow pipeline pressure into the sampler. Check all connections using a liquid leak detector.

7.2 Adjust the filter/regulator from the following ranges:

Pipeline Pressure	Actuation Pressure
Under 700 psig (48 Bar)	50 psig (3.5 Bar)
700-1500 psig (48-103 Bar)	65 psig (4.5 Bar)
1500-2160 psig (103-149 Bar)	75 psig (5.2 Bar)

7.3 Turn the stroke adjustment knob on the top of the pump counterclockwise to set the pump displacement at .4cc/stroke.

7.4 Move all of the mode switches on the Z-65 to their off positions.

7.5 Move both timer/counter dials to the 0 position (00 minutes).

7.6 Move mode switches 1, 2 and 3 to the on position. The pump will begin stroking once every 2 seconds in a diagnostic test mode.

7.7 Allow the sampler to operate until the pipeline pressure **plus** 100 psi (6.9 Bar) is achieved at the sample discharge.

7.8 Return the mode switches to their off positions.

7.9 Check all connections from the sampler discharge to the connection on the sample cylinder using a liquid leak detector.

7.10 If no leaks are found, the pump and tubing should be considered tested and functional.

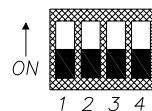
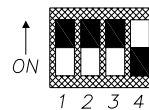
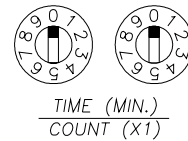
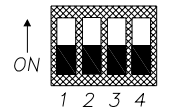
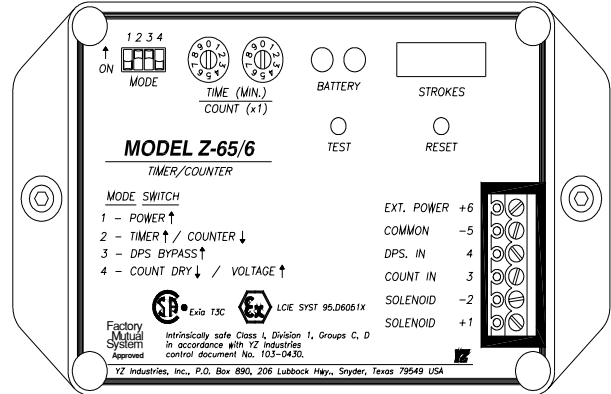

NOTE: Black indicates the switch position.



8. Sampler Set-Up - Time-based sampling

8.1 Calculate the sampling rate using the following 30 day chart:

Number of turns open on pump stroke knob	sample pump displacement per stroke	Sample cylinder volumes			Sample rate (minutes)
		1000 cc	500 cc	300 cc	
3	.100	4	9	15	
6	.200	9	18	30	
9	.300	13	27	45	
12	.400	18	36	60	

8.2 Set the timer dials on the Z-65 to the sample rate from step 8.1.

NOTE: To obtain maximum battery life, choose the longest time interval and the largest pump displacement setting possible.

Example

18 minutes

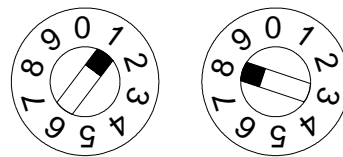

TIME (MIN.)

COUNT (x1)

NOTE: The time (18 minutes) above corresponds to the dial setting shown for the Z65 model with the timer range setting in the factory position (jumper on the two left pins). See section 12.4 Timer Range Setting.

8. Sampler Set-Up - Time-based sampling

8.3 Adjust the pump volume adjustment knob to the value used in the calculations in step 8.1.

Sample pump displacement per stroke	Number of turns open on the pump volume knob
.1cc	3
.2cc	6
.4cc	12

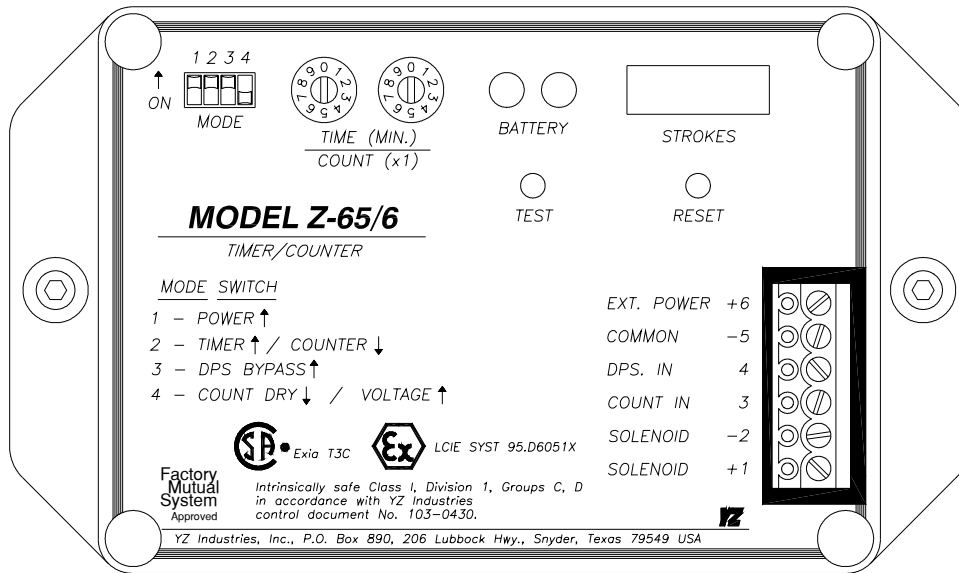

8.4 Turn mode switch 1 to on.

8.5 Turn mode switch 2 to on.

8.6 Turn mode switch 3 to on.

8.7 Turn mode switch 4 to off.

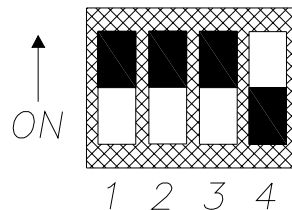

8.8 Press the test button once to initiate the timer sequence.



9. Sampler set-up - Time-based sampling with the Optional DPS-2

9.1 Calculate the sampling rate using the following 30 day chart

Number of turns open on pump stroke knob	sample pump displacement per stroke	Sample cylinder volumes			Sample rate (minutes)
		1000 cc	500 cc	300 cc	
3	.100	4	9	15	
6	.200	9	18	30	
9	.300	13	27	45	
12	.400	18	36	60	

9.2 Set the timer dials on the Z-65 to the determined time from step 9.1.

NOTE: To obtain maximum battery life, choose the longest time interval and the largest pump displacement setting possible.

Example

18 minutes

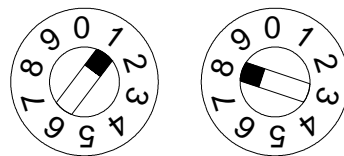

TIME (MIN.)

COUNT (x1)

NOTE: The time (18 minutes) above corresponds to the dial setting shown for the Z65 model with the timer range setting in the factory position (jumper on the two left pins). See section 12.4 Timer Range Setting.

9. Sampler set-up - Time-based sampling with the Optional DPS-2

9.3 Adjust the pump volume adjustment knob to the value used in the calculations in step 9.1.

Sample pump displacement per stroke	Number of turns open on the pump volume knob
.1cc	3
.2cc	6
.4cc	12

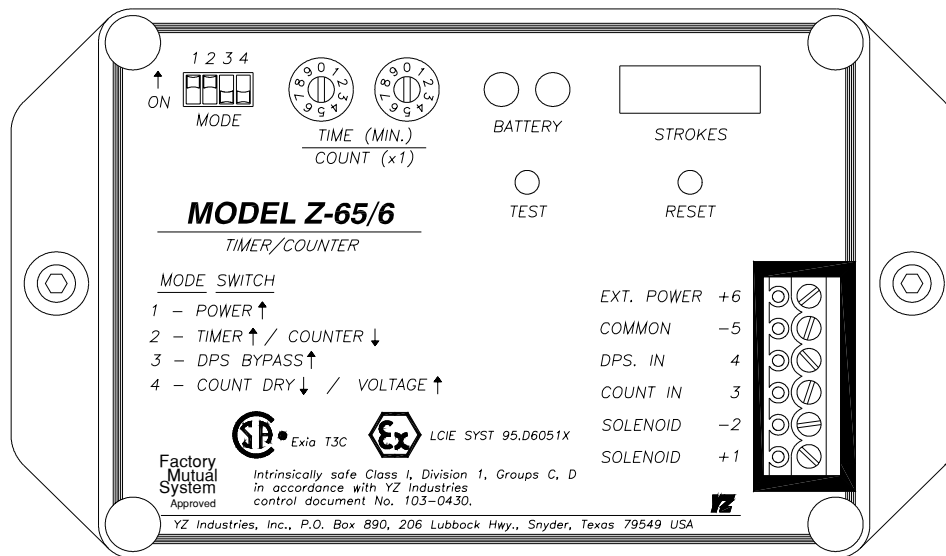

9.4 Turn mode switch 1 to on.

9.5 Turn mode switch 2 to on.

9.6 Turn mode switch 3 to off.

9.7 Turn mode switch 4 to off.

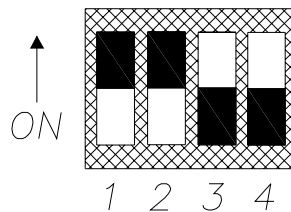

9.8 Press the test button once to initiate the timer sequence.

NOTE: For the Z-65 to operate the DP-2010 System, a minimum pressure differential of 3" of water must exist between the high pressure and low pressure ports of the DPS-2.



10. Sampler set-up - proportional-to-flow sampling

In this mode of operation, the Z-65 controller is used as a dividing counter to control the rate at which the pump is actuated. The desired time between pump strokes is controlled by the host computer or output device that will give an input pulse to the Z-65 controller.

10.1 Determine if the incoming input is either a dry contact or voltage pulse.

10.2 If the input is a dry contact:

a. Terminate the incoming connections to the Z-65 terminal strip (see illustration).

b. Turn mode switch 1 to on.

c. Turn mode switch 2 to off.

d. Turn mode switch 3 to on.

e. Turn mode switch 4 to off.

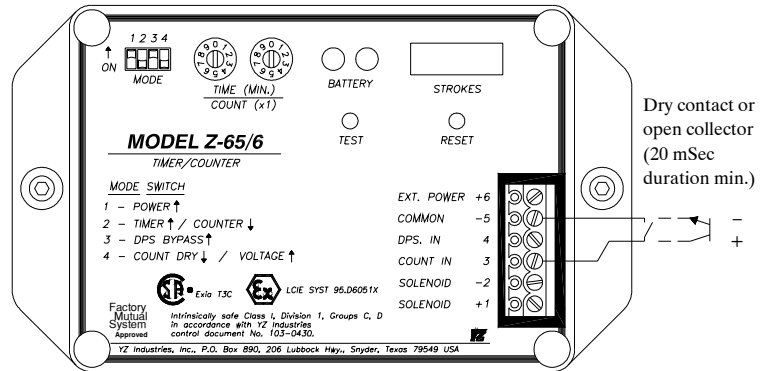
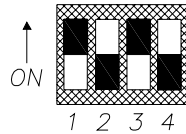

OR

10.3 If the input is a voltage pulse:

a. Terminate the incoming connections to the Z-65 terminal strip (see illustration).

b. Turn mode switch 1 to on.

c. Turn mode switch 2 to off.

d. Turn mode switch 3 to on.

e. Turn mode switch 4 to on.

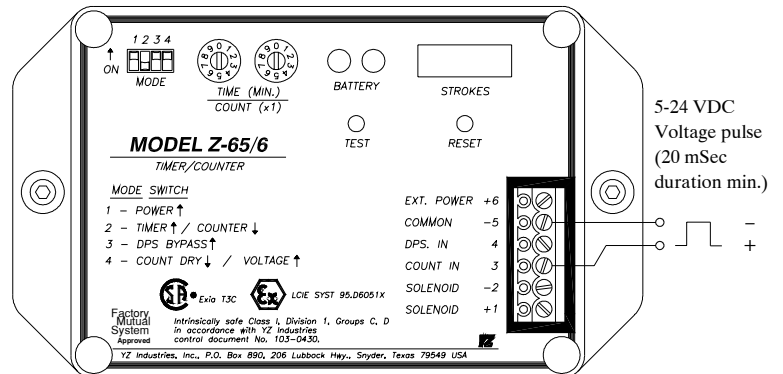
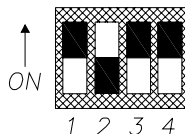

10. Sampler set-up - proportional-to-flow sampling

10.4 Calculate the counter setting using the following chart:

1. your pump displacement (from .1 to .4cc's)	=	a. _____
2. your sample cylinder volume in cc's (300cc, 500cc, etc.)	=	b. _____
3. average flow rate (MMCF per day or MCM per day)	=	c. _____
4. sample period in days	=	d. _____
5. pulses/volume metered (pulses/MMCF or pulses/MCM)	=	e. _____
6. counter setting	=	$\frac{a \times c \times d \times e}{(b)}$

	Example #1: English Gas Flow Units	Example #2: Metric Gas Flow Units
pump displacement	(a.) = .2cc	.2cc
sample cylinder size	(b.) = 300cc	300cc
average flow rate	(c.) = 10 MMCF per day	10MCM/day
sample period	(d.) = 30 days	30 days
pulses per volume metered	(e.) = 100 pulses/MMcf	100 pulses/MCM

Example #1
counter setting = $\frac{.2cc \times 10 \text{ MMcf per day} \times 30 \text{ days} \times 100 \text{ pulses per MMcf}}{300 \text{ cc}} = 20 \text{ pulses}$

Example #2
counter setting = $\frac{.2cc \times 10 \text{ MCM per day} \times 30 \text{ days} \times 100 \text{ pulses per MCM}}{300 \text{ cc}} = 20 \text{ pulses}$

10.5 Adjust the pump volume adjustment knob to the value used in the calculation in step 10.4.

Sample pump displacement per stroke	Number of turns open on the pump volume knob
.1cc	3
.2cc	6
.4cc	12

NOTE: If the calculated counter setting is less than 1 or greater than 99, the pulses per volume metered will need to be adjusted. This can be programmed in most flow meters to the desired rate. If the calculated counter setting is less than 1, increase the pulses per volume metered. If the calculated counter setting is greater than 99, decrease the pulses per volume metered volume.

10.6 Turn the counter dials to the appropriate number of pulses you want to count before the sample pump strokes.

Example: 20 pulses; turn dials to 20.

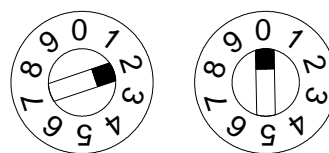

Press the test button once to load the value into the memory.

COUNT (x1)



11. Sampler maintenance

11.1 Recommended preventative maintenance schedule

Every sampling situation is unique. Below are our recommendations for average conditions. A higher BTU content will necessitate more frequent pump/filter maintenance.

- a. Clean and lubricate the sample pump every six months.
- b. Check the filter element every six months, replacing as necessary.
- c. Test the battery every month.
- d. Test the system for leaks each time a fitting or connection has been made.

11.2 Cleaning and lubricating the DP-2000 pump

- a. Close the isolation valves. (Note the isolation valve to the GPA Separator that supplied gas to the Filter Regulator must also be closed)
- b. Disconnect the plastic tubing from the solenoid valve to the pump diaphragm housing by depressing the tubing release sleeve on the diaphragm housing fitting while pulling out the tubing. It is not necessary to remove the fitting from the diaphragm housing.
- c. Remove the sample discharge (1/8" stainless steel tubing) from the pump body.
- d. Screw the stroke adjustment knob all the way down to the 0 cc/stroke setting.
- e. *Unscrew the pump body by hand from the inlet check valve assembly. Separation at this point is recommended to maintain proper tubing location and alignment between the pump body and the probe body. Do not remove the inlet check valve body from the manifold unless cleaning is necessary. To replace the inlet check valve o-ring, carefully cut the o-ring off the head of the dart and stretch the new o-ring over the head of the dart using a light coat of assembly grease.

- f. Remove the diaphragm housing from the pump body by unscrewing the diaphragm housing and carefully pulling the plunger out of the pump body. Inspect the plunger shaft for damage or wear. The diaphragm chamber houses the diaphragm, return spring, stroke adjustment screw and plunger assembly. The diaphragm chamber should not be disassembled unless one of these items needs replacing.

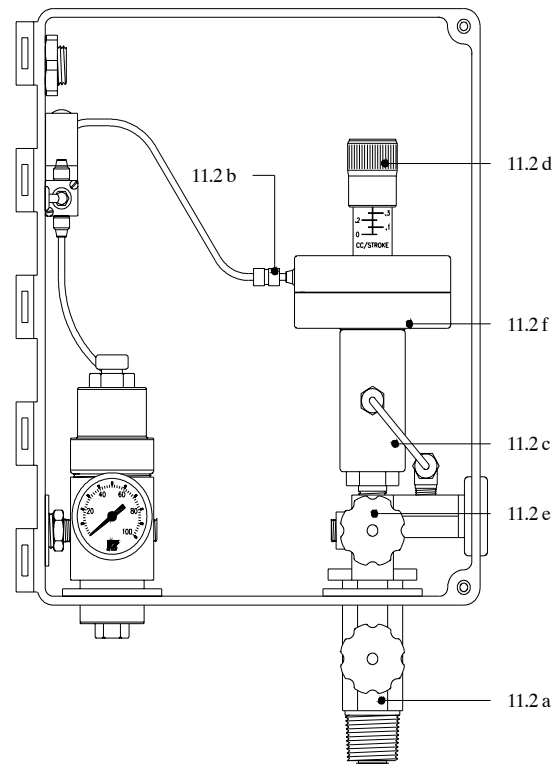

**Screw the stroke adjustment screw all the way down.*

11. Sampler maintenance

g. Remove the internal bushings and o-rings from the pump body by inserting a nonmetallic rod (larger than 1/4", smaller than 1/2") into the top of the pump body. Gently tap to remove all bushings and o-rings out the bottom of the pump body.

h. Clean and inspect all components. Replace if necessary.

NOTE: Normal service generally requires only the replacement of the o-rings and seal. A seal repair kit (part number D3-0002) is available from YZ.

i. Apply a light coat of non-soluble assembly grease on all o-rings and bushings to prevent damage.

j. Install the body bushing into the bottom of the pump body.

NOTE: Apply a light coat of assembly grease on the plunger shaft prior to installation.

k. Insert all other bushings, springs, and o-rings in their respective sequence on the plunger shaft.

l. Carefully install assembly into the top of the pump body, and screw the actuator assembly onto the pump body. (Tighten firmly by Hand ONLY)

m. Install the pump assembly on the inlet valve assembly. (Tighten firmly by Hand ONLY).

n. Connect the 1/8" stainless steel tubing to the pump body and 1/8" plastic tubing to the diaphragm housing.

o. Open the isolation valve.

p. Adjust the stroke adjustment knob to its original setting.

q. Pressure test the pump as previously described for proper operation.

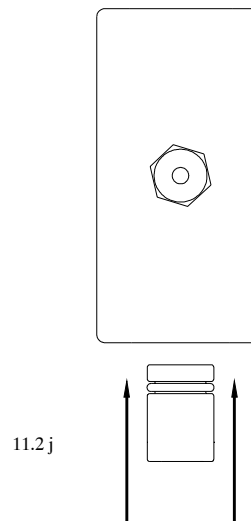
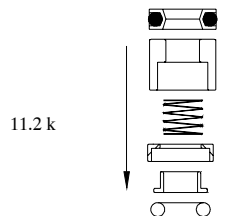
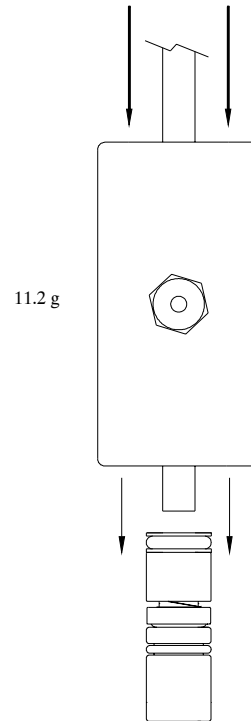

11. Sampler maintenance

11.3 Battery Test

a. Set the mode switches as follows

1. Position 1, 2 and 3 on

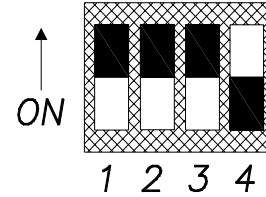

b. Set the time switches to the 01 position.

*NOTE: Time switches must **not** be in 00 position to test the battery.*

This will set the solenoid output rate to one actuation every one minute (based on the factory set time range for the Z-65 model).

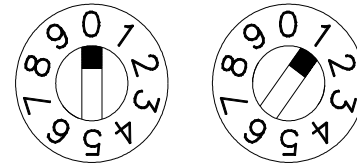

c. Depress the test switch to test the battery. A green LED will illuminate if the battery is good and a red LED will illuminate if the battery is low.

$$\frac{\text{TIME (MIN.)}}{\text{COUNT (x1)}}$$

NOTE

*The solenoid must be connected to test the battery condition. **Battery condition cannot be tested with a volt meter.***

Replacing a Depleted Battery

1. Remove the four thumb screws, cover plate and orange terminal connector.

2. The battery is located in the lower left hand corner of the Z-65 controller assembly.

3. Unclip the battery plug from the battery receptacle.

4. Replace the depleted battery with a fresh battery pack (part No. E3-2001).

NOTE: Follow the illustration to assure proper battery wire placement in the Z-65 enclosure.

5. Return the mode switches to their original positions.

6. Send your depleted battery to:

YZ Systems, Inc.
206 Lubbock Hwy.
Snyder, TX 79549 USA

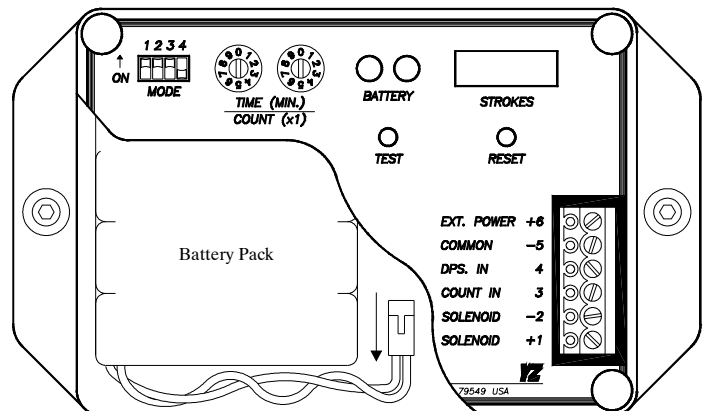

11. Sampler maintenance

11.4 Recommended spare parts for the DynaPak 2000 Series gas samplers

<u>Part Number</u>	<u>Description</u>	<u>Qty.</u>	<u>Location</u>
C4-0004	Filter element	1	see diagrams #3 and #4
D3-0002	DP-2000 pump seal kit	1	see diagrams #1 and #2
D3-0003	YZ filter regulator repair kit	1	see diagrams #3 and #4
D3-0142	Z-65/200 fuse replacement kit	1	see diagram #7
E3-2001	Battery pack	1	see diagram #7



12. Troubleshooting - Timer Mode

12.1 Mechanical Operation Test

- A. Set the mode switches as follows:
1. Positions 1, 2 and 3 on.
 2. Position 4 off.

- B. Set the time switches to 00 to enter the diagnostic mode. This mode enables the user to increase the solenoid output rate to one pulse every two seconds.

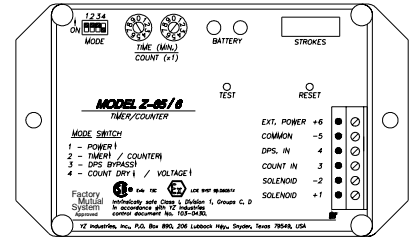
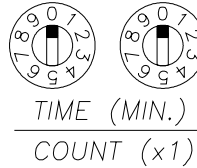
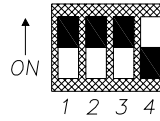

Mechanical Operation Test

12.2 DPS-2 Test

- A. Set the mode switches as follows:
1. Position 1 and 2 on.
 2. Position 3 and 4 off.

- B. Set the time dials to 00 to enter the diagnostic mode.

- C. This mode enables the operator to determine if the DPS is operating properly. This is accomplished by depressing and holding the test switch. If the DPS is sensing flow in the pipeline, the green LED should illuminate. If flow is not present, the red LED should illuminate.

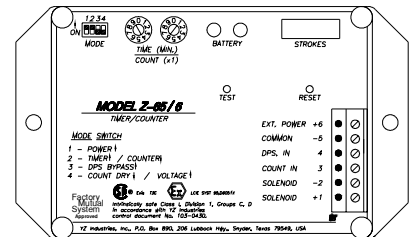
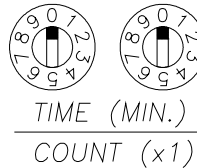
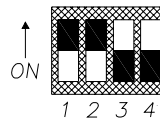

DPS-2 Test

12.3 LCD Stroke Indicator Test Mode

- A. To test the stroke counter, set the mode switches as follows:
1. Positions 1, 2 and 3 on.
 2. Position 4 off.

- B. Set the time switches to 00.

- C. Unscrew the thumbscrews and remove the six position terminal strip and cover. This will expose the battery pack and the three position configuration jumper (located in the lower right corner of the Z-65 controller assembly).

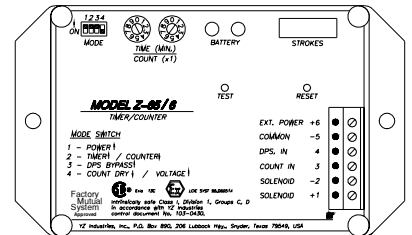
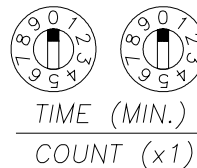
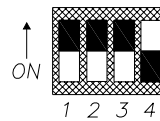

- D. Set the configuration jumper to the far right position marked stroke indicator test.

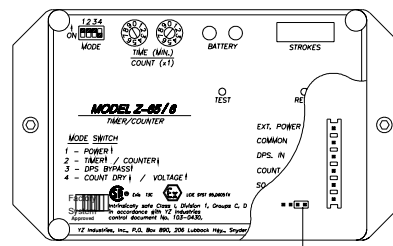

12.3 d - Jumper switch location

12. Troubleshooting - Timer Mode

E. This will cause all six digits to become active on the stroke counter. Depress the reset. The stroke counter should increment 000000, 111111, etc., up to 999999 each time the solenoid fires. When the counter display reads 999999, the test is complete.

Note: When the test is complete, move the jumper back to the factory position (far left position).

12.4 Timer Range Setting

A. There are two Z-65 models: the Z-65/6.1 and Z-65/6.03. Each Z-65 timer has two ranges for the timer setting dials.

1. Z-65/6.1 Range Setting:

- a. xx minutes: set the configuration jumper to the far left position (factory setting).
- b. x.x minutes: set the configuration jumper to the center position.

Note

To obtain maximum battery life, choose the longest solenoid stroke rate possible.

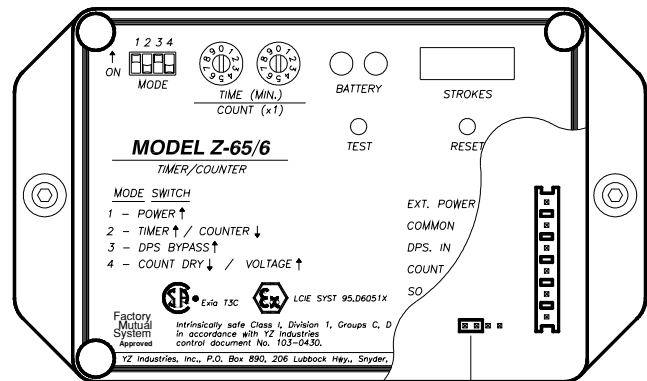

Jumper switch location for 1 - 99 counts (xx) factory positioned

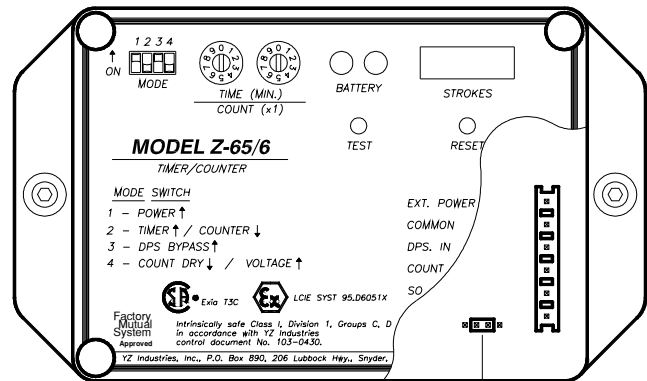

Jumper switch location for .1 - 9.9 counts (x.x)



12. Troubleshooting - Timer Mode

12.4 Timer Range Setting

2. Z-65/6.03 Range Setting:

- a. x.x minutes: set the configuration jumper to the far left position (factory setting).
- b. .xx minutes: set the configuration jumper to the center position.

Note: To obtain maximum battery life, choose the longest solenoid stroke rate possible.

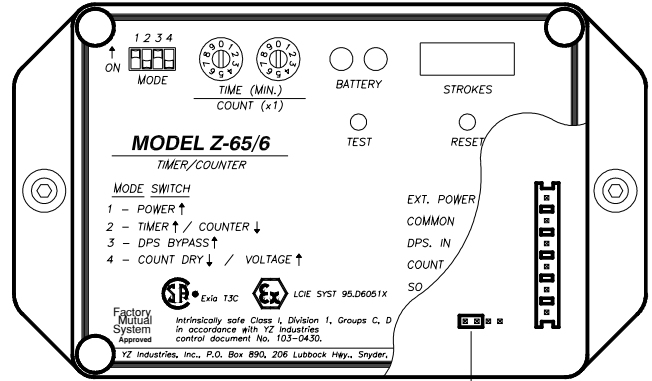

Jumper switch location for .1 - 9.9 counts (x.x) factory positioned

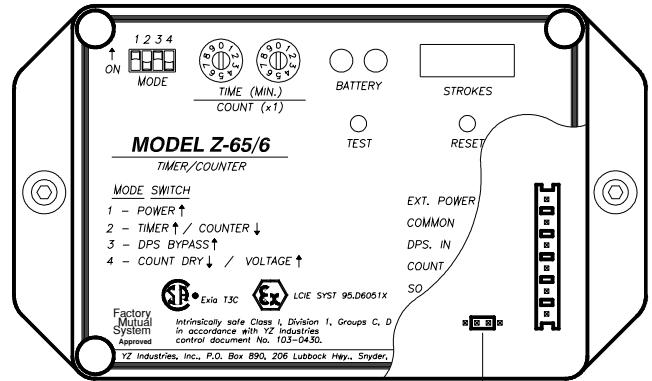

Jumper switch location for .03 - .99 counts (.xx)

12. Trouble Shooting - Counter Mode

12.5 Input Pulse Test

A. Set the mode switches as follows:

1. Position 1 and 3 on, 2 and 4 off.

B. Set the count switches to 00 to enter the diagnostic mode. This mode enables the user to determine if the proper input pulses are being received at the count input (ter. #3).

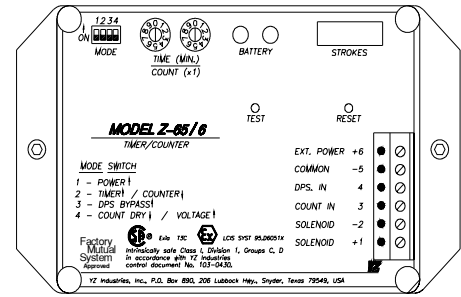
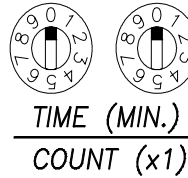
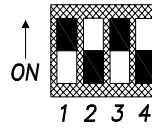

1. Dry Contact Input: mode switch 4 should be in the off position. Depress the test switch and hold. A red LED should illuminate. When the dry contact input is received at the counter input (ter. #3) the green LED will turn on and off and the red LED will illuminate again. This will normally occur very quickly and give the appearance that the green LED blinks on when the pulse input is received and removed.

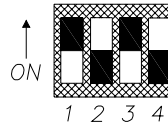

2. Voltage Pulse Input: move mode switch 4 to the on position. Depress the test switch and hold. A green LED should illuminate. When the voltage pulse input is received at the count input (ter. #3) the red LED will turn on and off and the green LED will illuminate again. This will normally occur very quickly and give the appearance that the red LED blinks on when the pulse input is received and removed.

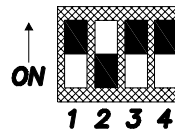
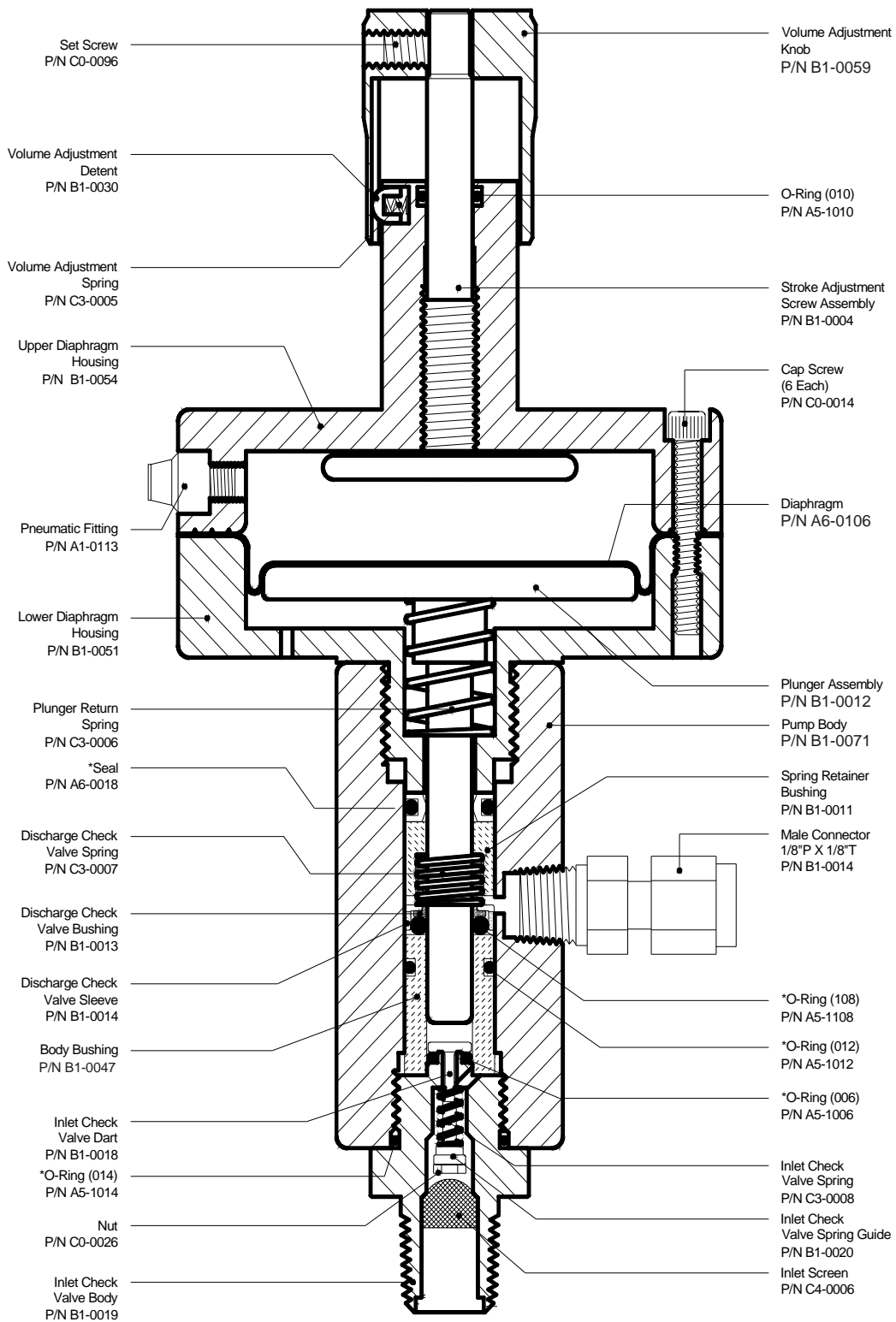
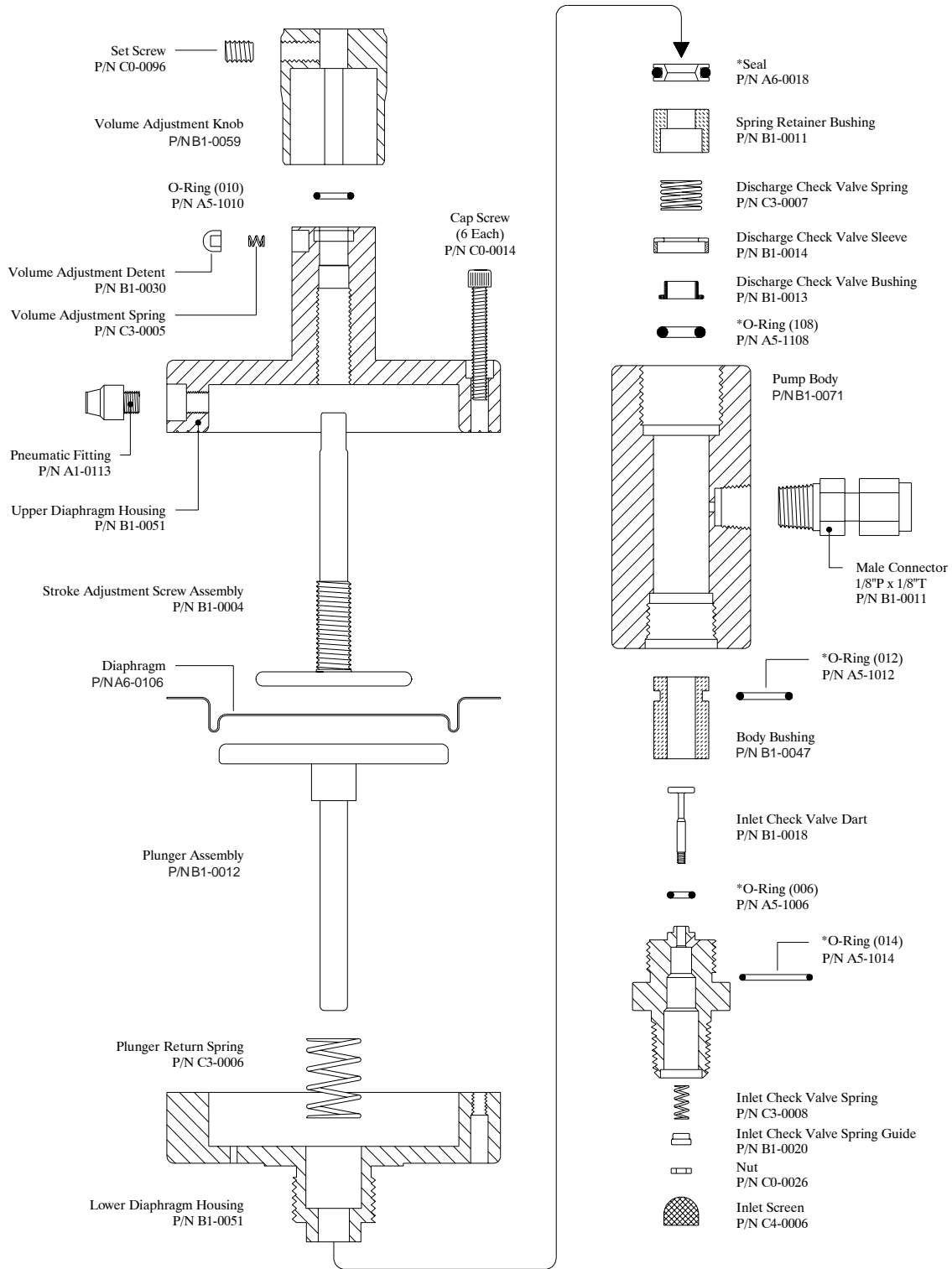

Diagram #1- DP 2000NF pump (assembled)



*DP-2000 Pump Seal Kit - P/N D3-0002

Diagram #2 - DP 2000NF pump (exploded)



*DP-2000 Pump Seal Kit - P/N D3-0002



Diagram #3

YZ filter/regulator (assembled)

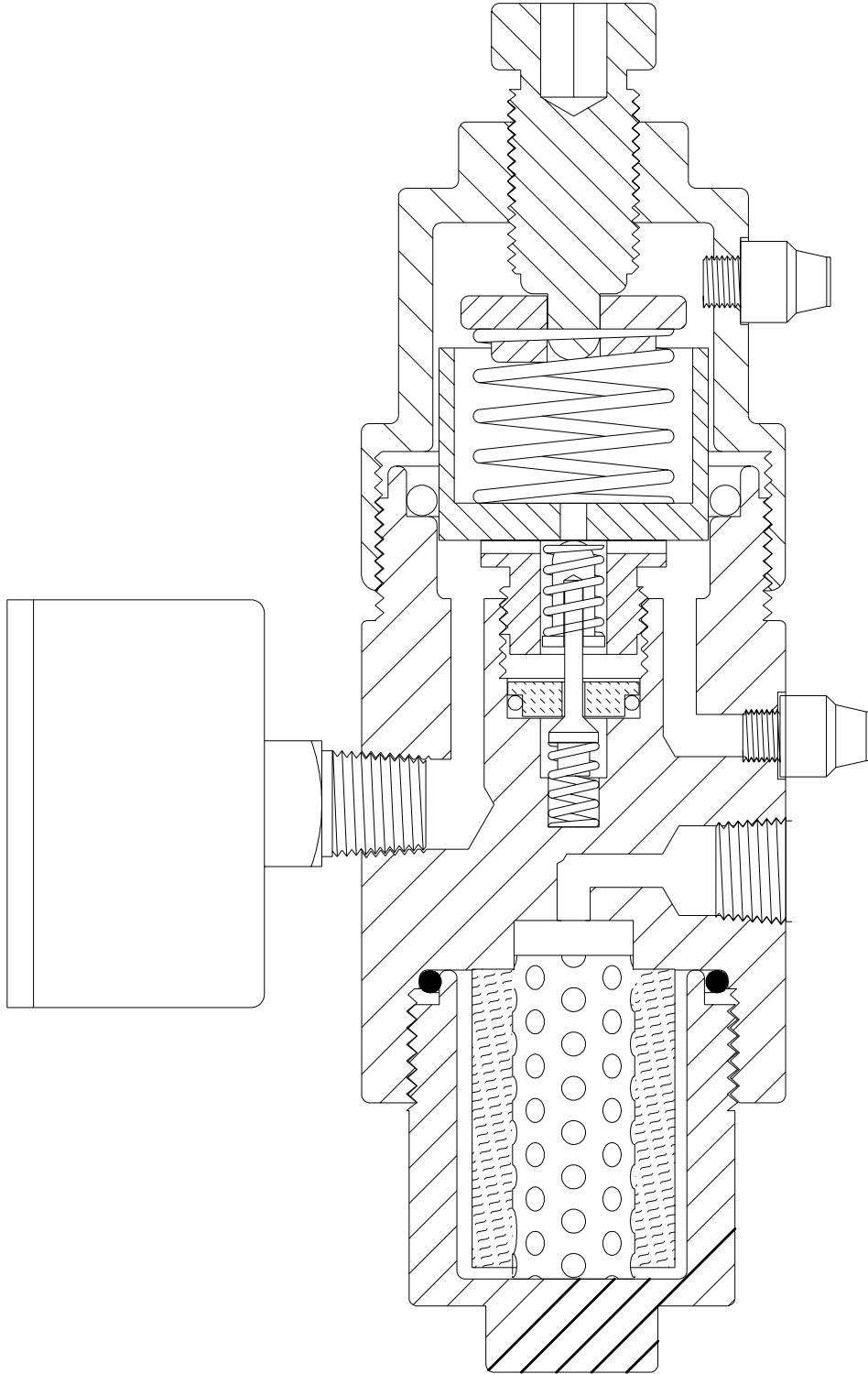
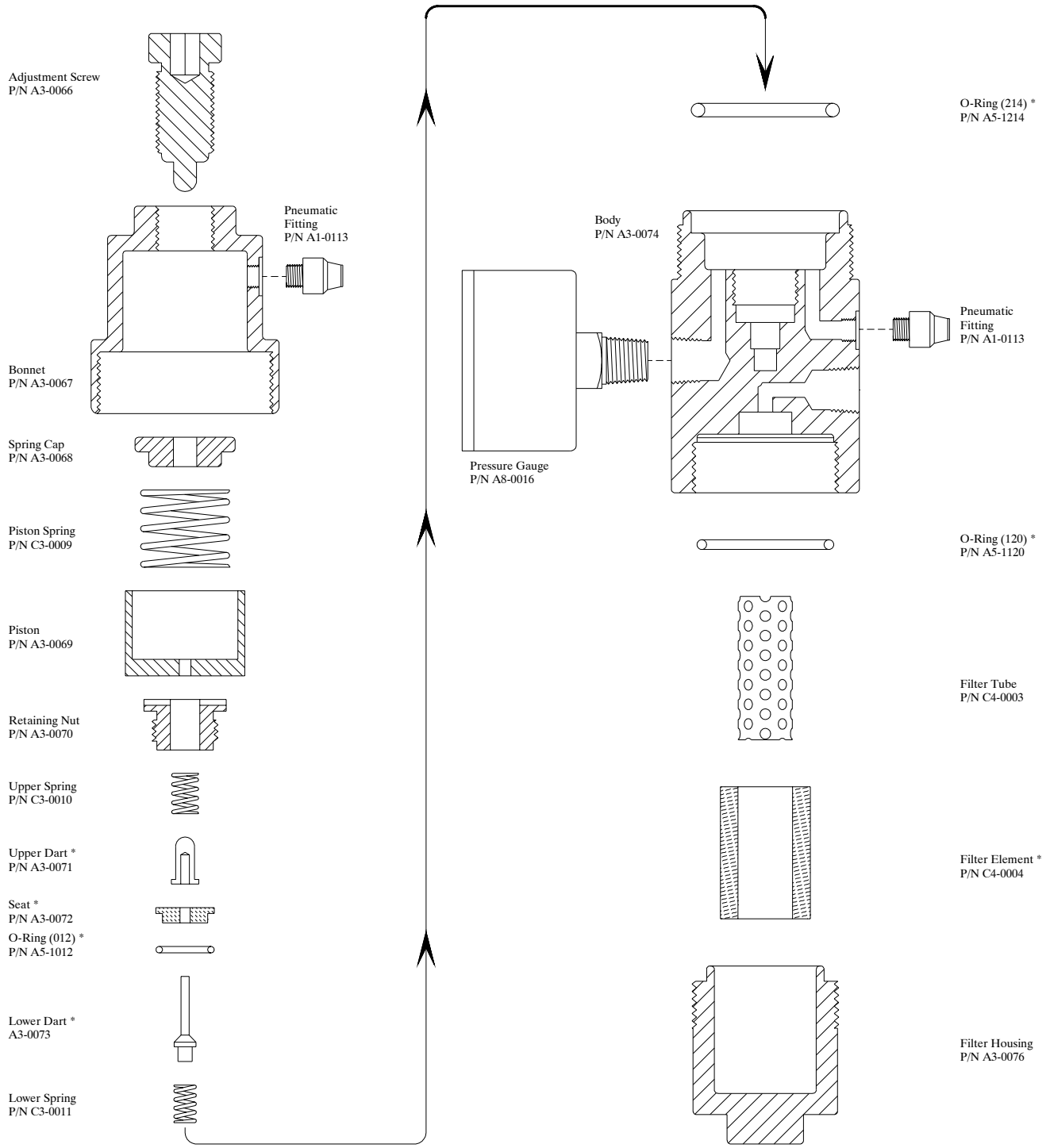

Diagram #4 YZ filter/regulator (exploded)



* Filter/Regulator Repair Kit P/N D3-0003



Diagram #5 Optional - LinkPlus

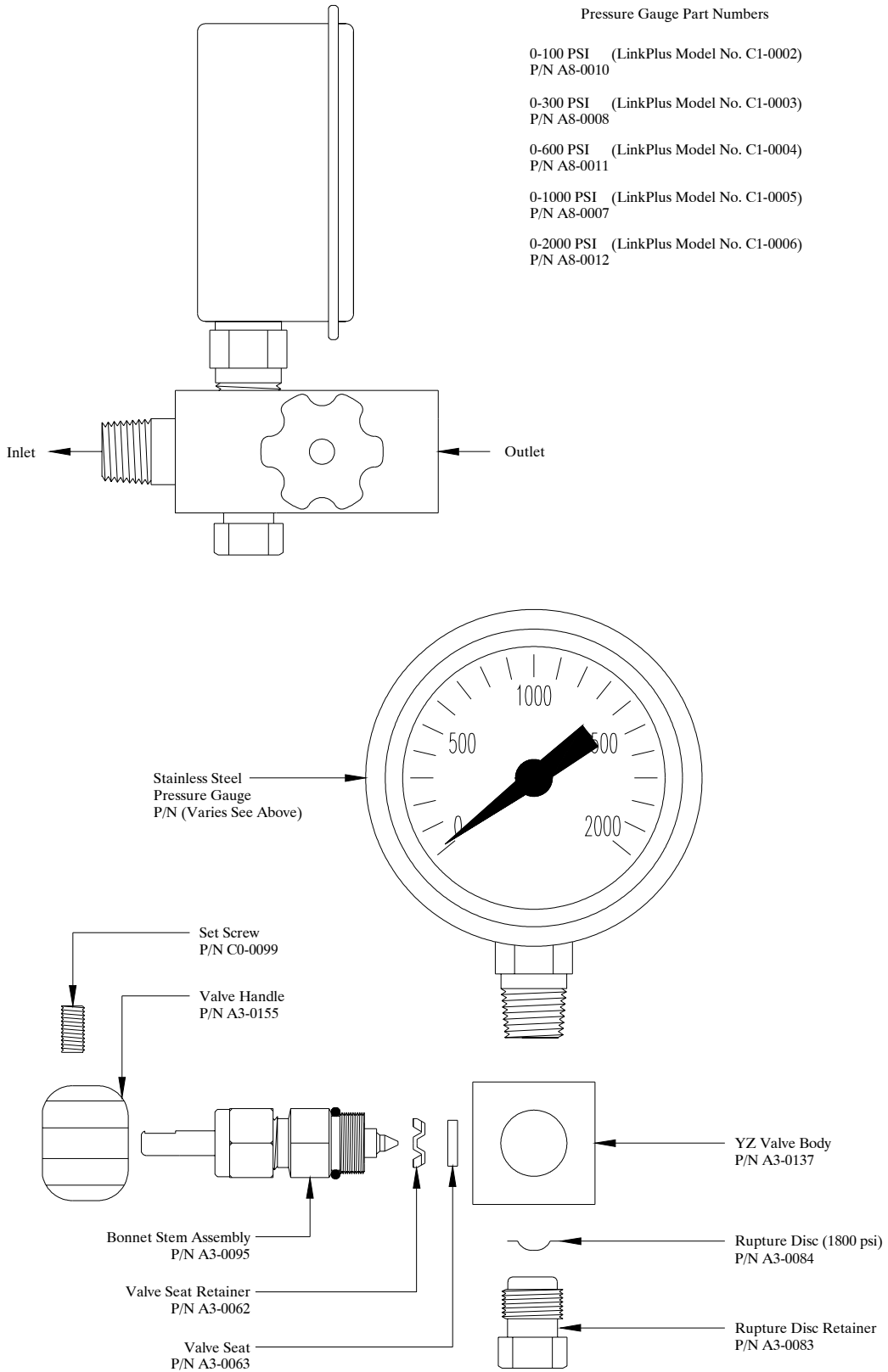

Diagram #6 Optional - DPS-2

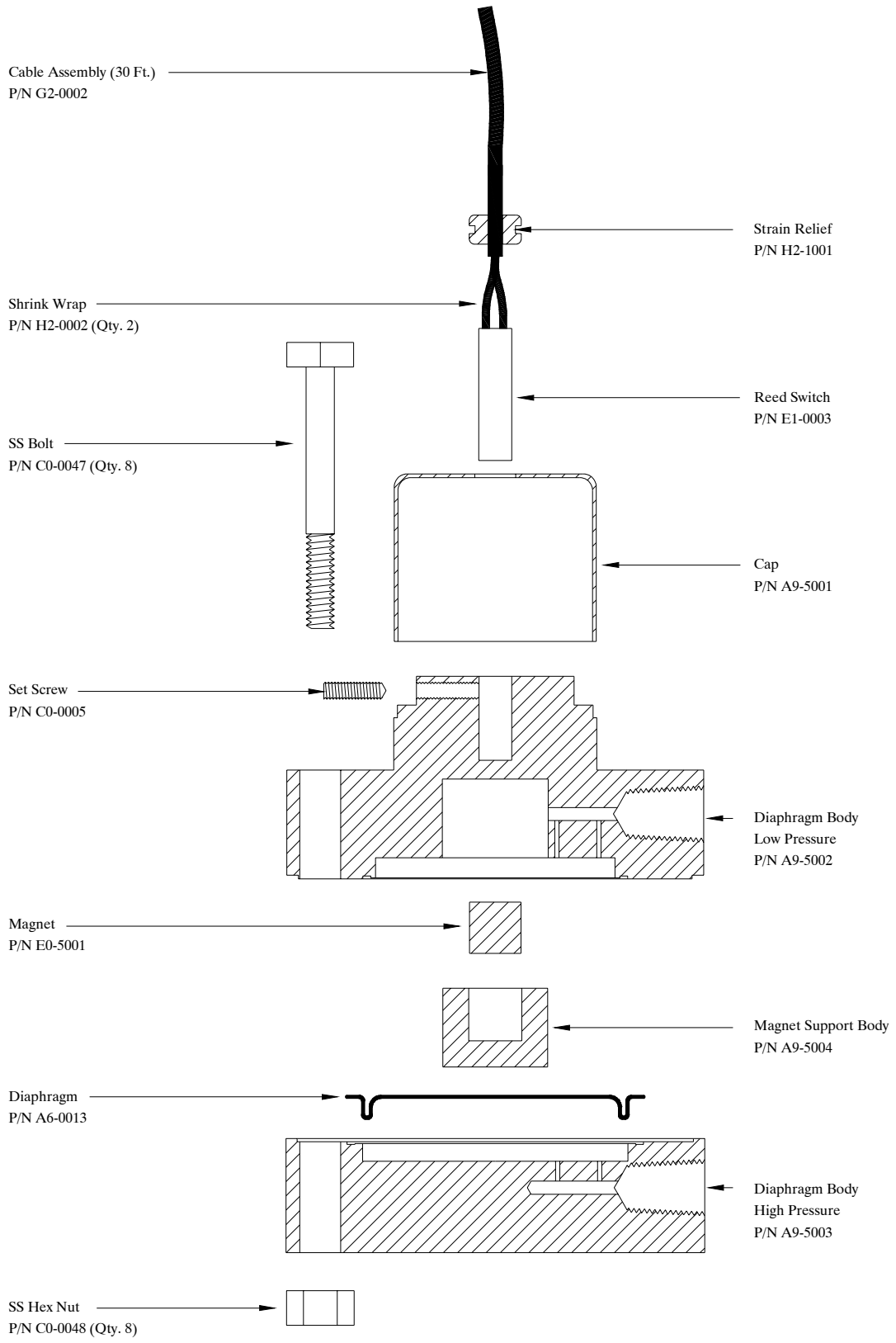
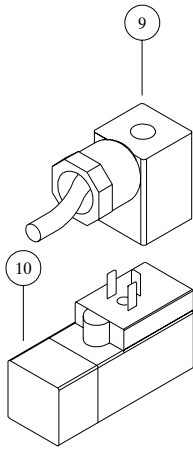

Diagram #7 - Z-65 Controller



Ref. No.	Description	Part No.	Qty.
1	Z-65/6 Controller Assembly Model Z-65/6.1	F2-0001	1
	Model Z-65/6.03	F2-0018	
2	Battery Pack	E3-2001	1
3*	Stroke Counter Assembly	G1-0001	1
4*	Terminal Strip, 6 Position	H1-0001	1
5*	BCD Switch	E1-0001	2
6*	Mode Switch	E1-0002	1
7	Face Plate Model Z-65/6.1	A9-3001	
	Model Z-65/6.03	A9-3029	
8	Thumb Screw	A9-1001	4
9	Cable Assembly	G2-0001	1
10	Solenoid Valve	A4-0001	1
11	Repair Kit*	D3-0005	1
12	Z-65/200 Fuse Replacement Kit (2 Fuses Per Kit)	D3-0142	1

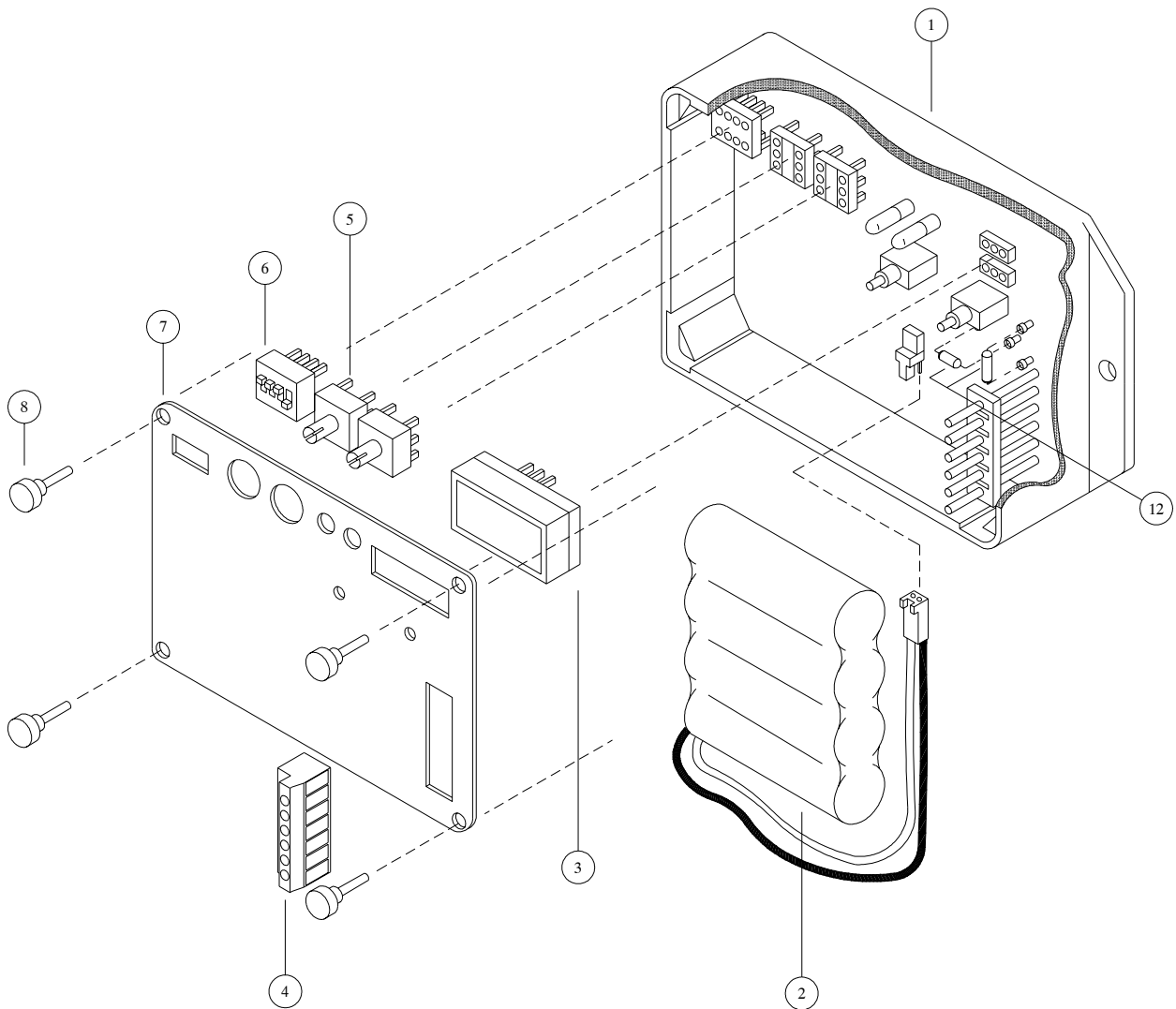
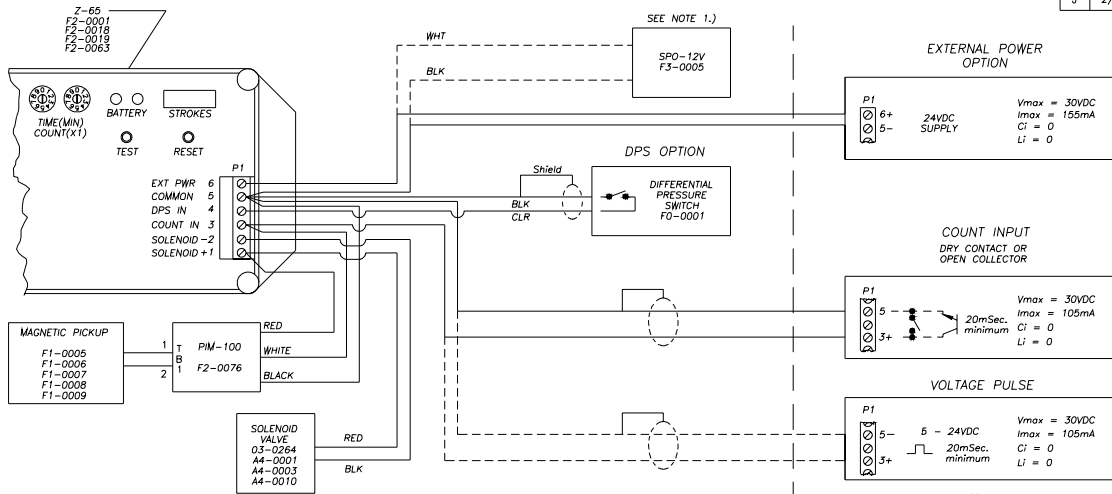

Diagram #8 - Z-65 Installation Notes/Wiring Control Documentation

System Installation Notes and Recommendations

The manufacturer's system installation instructions and the National Electric Code, Canadian Electrical Code where applicable, must be followed when installing this equipment. Tampering or replacement with non-factory components may adversely effect the safe use of the system. Only the specified batteries should be used with this apparatus. For guidance on installation see ANSI/ISA 12.6 Installation of Intrinsically Safe Instrument Systems in Class I Hazardous Locations.

REVISIONS		
REV	DATE	DESCRIPTION
D	5/15/92	
E	10/7/93	
F	2/06/95	
G	3/20/97	
H	7/13/98	ECO-088
J	2/3/04	ECO-259 [REH]



CLASS I, DIVISION 1, GROUP C,D T3C HAZARDOUS AREA EExia IIB ZONE 0 T4

$$V_{MAX} \geq V_{OC}$$

$$I_{MAX} \geq I_{SC}$$

$$C_A \geq C_i + C_{CABLE}$$

$$L_A \geq L_i + L_{CABLE}$$

CONTROL EQUIPMENT SHALL NOT USE OR GENERATE MORE THAN 250VAC

Exia INTRINSICALLY SAFE / SECURITE INTRINSEQUE

Z-65 WIRING DIAGRAM

NOTES

1.) NOT FOR USE IN EExia IIB T4 ZONE 0 AREA.

CERTIFIE CONFORME A L'EXECUTION
SIGNATURE _____ DATE _____
** NO CHANGES ARE TO BE MADE TO THIS DRAWING WITHOUT PRIOR CSA APPROVAL.

 3101 POLLOK DR. CONROE, TEXAS 77303	DRAWING NO: 103-0430
	SCALE: NTS
DESCRIPTION Z-65 WIRING CONTROL DOCUMENT	SHEET 1 OF 1 B SIZE
THIS DRAWING, AND ALL INFORMATION CONTAINED HEREIN REMAINS THE PROPERTY OF YZ SYSTEMS, INC. ALL RIGHTS ARE EXPRESSLY RESERVED AND MAY NOT BE REPRODUCED IN WHOLE OR IN PART WITHOUT YZ SYSTEMS, INC. WRITTEN CONSENT.	DRAWN: 2C DATE: 11-20-91
	CHECKED: DATE:
	APPROVED: DATE:



Diagram #9 - DuraSite Portable Sample Vessel Instructions

Purpose: The DuraSite Portable Sample Vessel permits the user to remove a liquid or gas hydrocarbon sample from a pipeline or a sampling device. This is accomplished without changing the pressure of the product or exposing it to a contaminant fluid. If properly used and maintained the DuraSite will provide many years of safe, accurate and clean sampling.

Use: The DuraSite is a very safe device to use. As with any equipment dealing with flammable products, it is mandatory that a good, thorough operator training procedure be established prior to use.

Typical use of the cylinder would be as follows:

Step 1: (In The Lab) Connect a regulated inert gas supply to the pre-charge valve. The product valve should be open. By carefully controlling the pre-charge valve and the regulator, the cylinder can be slowly charged with pre-charge gas (NOTE: This should be done slowly to prevent slamming the piston down to the opposite end). The pressure on the pre-charge pressure gauge should be brought to a reading of 10-50 psi above the expected pressure of the product in the field. Close the pre-charge valve and disconnect the gas supply. Check the pre-charge valve, relief device, and the pre-charge pressure gauge for leaks. Any leaks should be stopped before continuing. The vessel should be placed in a padded carrying case and made ready for field use.

Proceed to **EITHER Step 2, or Step 3** as required for your application.

STEP 2: FOR COLLECTION OF SAMPLE VIA SPOT SAMPLE OR FROM COMPOSITE ACCUMULATOR VESSEL.

2a: Connect the product end of the pre-charged sample vessel to the product supply.
(Sampler product removal valve, or Pipeline sample probe)
NOTE: the pre-charge pressure gauge reading should be greater than the product supply pressure reading. If not, repeat Step 1 above.

2b: Once the vessel is connected to the product supply, it is necessary to vent a small amount of product prior to filling the vessel. This assures fresh product and removes any air or gas when dealing with liquids. This can be done by loosening the product purge valve a very small amount until the product is purged. After thorough purging, the product purge valve should be tightened.

2c: The product pressure gauge reading should be 10-50 psi below the pre-charge pressure gauge reading. By carefully opening the pre-charge valve, the pressure becomes equalized, then begins to drop below the product pressure. The pre-charge valve should be carefully controlled so as to not vent the pre-charge gas too fast.

2d: When the cylinder becomes a maximum of 80% full (see volume indicator), all valves should be closed. The product connection is slowly broken in order to vent any trapped product. After vessel removal, all connections should be checked for leaks and the pre-charge and product valve ports capped to prevent leakage.

2e: Pack the DuraSite in appropriate carrying case to meet D.O.T. guideline, with D.O.T. paperwork and transport to lab for analysis.

STEP 3: FOR DIRECT CONNECTION TO SAMPLER.

3a: Connect the sampler discharge port to the product inlet port to the DuraSite using 1/8" stainless steel tubing.

3b: (Gas sampling) Connect the pre-charge port to the DuraSite to the pipeline for pre-charge pressure (Proceed to step 3d), or configured like the liquid sample application below. (Step 3c)

3c: (Light sampling) Pre-charge the DuraSite as indicated in Step 1, then install a pressure relief valve to the pre-charge port and open the pre-charge valve on the DuraSite. (The pressure relief valve should have a relief pressure setting of approximately 100 psi above line pressure.)

3d: Open the product inlet valve of the DuraSite and the purge valve on the sampler. Next open the purge valve on the product end of the DuraSite and allow product to purge all lines and connections out.

3e: Close purge valves and begin sample cycle.

3f: At the end of sample cycle, close product inlet valve on the DuraSite and remove the DuraSite. Pack the DuraSite in appropriate carrying case to meet D.O.T. guideline, with D.O.T. paperwork and transport to lab for analysis.

Step 4: (In The Lab) Prior to analysis, the product should be mixed. This is accomplished simply and efficiently by inverting the cylinder end-over-end, causing the mixing ball to fall through the product. Approximately 10-12 trips of the mixing ball through the product assures a homogenous solution.

Step 5: The regulated pre-charge gas should be reconnected to the pre-charge side of the cylinder. The pre-charge gas supply should remain open during analysis.

Step 6: Purging a small amount of product from the vessel removes unmixed product from the tee, relief device, gauge, etc. The unit can now be connected to a chromatograph and the product analyzed.

Step 7: After analyzing, the remainder of the product should be dumped and the vessel properly cleaned. Normal cleaning can be accomplished by rinsing the product end with a petroleum solvent and flushing with acetone. If a more thorough cleaning is required, the vessel should be disassembled.

WARNING: A portable sample vessel should never be filled to more than 80%. This allows a 20% pre-charge cushion to absorb thermal expansion of the product.

Shipping: Extreme care should be taken when preparing a vessel for shipment. Both valves should be capped to prevent possible leakage. The vessel should be placed in a snug-fitting, well-padded and durable case. All applicable DOT regulations should be adhered to.

DuraSite-9 Sample Vessel,

(3600 psi maximum working pressure)

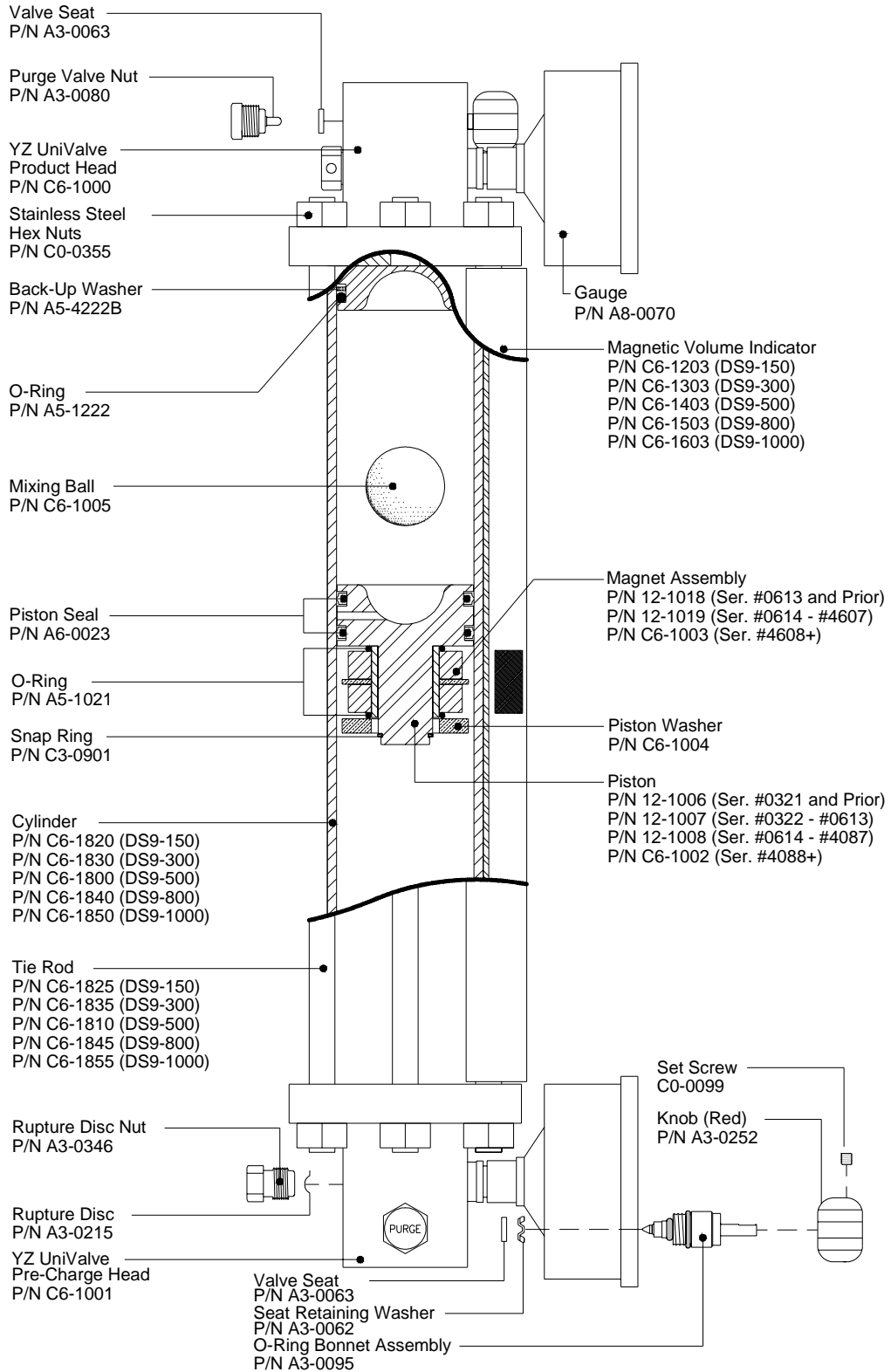



3101 Pollok Drive

Conroe, Texas 77303

P: 936.788.5593

F: 936.788.5720

Em: Service@yzhq.com

Web: www.yzsystems.com

YZ Systems, Inc. represents and warrants that for a period of 3 years from receipt of the product: (1) the product will be free from defects in materials and workmanship; and (2) the product will perform substantially in accordance with product manuals, literature, or documentation. Any written or oral information or advice given by YZ representatives, agents, or employees will in no way increase the scope of this warranty. If the product fails to comply with the warranty set forth herein, YZ's entire liability and the customer's exclusive remedy will be replacement of the product(s) or, at YZ's option, YZ's reasonable effort to make the product meet the warranty set forth herein. **YZ disclaims all other warranties, either expressed or implied, including but not limited to, implied warranties or merchantability and fitness for a particular purpose, with respect to the product.** This limited warranty gives you specific legal rights. You may have others, which vary from state to state. **These remedies are not available outside of the United States and Canada.** In no event shall YZ or its suppliers be liable for any damages whatsoever (including, without limitation, damages for loss of profits, business interruption, loss of information, or other pecuniary loss) arising out of the use of or inability to use the product, even if YZ has been advised of the possibility of such damages. Information contained in this document is subject to change without notice and does not represent a commitment on the part of YZ Systems, Inc. All prices quoted are in U.S. dollars, F.O.B. Snyder, Texas. NJEX is a trademark of YZ Systems, Inc. All other product names and/or registered trademarks are the property of their respective holders. YZ support services are subject to YZ's then-current prices, terms, and conditions, which are subject to change without notice. All prices and specifications, if published, are subject to change without notice.