

NJEX LVO 610G

NJEX LVO 610F

NATURAL GAS ODORIZATION SYSTEM



YZ[®]
SYSTEMS
An Ingersoll Rand Business

NJEX LVO 610G, 610F INSTRUCTION & OPERATING MANUAL

Version: 07-2024

610G TABLE OF CONTENTS

610G Table of Contents.....	I
Section 1: First Things To Know About The 610G	1
How to Use this Manual.....	1
Operation Specifications.....	2
Theory of Operation.....	2
System Accessories	3
Section 2: System Installation.....	4
Standard System Components.....	4
System Flow Schematic	5
Standard System Mounting	6
Standard System Connections.....	7
Section 3: Filling the Bulk Odorant Tank	8
Filling the Tank for the First Time.....	8
Refilling the Bulk Odorant Tank	9
Section 4: System Control & Electronics.....	10
Overview.....	10
Section 5: Programming the Z-100 Controller	11
Controller overview.....	11
Home Screen.....	11
Totalizer	12
Pump Alarm Screen.....	12
Using the Z-100 Controller	13
Main Menu.....	13
System ON/OFF	14
Selecting Z-100 Operational Mode.....	14
Timer Mode	14
Counter Mode.....	14
Analog Mode	15
Changing Z-100 Settings.....	16
Remote Inhibit	16
Pump Spacer.....	17
Back Pressure	17
Density.....	17
Relay Output.....	17
Relay Function.....	17
Diff Alarm Count	18
Alarm Sources	18
Battery Low.....	18
Solenoid.....	18
Pump Flow.....	18
Clock Menu.....	19

610G TABLE OF CONTENTS

Resume On Power Loss.....	19
Units	19
Logs	19
DOU Logs	19
Config Logs	20
Event Logs	20
MM100.....	20
Test	20
Test / Prime	21
Inhibit Test	21
Pulse Test	21
Battery Test	22
Relay Output Test	22
Screen Test	22
Odorant output pulse test	22
Section 6: Programming for Proportional-to-Time Operation.....	23
Setting Operator Input Parameters (Z100 Controller Setup).....	23
Section 7: Mechanical System	24
Overview.....	24
NJEX LVO Gas Filter	25
Model 6000 pump.....	26
Flow Switch	27
Section 8: System Maintenance.....	28
Preventative Maintenance Schedule	28
Recommended Spare Parts List.....	28
Section 9: 610G / 610F System Troubleshooting	29
How to Use This Section	29
SAFETY NOTES	29
Step-by-Step Resolution.....	29
Battery Power	30
Troubleshooting: Pump Performance.....	31
Troubleshooting: Flow Switch.....	32
Appendix A: Illustrations	33
NJEX LVO Model 6000 Pump Assembled.....	33
NJEX LVO Model 6000 Pump Actuation Assembly, Exploded View	34
NJEX LVO Model 6000 Pump Check Valve Assemblies, and Seals, Exploded View	35
NJEX LVO Gas Filter	36
NJEX LVO Wiring Control Document	36
Installation Drawing Z-100 Controller Wiring	36
Pump Control Document	42

SECTION 1: FIRST THINGS TO KNOW ABOUT THE 610G

How to Use this Manual

The NJEX LVO 610G, 610F Operations Manual is a step-by-step guide containing the procedures needed to work with the 610G or 610F System. The NJEX LVO System series of odorizers implement the most advanced technology available in the industry. It is recommended that the technicians working with the NJEX LVO Odorization Systems study the manual prior to initiating work on the system for the first time.

Typographic Conventions

To aid in readability, this manual uses several typographic conventions. References to illustrations, photographs, and other related content will appear in italicized text along with the location of where to find the item in the manual. Digital versions of the manual, available in Adobe Acrobat™ PDF format, will be highlighted further in blue italic text indicating the copy retains a hyperlink to the referenced item.

Items that require action, for example the pressing of a key for programming the controller, will feature the action item in sentence case **Test** followed in normal text by the item such as, the **Test** key or **Power** switch.

Starting with [Section 4, System Control & Electronics](#), the manual will begin discussing the in-depth operation of the electronic controller where many of these typographic conventions will be found. In the discussion about the controller, the technician will learn about the multiple switches used to program the controller for operation.

Getting Help

This manual provides solutions to typical questions about the 610G/610F system. If the answer can not be found within this manual, contact YZ Systems at:

T: 1.281.362.6500

T: 1.800.653.9435

E: techsupport@yzhq.com

When calling, have this manual close at hand. Whether calling or writing, please include in your communicate the following information:

- The serial number of the NJEX LVO System and the version number of this manual. The serial number is located inside the enclosure door. The version number of this manual located at the bottom of each page.
- A description of the problem and, when the problem occurred.

SECTION 1: FIRST THINGS TO KNOW ABOUT THE 610G

Operation Specifications

Maximum recommended Odorant Output:	0.5 gallons/day (200 cc/day)
Maximum Operating Pressure:	1,440 psig (99.28 Bar (g))
Operating Temp Range:	-4 to 140° F. (-20° C to 60° C)
Power Supply:	LBP-14 Battery Ext. Power Option, Solar Option
Gas Flow Input Signal:	Pulse (Dry contact or voltage pulse) Analog (4-20mA)

Theory of Operation

The 610G / 610F systems are based on several key components: the Z-100 Electronic Controller, the 6000B pump, and a low powered solenoid used to actuate the pump. The Z-100 determines the rate at which the pump is actuated.

The 610F systems include a flow switch to verify injected odorant.

The Z-100 controller has 2 modes of operation, Proportional to Time, and Proportional to Flow. The 6000B pump displacement is normally set by the factory, this can be modified using optional stroke length spacers for the 6000B pump. See [Figure 18](#) for more information.

During operation, the number of pump strokes commanded, pump strokes sensed (610F model), and odorant injected as displayed on the Z-100 Home Screen.

If enabled, an external relay contact from external device can be connected to the Inhibit/NBS input to inhibit and restart pump operation.

Proportional to Time (Timer Mode) Operation: In Timer mode, the pump is actuated at a regular time interval by the Z-100 controller determined by user configurable cycle time setting. See [Section 5](#) programming, for additional information.

In Timer Mode, the Z-100 controller operates as a recycling timer, and the pump is operated at a rate determined by user settable parameter. The cycle time range is 0.1min to 180.00min.

Proportional To Flow Operation: For Proportional To Flow operation there are 2 modes. Analog Mode, and Counter Mode

In Analog mode, the Z-100 controller monitors a 4-20mA signal representing pipeline flow from an external device. The flow signal along with several user entered parameters is used to determine the actuation rate required to maintain the target injection rate with pipeline flow changes.

See [Section 5](#) for additional information and features available in Analog Mode.

In Counter mode, the Z-100 controller functions as a pulse divider. The controller monitors and counts incoming pulses representing a volume of gas flow/pulse from external device. When the number of pulses accumulated equals the pulse divider setting the controller actuates the pump. The pulse divider can be set from 1 to 10,000 in increments of 1. See [Section 5](#) for additional information.

SECTION 1: FIRST THINGS TO KNOW ABOUT THE 610G

Power Options:

Long-Life Battery: The controller operates using a replaceable internal battery pack. The battery pack state of charge is monitored. Status is indicated using both the LED and user interface. Each time the pump is actuated, the LED will flash to indicate the battery status. Green if good, and Red if capacity is low. Once observed, the pack should be replaced soon to avoid loss of operation. Typically a system will continue to operate in for at least 1 week after the low battery condition is indicated. When the battery alarm is enabled, and the battery pack voltage is low, the red LED will blink at a 5 second interval. If the battery alarm is not enabled and the battery voltage is low, the LED will blink red with each pump stroke. If the battery capacity is good, the LED will blink green with each pump stroke.

The battery voltage can be checked in the battery test screen within the test menu.

Typical battery life is eighteen months based on a two minute / stroke rate and average ambient temperatures.

Customer may provide an external intrinsically safe power supply. If an external power supply is used, refer to the Wiring Control Document in [Figure 20](#) for additional wiring requirements. The wiring must adhere to the Wiring Control Document as well as local codes and regulations for the installation site.

System Accessories

- **Odorant Injection Probe**, includes a 316 stainless steel probe and isolation valve for location at the pipeline. When ordering, please specify pipeline connection required, 1/2" or 3/4".

- **Odorant Injection Probe with Sightglass**, (P/N A1-0238) 1/8" drop adapter includes a 316 stainless steel probe, visual odorant sight indicator, and an isolation valve for location at the pipeline. When ordering, please specify pipeline connection required, 1/2" or 3/4".
- **1/8" stainless steel discharge tubing Inline Check Valve**. For placement in the odorant discharged tubing line immediately preceding the probe assembly, (P/N A3-0438).
- **1/4" stainless steel tubing Dielectric Isolator Union**. These should be installed in every tubing line that attaches the odorizer to the pipeline in any manner. For example the supply gas, odorant discharge, and differential pressure switch connections, (P/N A1-0182).
- **NJEX LVO Scrubbers**. These filters are designed to scrub the exhaust gas vented from the pumps. They are available by ordering P/N C4-0018, 15 gallon scrubber.

A complete line of odorization accessories ranging from deodorizing gas scrubbers to injection probes is available through YZ. Please contact your local representative or YZ toll free at 800.344.5399. For technical support call 800.653.9435.

Application Notes

- Battery capacity for the NJEX LVO will be determined by pump cycle time and ambient temperatures. The more often the pump is actuated with ambient temperatures approaching minimum or maximum of operating range for long periods will result in considerably shorter battery life.
- The 610G / 610F Odorant Tank should be mounted above the 6000B pump to provide inlet pressure to the pump and reduce the possibility of vapor lock.

SECTION 2: SYSTEM INSTALLATION

Standard System Components Figure 1

Primary components of the NJEX LVO-610G & 610F are as follows:

- A. System Odorant Tank. The odorant tank is tested and pre-assembled with a valve package including a visual level indicator.
- B. System Controller. Controller with internal battery pack (if applicable).
- C. Odorant Injection Pump. The NJEX LVO 6000B is a pneumatically actuated, positive displacement plunger pump.
- D. System Enclosure. Houses the Model 6000B pump, the Z-100 Controller, the actuation gas manifold and the odorant discharge manifold. IP54 rated.
- E. NJEX LVO Gas Filter. Installed between the actuation gas regulator and the actuation gas manifold, this filter provides a 25 micron coalescent filtration to insure a clean pneumatic supply.
- F. Flow Switch (610F models only). Installed in the discharge line of the pump to confirm odorant flow.

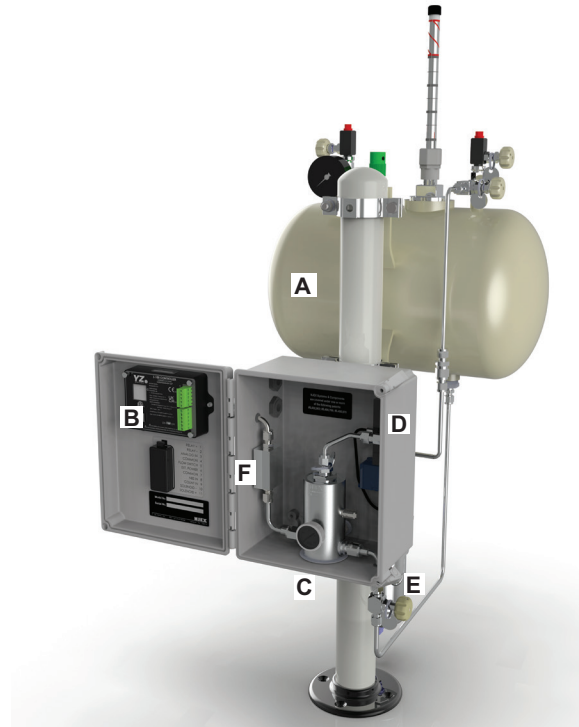
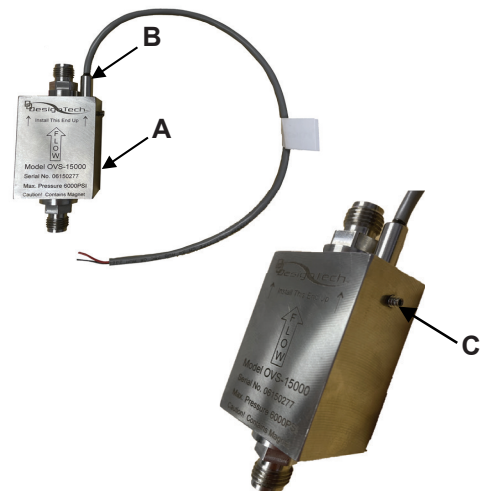

Figure 2

Flow Switch Components:

- A. Flow Switch Body: Houses internal Flow Switch components.
- B. Flow Switch Reed Relay: Adjustable contact momentarily activated when odorant flow is sensed.
- C. Flow Switch Set Screw: Set screw holds the Flow Switch Contact in place. **Note:** Flow switch placement is factory set. Please refer to adjustment procedure in Section 7.



System Level Approvals:

CLASS I, DIVISION 1, GROUPS C-D, T4
 PROVIDES INTRINSICALLY SAFE OUTPUTS FOR CLASS I, DIVISION 1, GROUPS C-D AND CLASS I, ZONE 0, GROUP IIB
 CLASS I, ZONE 0, AEx ia [ia] IIB T4 Ga

Ex h ia [ia] IIB T4 Ga
 Ⓜ II 1(1) G Ex h ia [ia] IIB T4 Ga
 -20°C ≤ Ta ≤ +60°C
 IP54

ETL23CA104230006X
 IECEX ETL 23.0013X
 ETL24ATEX0290X
 ITS24UKEX0707X

Conforms to UL STD 60079-0, 60079-11, 61010-1, 80079-36, 80079-37
 Certified to CSA STD C22.2 NO. 60079-0, 60079-11, 61010-1-12, 80079-36, 80079-37

SECTION 2: SYSTEM INSTALLATION

System Flow Schematic

Figure 3

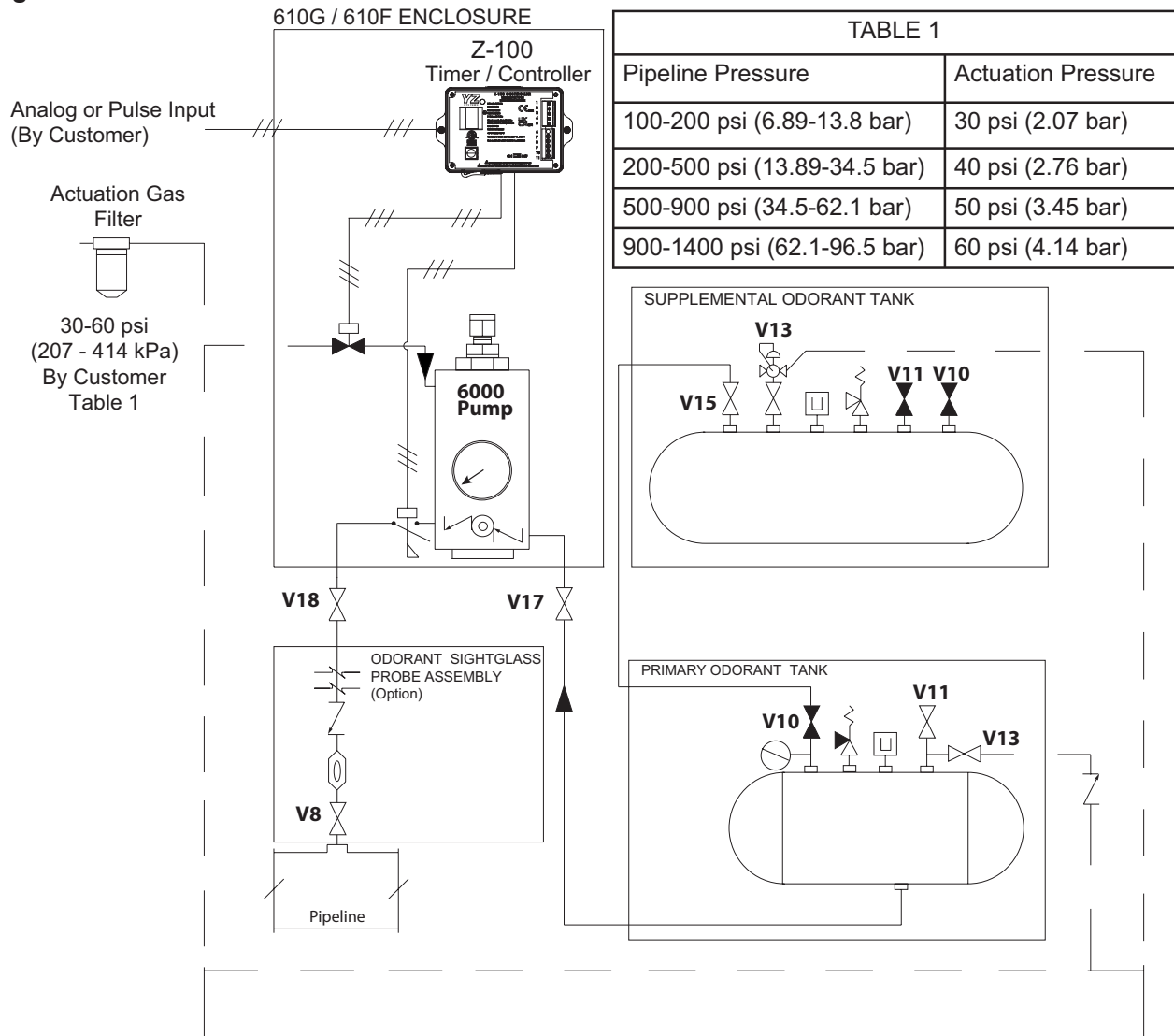

Legend

- | | | |
|---|--|---|
| Actuation Gas ———— | Normally Closed Valve | Pressure Gauge |
| Odorant ————— | Normally Open Valve | Level Indicator |
| Electrical ———// | Check Valve | Pressure Relief Valve |
| | Solenoid Valve | Pressure Regulator w/ Gauge |
| | Flow Switch | |
| V8 Injection Probe Pipeline Isolation Valve | V11 Odorant Storage Tank Vapor Return Valve | V15 Odorant Storage Tank Supply Isolation Valve |
| V10 Odorant Storage Tank Fill Valve | V13 Odorant Storage Tank Blanket Gas Isolation Valve | V17 Odorant Inlet Isolation Valve |
| | | V18 Odorant Discharge Line Isolation Valve |

SECTION 2: SYSTEM INSTALLATION

Standard System Mounting

1. Securely attach a section of 2" pipe in a vertical configuration at the location where the NJEX LVO 610G / NJEX LVO 610F is to be installed. Using the mounting clamps provided with the NJEX LVO 610G / NJEX LVO 610F system, attach the system to the pipe.
2. Connect a ground wire from the 2" pipe to a properly installed ground rod. All wiring and bonding must adhere to local laws and regulations for the location of the installation.

Figure 4

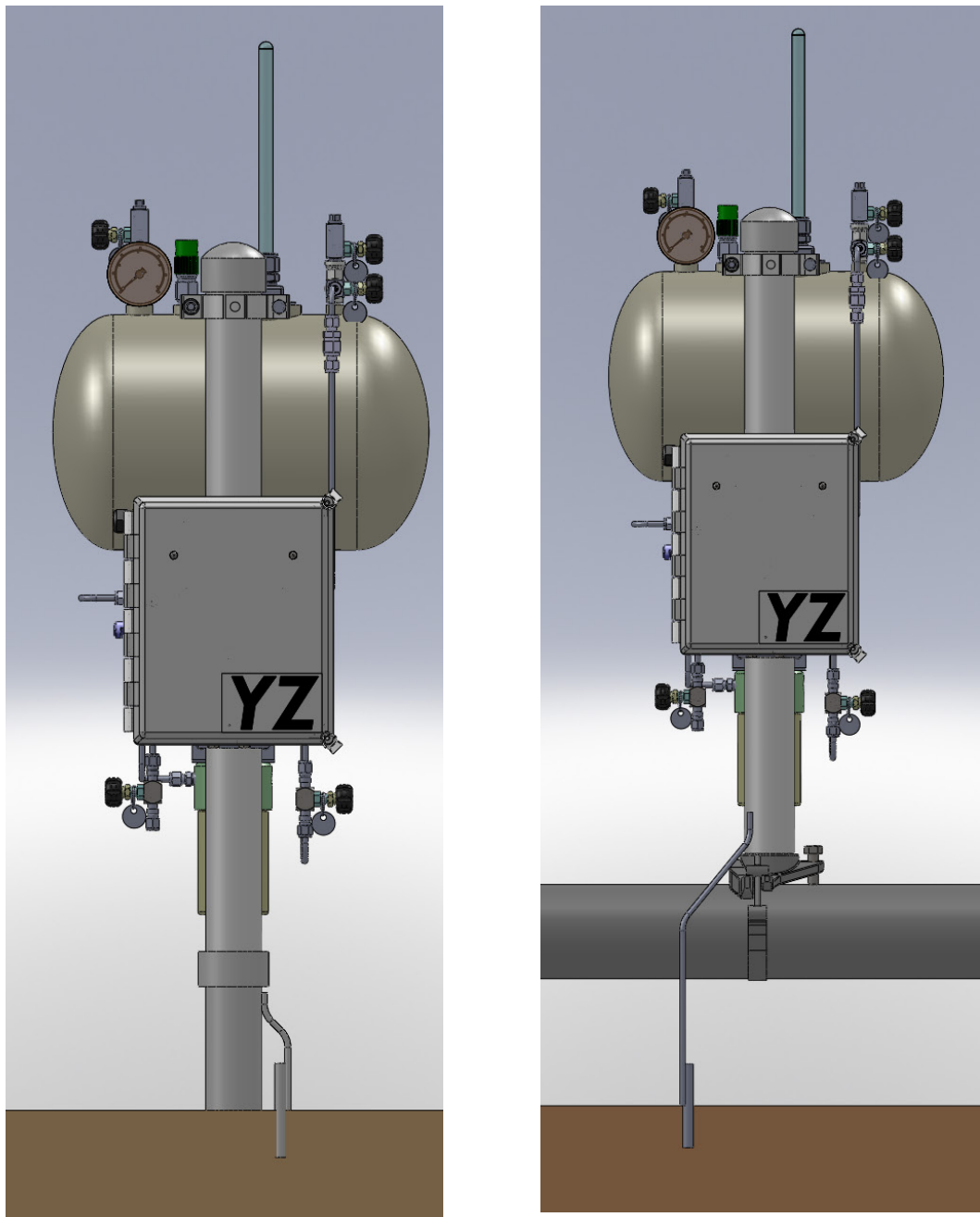

SECTION 2: SYSTEM INSTALLATION

Standard System Connections Figure 5

Required field connections to place the 610G, 610F into operation are as follows:

1. Connect the regulated actuation gas source (30-60 psi, 2.1-4.1 bar, by customer, refer to [Table 1, Page 5](#)) to the NJEX LVO gas filter inlet.

NOTE: At temperatures below 32°F (0°C), conditioning of the actuation gas supply may be required. Where the actuation gas supply has a high water content and/or a low hydrocarbon dew point, additional actuation gas filtration or heating of the actuation gas supply may be necessary. Bottled nitrogen can also be used during cold operating conditions to avoid condensation in the actuation gas supply line. In addition, operation at extreme temperatures will affect seal and o-ring performance. To prolong the service of seals and o-rings, adequate heat should be provided to maintain an operating environment above 32°F (0°C).

2. Connect the pump discharge valve fitting to the pipeline connection.

Installation Guidelines

- We recommend that the tubing from the 610 NJEX LVO be adapted to 1/8" tubing before it reaches the sight glass.
- A 50 psi in-line check valve should be located just before the sight glass. (1/8" in-line C.V. P/N A3-0438)
- The sight glass should be fitted with a 1/4" MNPT x 1/8"t bore through fitting (P/NA1-0283) and 1/8" S.S. tubing extending through the bore of the sight glass fitting until it just protrudes from the 1/4" dripper point.

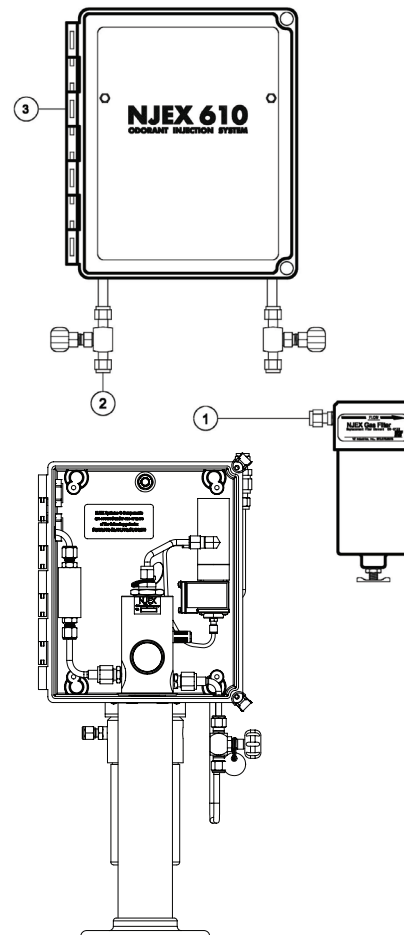

CAUTION:

Excessive tubing lengths should be avoided. Installation of the NJEX LVO Odorization system should be as close to the point of injection and Odorant Storage Tank as possible. Maximum tubing length should not exceed 15' (4.5 meters) with the tubing size maintained as indicated in this manual. If longer tubing lengths are required consult YZ Systems Technical Services at 800.653.9435 or 1.281.362.6500

SECTION 3: FILLING THE BULK ODORANT TANK

Filling the Tank for the First Time

CAUTION:

Odorant has a very strong odor, which if allowed to escape into the atmosphere may cause problems in the local community. Take necessary precautions when filling an odorant storage tank to assure that the local community is not disrupted during the filling process. Verify that the entire system has no pressure in it before beginning. Additionally, all personnel should wear protective clothing, and use equipment as recommended by the chemical manufacturer during this time. If you are uncertain about any aspect of the odorant itself, you should contact the manufacturer of your chemical prior to proceeding. **The MAXIMUM amount of odorant in the standard tank should never exceed 4 gallons.**

1. Verify correct position of valves before beginning, *figure 5*.
Closed: V10, V11 and V13
2. Attach inert or natural gas supply to V10.
3. To purge the tank open valve V10 to introduce inert or natural gas to the tank to begin displacing any ambient air from the empty tank. Continue until pressure on the gage located directly below V10 is observed, then partially open V11 to allow ambient air from the tank to begin flowing out. Allow this process to continue until all ambient air from the tank is purged, and

only inert gas or natural gas is emitting from this valve, then close V11 and V10. The time required to accomplish this task will vary with the tank size.

4. Vent purge gas by opening V11 partially until tank pressure just reaches zero, and then close V11.
5. Attach odorant supply to V10, open V10, and begin transferring odorant to the bulk tank.
 - The tank level indicator will not start to rise until approximately 0.5 gallons of odorant is in the tank.
 - 1 gallon is approximately the thin line above the fitting.
 - 2.5 gallons is approximately the next thick line below the red keep-out.
 - 4 gallons is about where the red diagonal keep-out mark starts.
6. Connect a line from V11 to a flare or vapor recovery device, and open V11.

CAUTION:

Fill tank to a maximum level of 80% of the tank capacity (4 gallons). Stay below the red-diagonal keep-out.

7. Close V10 and V11, and remove odorant transfer equipment, and line to flare or vapor recovery device.
8. Continue through the remaining procedures in this manual.

Figure 6

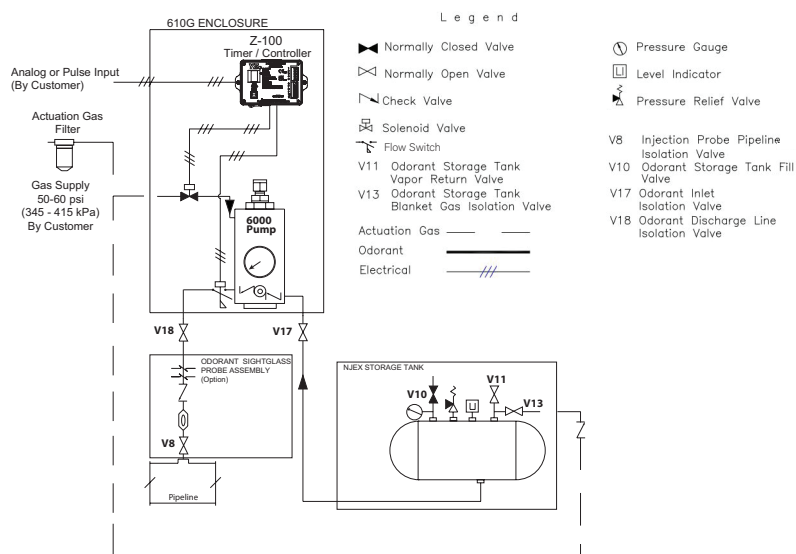

SECTION 3: FILLING THE BULK ODORANT TANK

Refilling the Bulk Odorant Tank

CAUTION:

Odorant has a very strong odor, which if allowed to escape into the atmosphere may cause problems in the local community. Take necessary precautions when filling an odorant storage tank to assure that the local community is not disrupted during the filling process. Verify that the entire system has no pressure in it before beginning. Additionally all personnel should wear protective clothing, and use equipment as recommended by the chemical manufacturer during this time. If you are uncertain about any aspect of the odorant itself, you should contact the manufacturer of your chemical prior to proceeding.

1. Ensure the Z-100 controller is powered off by placing the power switch in the OFF position, or by using the navigation switch to place the SYSTEM in OFF mode.
2. Verify correct position of valves before beginning, Figure 6.
Closed: V10, V11, V13
3. Connect a line from V11 to a flare or vapor recovery device, and open V11.

4. Attach odorant supply to V10, open V10, and begin transferring odorant to the bulk tank.

CAUTION:

Fill tank to a maximum level of 80% of the tank capacity. Stay below red keep-out zone.

- The tank level indicator will not start to rise until approximately 0.5 gallons of odorant is in the tank.
- 1 gallon is approximately the thin line above the fitting.
- 2.5 gallons is approximately the next thick line below the red keep-out.
- 4 gallons is about where the red diagonal keep-out mark starts.

5. Close V10 and V11, and remove odorant transfer equipment, and line to flare or vapor recovery device
6. Open V13 until the storage tank pressure is 10 psig.
7. If powered OFF, power ON the Z-100 controller by moving the power switch to the ON position. Restart the system using the navigation switch.
Note: If resume on power up setting is enabled, the system will automatically restart upon power up

Figure 7

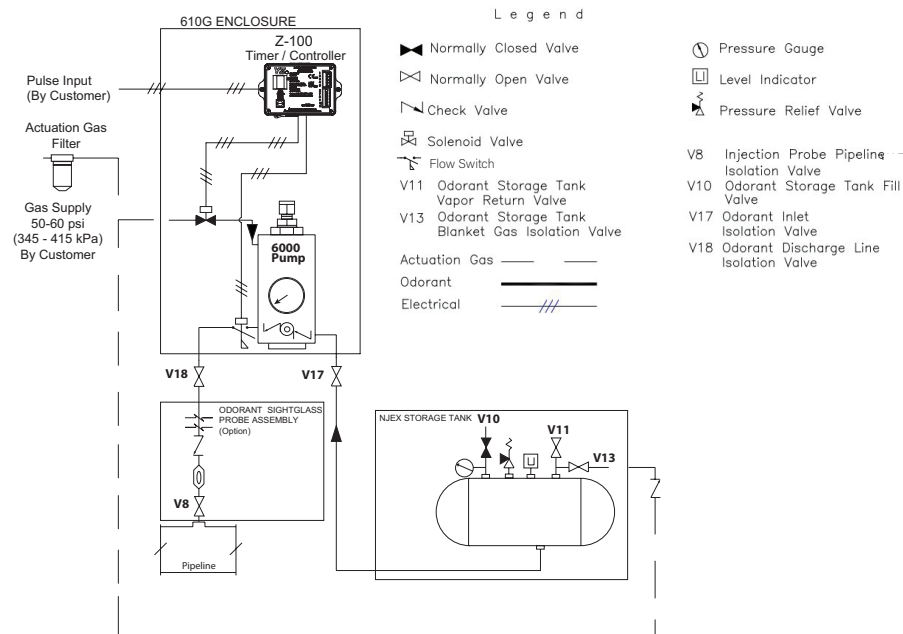

SECTION 4: SYSTEM CONTROL & ELECTRONICS

Overview

The electronic control package provided with your 610G / 610F odorizing system consists of Z-100 controller powered by an internal battery or external power supply and a low power solenoid. The Z-100 Controller will control the timing of the 6000B Pump based on the controller settings and mode of operation, either Prop to flow or time. When odorant is required, the controller will energize the solenoid, allowing the actuation gas to activate the 6000B Pump.

Figure 8

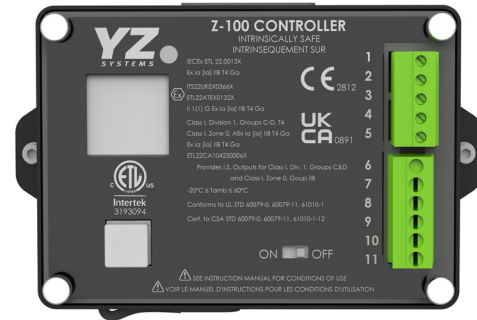

SAFETY NOTES:

Always take the necessary measures to verify whether the area has an explosive atmosphere and obtain necessary work permits are obtained and safety protocols followed. as required by the areas of installation.

Use the wiring label in the door of the NJEX LVO, also shown to the right, to make your connections to the Z-100 controller. Please note some connections may share a common Ground connection.

All wiring connected to the Z-100 controller must be done in accordance with the Wiring Control Document, see [Figure 20](#). The Z-100 rated for use in Class I, Division 1, Groups C&D and IECEx/ATEX Zone 0 hazardous locations.

WARNING:

- Electrostatic Discharge Hazard – Wipe with a damp cloth only.
- System is top-heavy. Lift cabinet with rigging to support weight and prevent it from tipping.
- The Z-100 controller is in a housing with more than 10% aluminum. Non-sparking tools must be used while servicing the Z-100 controller to avoid an ignition hazard due to impact or friction.
- Customer to ensure inlet actuation supply pressure does not exceed 90 psi (6.2 bar).

Z-100 Controller Approvals:

IECEX ETL 22.0013X
Ex ia [Ia] IIB T4 Ga

ITS22UKEX0366X
ETL22ATEX0132X
II 1(1) G Ex ia [Ia] IIB T4 Ga

Class I, Division 1, Groups C-D, T4
Class I, Zone 0, AEx ia [Ia] IIB T4 Ga
Ex ia [Ia] IIB T4 Ga

ETL22CA104230006X
Provides I.S. Outputs for Class I, Div. 1, Groups C&D
and Class I, Zone 0, Goup IIB

-20°C ≤ Tamb ≤ 60°C
Conforms to UL STD 60079-0, 60079-11, 61010-1
Cert. to CSA STD 60079-0, 60079-11, 61010-1-12

CE 2812
UK CA 0891

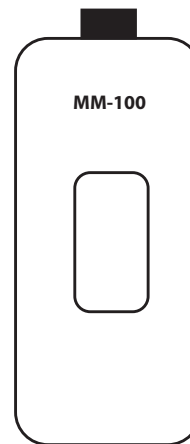

- RELAY + 1
- RELAY - 2
- ANALOG IN 3
- COMMON 4
- FLOW SWITCH 5
- EXT, POWER 6
- COMMON 7
- NBS IN 8
- COUNT IN 9
- SOLENOID - 10
- SOLENOID + 11

See below table for I/O signal and connection details:

Relay out	Term. 1(+), Term. 2(-)	Voltage free contact, solid state Recommended operating load 2ma max
Analog in	Term. 3(+) Term. 4/7(-)	Passive 4-20ma nominal 250ohm load
Flow switch	Term. 5(+) Term. 4/7(-)	Voltage free contact
NBS in / Inhibit in	Term. 8(+) to Term 4/7(-)	Voltage free contact or DC voltage 3.2v-24v
Count In	Term. 9(+) to Term. 4/7(-)	Voltage free contact (recommended), DC voltage pulse 5-24VDC 20ms minimum pulse width

SECTION 5: PROGRAMMING THE Z-100 CONTROLLER

Controller Overview:

Figure 9



To begin initial setup of the Z-100 Controller, move the Power switch, located on the front panel, to the ON position. The YZ logo will be shown while the controller is initializing then the Home Screen will be displayed when ready to operate.

The navigation switch has 5 functions: UP, DOWN, RIGHT, LEFT, and ENTER (center press). Pressing the switch in the appropriate direction to move between menus, and a center key to select sub menus or to modify, select, and save settings.

When moving between screens arrows will be shown on the display indicating what keys are active and their functions. Example illustration: the small down arrow indicates pressing the down key will allow you to scroll to additional Home Screen information. The right arrow next to "Menu" indicates pressing the right arrow will take you to the "Menu" Screen. See detailed navigation switch functionality in [Section 05](#), menu screens.

When the controller starts, the YZ Systems logo will load and the Home Screen will be displayed. The navigation switch will be used to navigate menus, change parameters, enter changes, etc. To navigate the controller, you will press the navigation switch in the direction you would like to move.

To open sub-menus, enter parameters, etc. you will use the navigation like a push button and push by pressing in the center of the switch.

When viewing a screen, note if there is an arrow at the top or bottom of the screen. If a small arrow is shown, it indicates you can scroll down or navigate in that direction. On some screens, additional instructions may be shown in the bottom corners.

The Z-100 controller has three main operating modes:

TIMER: In timer mode, the controller actuates the pump at a set time interval. The time interval can be set to 0.1 min to 180.00 min. in 0.01min. increments.

COUNTER: In counter mode, the Z-100 controller functions as a pulse divider. The controller monitors and counts incoming pulses at the count input. When the number of pulses equals the pulse divider setting the controller operates the pump. The pulse divider can be set from 1 to 10,000 in increments of 1.

ANALOG: In Analog mode, the Z-100 controller monitors a 4-20mA signal and operates the pump at a rate proportional to the 4-20mA signal as configured in the proportional to flow settings. See [Section 5](#), Analog mode.

Home Screen:

The daily totals are displayed on the Home Screen. The values are reset at midnight each day. Where the display shows DAILY TOTALS, this line will alternate between showing DAILY TOTALS and the running mode. It will display TIMER or COUNTER or ANALOG followed by OFF or ON.

Active alarms are shown. When an alarm is present, it will be prefixed with a number (#) indicating the total alarms present. The alarm text will cycle through the alarm list.

SECTION 5: PROGRAMMING THE Z-100 CONTROLLER

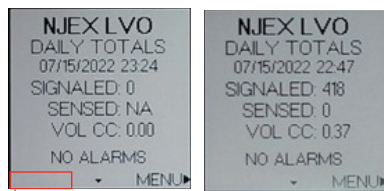

When the system is ON, a countdown to the next pump stroke is shown."

SIGNALLED: The daily count of how many times the controller actuated the 6000B pump.

SENSED: The sensed number of strokes is only displayed in a system with a flow switch (610F). If you have a system without a flow switch, "NA" will be displayed in the sensed total. For 610F systems, the sensed total counts the number of strokes confirmed by the flow switch.

VOL CC: For 610G systems, the daily CCs displayed on the Home Screen is a calculated value dependent on the signaled daily total. For 610F systems, the daily CCs displayed is a calculated value dependent on the sensed daily total.

MASS (LB/KG): Where VOL CC is displayed, it will alternate between the volume and the mass of odorant injected. For 610G systems, the daily mass displayed on the Home Screen is a calculated value dependent on the signaled daily total and the user input density. For 610F systems, the daily mass displayed is a calculated value dependent on the sensed daily total and the user entered density.

Additional Features:

- If multiple alarms are present, the alarm type will cycle on the home screen
- Hold switch up for approximately 1 second to trigger a single test pump stroke
- Hold the navigation switch left for approximately 1 second to start or stop system
- Bottom left has timer countdown to next pump stroke in counter mode a % of accumulated pulses is shown.

Totalizer:

From the Home Screen, you can navigate to the Totalizer by pressing down on the navigation switch. The totalizer is a running total of how much odorant has been pumped. The date the totalizer was started will be displayed at the top, along with the current date and time.

Identical to the daily total, the 610G will show NA for the sensed number of strokes. The screen will cycle between the volume, displayed in gallons or liters, and the mass, displayed in pounds or kilograms. The 610G will calculate these numbers based on the signaled stroke count while the 610F will calculate these numbers based on the sensed stroke count.

The totalizer can be reset by press enter on the navigation switch and hold until the value and date resets.

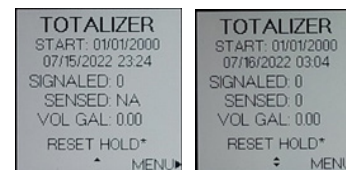

PUMP ALARM SCREEN (610F only): If your system has a flow switch from the home screen, the pump alarm screen can be accessed by pressing the navigation switch twice in the down direction. The pump alarm screen shows the number of strokes signaled (sent to the pump) and how many strokes were sensed (counted by the flow switch).

The pump alarm will be triggered If the difference between the signaled and sensed exceeds the DIFF setting. The DIFF, or number of missed strokes that will cause an alarm can be changed in the settings menu. The pump alarm screen will be reset at midnight each day, therefore the threshold of missed strokes must be surpassed that 24 hour period to cause an alarm.

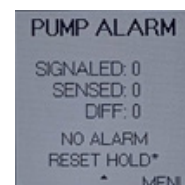

SECTION 5: PROGRAMMING THE Z-100 CONTROLLER

Using The Z-100 Controller:

The Z-100 user interface has been designed for easy navigation and setting of parameters.

The following sections outline the various screens and the steps needed to change and save settings.

Menu Screens:

To navigate to a Menu or Sub Menu screen, use the navigation switch and push up or down to highlight the desired option. The selected option will be highlighted with an asterisk to the left. To open that menu item and press the navigation switch. Note the instructions on the bottom row of the screen for additional information or how to navigate back to the previous screen.

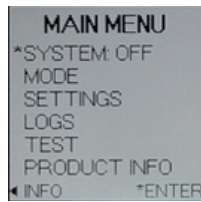

Modifying Controller Settings: Z-100 Controller settings will either be a value that must be changed, an item selected from a list, or a multiple-choice parameter option.

For items requiring a number to be edited, like the odorant density below, each digit will need to be changed individually. Note the arrow underneath the digit that is currently being edited. Press the left or right arrow to change which digit is updated. To change the value, press the navigation switch up or down. Move to the next digit as needed. To cancel the change, navigate to the back button and Press enter on the navigation switch to go back to the previous screen. To save the change, navigate to the Save option and Press enter on the navigation switch to save.

For an item that must be selected from a menu such as the pump spacer, the option that is currently selected will be shown with a dash next to it on the left. To change the selection, use the navigation switch and move up and down to the desired option. The possible selection will be shown with an asterisk to the left. Press the navigation switch to confirm the selected option.

Lastly, for the alarm sources, you can select multiple options to turn on or off each alarm source. The alarms will be shown with a dash next to it to indicate the alarm is active. The activate or deactivate an alarm, press the navigation switch up or down to the desired alarm source, the elected alarm will have an asterisk to the left. Press the navigation switch to enable or disable the alarm, if disabled the dash will be removed.

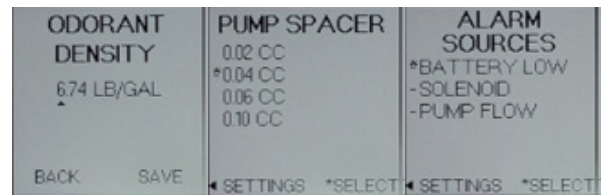

SECTION 5: PROGRAMMING THE Z-100 CONTROLLER

System ON/OFF:



This menu, is used to start and stop the system. Select ON to start odorizing as per the settings on the controller. Actuate the pump once immediately after turning the system ON and then begin odorizing as per the current operating mode and settings. Settings cannot be modified while the system is ON, If a settings change is attempted while the system is ON, the controller will display a popup notification prompting to STOP the system. Selecting Yes will turn the OFF and display the setting to be modified. Selecting No will leave the system ON and return to the previous menu.

The system must be re-started once settings changes are completed.

Selecting Z-100 Operational Mode:

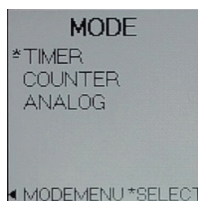

The Z-100 controller can operate your 610G/610F system in timer mode, counter mode, or analog mode. To select the Z-100 mode of operation, navigate to the Main Menu and select Mode. The Mode Menu will open showing the currently selected operating mode and mode specific settings.

Select Mode to access the list of modes available and * indicates the currently selected mode.

Once a mode has been selected, press the left key to exit back to the Mode Menu.

Timer Mode:

In timer mode, the controller actuates the 6000B pump at a set time interval as per the CYCLE TIME setting. The CYCLE TIME range is 0.1 minutes to 180.00 minutes in 0.01 minute increments.

To modify the CYCLE TIME, move the * to CYCLE TIME and press enter to select.

Use the navigation switch to modify the value then navigate to SAVE and press enter.

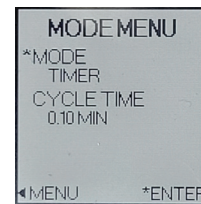

Counter Mode:

In counter mode, the Z-100 controller functions as a pulse divider. The controller monitors and counts a customer provided pulse signal at the COUNT input. When the number of pulses counted equals the PULSE DIVIDER setting the controller actuates the 6000B pump. The PULSE DIVIDER can be set from 1 to 10,000 in increments of 1. When the counter mode is selected, the PULSE DIVIDER setting will determine the pumps injection rate in response to the incoming pulses. For example, a pulse divider of 10 will cause the pump to actuate once each time 10 pulses are counted. The minimum pulse width is 20ms with a maximum input frequency of 25Hz. The pulse types available are Voltage or Dry Contact/SSR. Navigate to the Pulse Type option submenu. Select the pulse type and navigate to the select button and press enter to save.

Pulse Types:

Voltage: Positive voltage pulse (5-24VDC).

Dry/SSR: Voltage free contact closures.

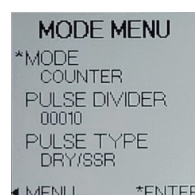

SECTION 5: PROGRAMMING THE Z-100 CONTROLLER

Analog Mode:

In Analog Mode the Z-100 controller monitors a 4-20mA flow signal provided by the customer. In this mode, the Z-100 controller monitors the incoming flow signal and with the INJECTION RATE and MAX FLOW settings calculates and varies the pump cycle time as needed to maintain a consistent odorization rate.

Analog mode settings include: INJECTION RATE, MAX FLOW. The Z-100 has a default calibration for the Analog Input. To obtain the best performance and accuracy perform the ZERO and SPAN calibration procedures below using the actual flow signal is recommended.

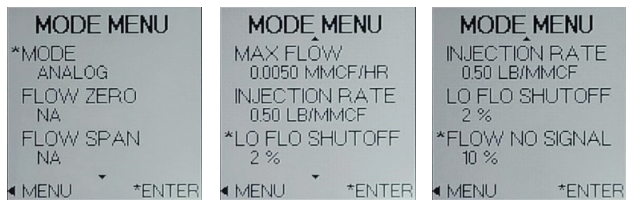

NOTE: The 4-20mA current signal is converted to a voltage prior to being displayed on the calibration screen.

Flow Zero: To begin setting parameters for Analog Mode, navigate to Main Menu->Mode->Flow Zero. Apply 4.0mA to the flow signal in TB(3) and TB(4) and press enter on the navigation switch to save the calibration. If successful, the voltage will read very close to 1.000V and the Flow Zero Screen will show CALIBRATED, indicating that a user calibration value is being used. If the flow signal is too far out of range, a RANGE ERROR message will be shown and there will be no change to the calibration state. The RESET function will clear the user calibration and return the unit to the factory calibrated values. Press the navigation switch to the left to return to the Mode Menu or navigate to Reset and press enter on the navigation switch in to cancel the calibration.

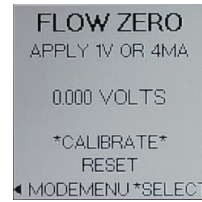

Flow Span: Apply 20.0mA to the flow signal in TB(3) and TB(4) and Press enter on the navigation switch to start calibration. If successful, the voltage will read very close to 5.00V and the Flow Zero Screen will show CALIBRATED, indicating that a user calibration value is being used. If the flow signal is too far out of range, a RANGE ERROR message will be shown and there will be no change to the calibration state. The RESET function will clear the user calibration and return the unit to the factory calibrated values. Press the navigation switch to the left to return to the Mode Menu or navigate to Reset and press enter on the navigation switch to cancel the calibration.

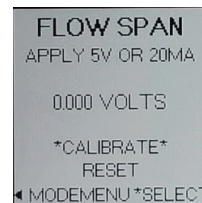

Max Flow: This value correlates to a 20ma signal on the analog flow input. The value can range from 0.0010MMCF/HR to 5.0000MMCF/HR.

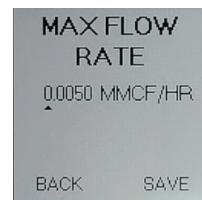

SECTION 5: PROGRAMMING THE Z-100 CONTROLLER

Injection Rate: To run the 610G/610F system proportional to the flow signal, you must enter an injection rate. Navigate to Main Menu->Mode->Injection Rate. Range from 0.10 LB/MMCF to 5.00LB/MMCF. The max stroke rate possible is 6sec/stroke. Caution: There is no warning given if the settings can possibly try to exceed this pump speed and the controller will effectively cap the speed of the pump to 6sec/stroke in these cases.

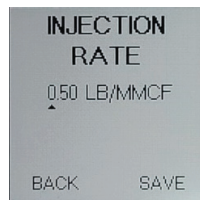

Low Flow : The low flow shutoff setting determines the percentage of the max gas flow the 610G/F system will enter standby in low flow conditions. While in standby the pump will not be actuated but the Z-100 will continue to monitor the inputs and report system status.

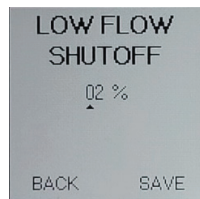

Flow No Signal: The Flow No Signal setting determines the percentage of max gas flow the 610G/F system will assume as the current pipeline flow when a valid flow signal is no longer present. A flow signal below 3.5mA is considered a loss of flow signal.

If the Flow No Signal setting is less than the Low Flow Shutoff setting, Flow No signal operation will take priority.

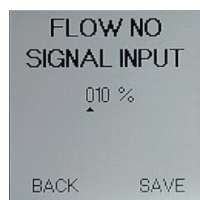

Changing Z-100 Settings:

In order to operate the 610G / 610F system to the proper odorization rate, the settings must be entered using the settings menu.

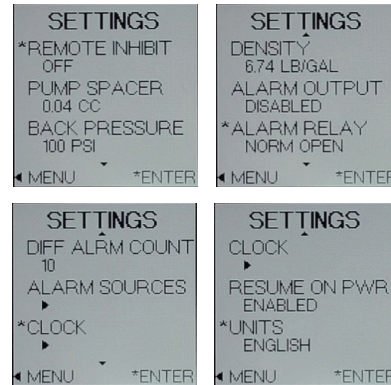

Remote Inhibit: The Remote Inhibit setting determines the functionality of the Remote inhibit/NBS input. To use this feature, set the REMOTE INHIBIT setting to ON. N.B.S (NJEX Backup System) setting can be used with an NJEX system. If this option is selected, it will put the unit in a standby mode when a signal from an NJEX system is wired to the NBS IN option on the controller and the signal is active. If the signal drops from this connection, the 610G / 610F system will run to the set parameters.

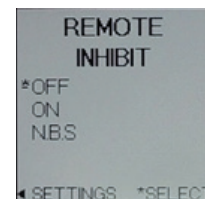

SECTION 5: PROGRAMMING THE Z-100 CONTROLLER

Pump Spacer:

The PUMP SPACER setting correlates to the pumps configured displacement. To reduce the pump capacity to less than 100%, a spacer is inserted into the pump (See [Section 5](#)). A metal tag listing 100%, 60%, 40%, or 20% is attached to the pump at the factory.

The value is in percentage of maximum rated capacity and is used in the totalized injection rate and volume calculations.

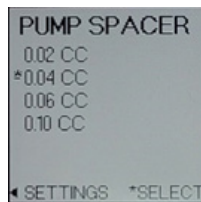

Back Pressure:

The 6000B pump output varies with back pressure. The BACK PRESSURE setting is used to improve the accuracy of odorant injected and odorization rate. The setting should match the nominal pipeline pressure during normal operation.

If pipeline pressures vary with seasonal changes, the BACK PRESSURE setting should be updated accordingly.

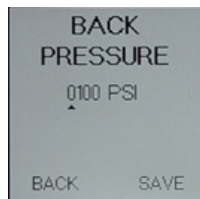

Density:

The ODORANT DENSITY setting is used in the calculations for estimating the mass odorant injected and odorization rate.

Enter the density provided in the odorant datasheet. NOTE: The Z-100 does not contain an ambient temperature sensor. Odorant density is typically specified at 60F. To improve accuracy, enter an odorant density for the average ambient operating temperature.

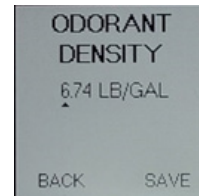

Relay Output:

The Z-100 provides a configurable dry contact relay output. NOTE: When powered from internal battery pack, enabling the Relay Output may reduce battery life. The Relay Output setting determines the outputs functionality and can be configured to DISABLE (lowest power setting), ALARM OUT, ODORANT OUTPUT.



Relay Function:

The RELAY FUNCTION setting determines the active state of the Relay Output when the selected event occurs. The options are NORM OPEN (Default) , or NORM CLOSED.

NOTE: NORM CLOSED should not be used in battery operated systems due to increase power consumption.

SECTION 5: PROGRAMMING THE Z-100 CONTROLLER

Diff Alarm Count:

This setting is only available on the 610F models (F indicates Flow Switch). The PUMP ALARM is triggered when the difference, DIFF, between pump actuations signaled and flow switch closures sensed exceeds the DIFF ALARM COUNT setting. The DIFF is accumulated over a 24 hour period and once exceeded will trigger the pump alarm. At the end the 24 hour period, the DIFF will reset to zero. Default is 10.



Alarm Sources:

Selecting Alarm Sources will open a sub-menu to select the alarm sources in which to be notified. The three alarm options are Battery Low, Solenoid, and Pump Flow (610F only). The selected alarm will be highlighted with an asterisk (*). Navigate to each alarm in the list and press enter on the navigation switch to select or deselect each option. If an alarm source is activated, it will have a single line dash (-) next to the alarm. Press the navigation switch left to exit the sub-menu.

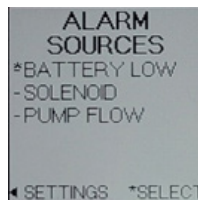

Battery Low:

The Battery Low alarm is an indication the battery voltage is low and should be replaced. If enabled, the Relay Output will be activated. The remaining battery capacity is dependent on the settings and ambient temperature the system is installed. The more often the pump is actuated with ambient temperatures approaching minimum or maximums of the operating range will result in considerably shorter battery capacity.

Solenoid:

The solenoid alarm is an indication the solenoid fuse (F1), needs to be replaced.

A low supply voltage could also cause a solenoid alarm. If replacing fuse (F1) does not remove the solenoid alarm, verify supply voltage is within the required operating range using the Battery Test function.

NOTE: The battery test function can also be used to verify external supply voltage.

If these steps do not remove the solenoid alarm, please contact YZ System Tech Support for help.

Pump Alarm:

The PUMP alarm is triggered when the difference, DIFF, between pump actuations signaled and flow switch closures sensed exceeds the DIFF ALARM COUNT setting in a 24 hour period.

SECTION 5: PROGRAMMING THE Z-100 CONTROLLER

Clock Menu:

Use the Clock Menu to configure the date and time settings. Having the correct time and date is important for the accuracy of Z-100 event logs and daily odorant usage estimates (DOU).

The time can be formatted as a 12- or 24-hour clock. The date can be formatted three ways (YYYY/MM/DD, DD/MM/YYYY, or MM/DD/YYYY). To set the CLOCK, move * to SET TIME and press enter on the navigation switch. The TIME SET will open. Press RIGHT and LEFT on the navigation switch to move to each editable setting, and UP and DOWN to modify each setting. Press RIGHT to move to the next setting or to move to BACK or SAVE.

To change the date formatting, move * to DATE FMT and press enter. Select the desired formatting and press enter to select.

When changes are complete press the left key to exit to the CLOCK menu.

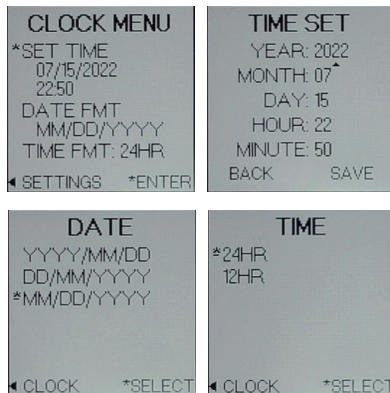

Resume On Power Loss:

If the 610G/610F system loses power during normal operation, the Resume on Power loss function can be enabled to allow the system to resume odorizing when power is restored. system is OFF when power is lost, it will remain OFF when power is restored. To enable, open the Resume on Power Loss sub-menu. Press navigation switch up or down and press enter to select an option. Press navigation switch left to exit the sub-menu.

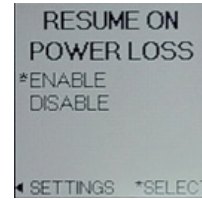

Units:

The Z-100 can be assigned either English or Metric units. Navigate to the Units sub-menu and press navigation switch up or down for available options and enter to *SELECT.

Press navigation switch left to exit the sub-menu.



Logs:

The Z-100 logs the odorant usage, parameter changes, alarms, and other events to the 610G/F system locally. The data can be downloaded with an MM-100 Memory Module, or viewed directly on the controller. To view the logged data, from the Main Menu scroll to the Logs option and press enter on the navigation switch to open.

Dou Logs:

The Daily Odorant Usage (DOU) logs are the daily odorant usage logs. Select the DOU option by pressing enter on the navigation switch. This will open the latest DOU log. The mass of odorant injected that day will be displayed along with the number of pump strokes signaled (610G & 610F) and sensed (610F only). Note the small arrows displayed on the bottom and/or top of each DOU screen indicate additional log data prior to or after is available to view. Scroll up or down to view logs from other days.

SECTION 5: PROGRAMMING THE Z-100 CONTROLLER

Config Logs:

The config logs contain a summary listing with event date and time of system setting change events. The CONFIG log does not include the details for a change. To view detailed information for each change event, the MODZ file from the controller must first be downloaded to an MM-100 memory module. Then the MM-100 downloaded to a PC using the MM-100 Download Utility.

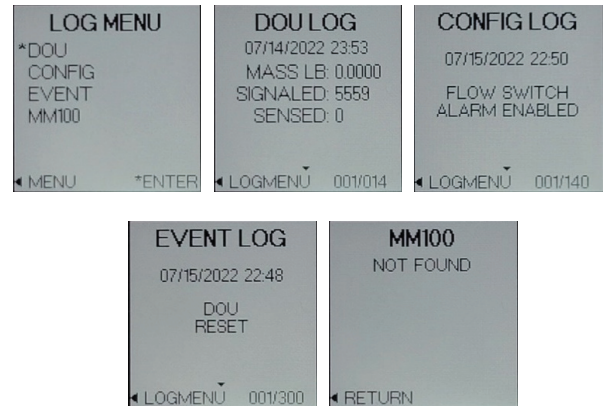

Event Logs:

Events, as they occur, are logged in the Z-100 Controller. These events include: System Start and Stop, Totalizer resets, DOU resets, Alarm Count resets, Power On, Alarm activity, Relay Output activity, Pump Test and Date/Time changes.

Test:

The test screen allows you to test the system functionality after installation or maintenance to ensure it is running as expected. Navigate from the Main Menu ->Test for the test screen.

MM100:

When ready to download the Z-100 logged data, remove the rubber plug located in the opening on the bottom of the Z-100 enclosure, and insert the MM-100 memory module onto the download connector. When the MM is inserted and detected by the controller, the download screen will automatically be displayed. You can also navigate to the screen through the menus. Please replace the protective rubber plug when download connector is not in use. If the MM-100 is not plugged in or not recognized, the MM100 screen will display "Not Found". If MM-100 is plugged in and recognized, you can download the module from the MM-100 screen.

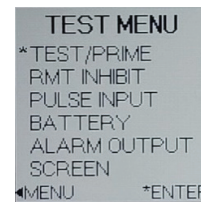

Remove the MM after download complete. The added current draw can impact battery life.

SECTION 5: PROGRAMMING THE Z-100 CONTROLLER

TEST / PRIME: The Test/Prime screen provides access to two functions.

Function 1, press enter on the navigation switch the UP direction for 1 to 2 seconds will actuate the solenoid a single time to stroke the 6000B pump.

Function 2, pressing the center button will initiate a prime cycle. The Prime cycle actuates the pump at a 2.5second cycle time for 60 cycles, or until stopped by pressing the center button.

The pump actuations signaled will increment each time the pump is stroked. For 610G systems "SENSED" will always show N/A. This allows the system to be primed during installation and maintenance.

When running the system in the Test/Prime mode in a 610F model, the "SENSED" value should increment when the discharge line is fully liquid packed, and equals the discharge or pipeline pressure.

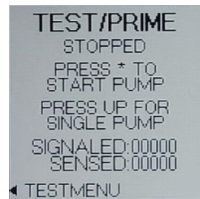

RMT INHIBIT: The INHIBIT TEST can be used to verify the incoming remote inhibit signal is being properly read by the Z-100 controller at the NBS IN (Remote Inhibit) input terminal.

If the REMOTE INHIBIT input setting is OFF, the test function will be disabled and TEST status NA displayed. Go to the SETTINGS MENU to change the REMOTE INHIBIT input setting.

If the REMOTE INHIBIT input setting is ON or NBS, upon entry, the INHIBIT TEST screen will show the INHIBIT test type (INHIBIT ON, or INHIBIT NBS) with NOT TESTING status. Press enter on the navigation switch to start the test and begin monitoring the NBS IN input.

If an active input signal is not sensed, the red LED will flash and the test status will indicate INPUT INACTIVE. If an active input signal is sensed the GREEN LED flash and the test status will indicate INPUT ACTIVE.

The difference between INHIBIT input types INHIBIT ON and NBS is the "active" voltage level of the incoming signal.

To stop the INHIBIT INPUT test press enter on the navigation switch.



PULSE TEST: The PULSE TEST can be used to verify the incoming pulsed flow signal is being properly read by the Z-100 controller at the COUNT input. The PULSE TEST signal will be interpreted based on the PULSE TYPE setting for COUNTER mode. To test the pulse signal, ensure the type of pulse is selected from the Mode Menu when the Counter mode is selected. The pulse types are voltage, or dry contact/SSR.

Navigate to the Pulse Input option from the Test Menu screen and press enter on the navigation switch to select. The Pulse Test screen will display what pulse type is selected. Press enter on the navigation switch to enter and start reading the pulse input. Send the pulse signal from the signal generator and confirm the counts on the Z-100 controller. The count will increase and the green LED will flash on every successful pulse reading.

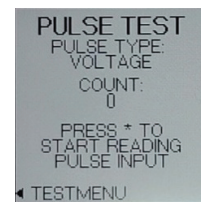

SECTION 5: PROGRAMMING THE Z-100 CONTROLLER

BATTERY TEST: The BATTERY TEST is used to verify the system power supply voltage read by the controller. The test is primarily used when to verify the voltage when the system is powered from the internal battery pack. The test can also be used to verify the voltage reading when the system is supplied by an external power source.

Select BATTERY TEST from the Test Menu and press enter on the navigation switch. The BATTERY TEST screen will open. The value shown initially will be from the previously run test and not a current reading. In order to get a valid test result, a solenoid must be connected to the system. Press enter to start the test, the solenoid will be actuated one time, the LED will flash and the battery voltage reading will be updated. A new battery will read approximately 11.5V during this test and the LED will flash GREEN. If the battery voltage is found to be low during the test, the LED will flash RED.

A fully charged new battery pack will measure approximately 14.4V if measured with a DMM or voltmeter at the battery leads.

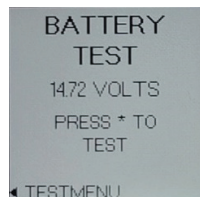

Relay Output Test:

The RELAY OUTPUT test is used to verify the RELAY OUTPUT is being properly sensed by the user's external SCADA or other control system.

If the RELAY OUTPUT setting is DISABLE, the test screen will indicate RELAY OUTPUT NOT CONFIGURED, CHECK SETUP. Change the RELAY OUTPUT setting to enable the output and test. If RELAY OUTPUT setting is ALARM OUT, the test display will show the relay config as ALARM OUT, the normal contact state, and ALARM OFF. Press enter to toggle the alarm ON or OFF and OPEN or CLOSE the output relay.

If RELAY OUTPUT setting is ODORANT PULSE, the test display will show the relay config as ODORANT PULSE, and normal output state. Press enter to initiate a single 40mS output pulse. The LED will flash GREEN to indicate the pulse was generated.

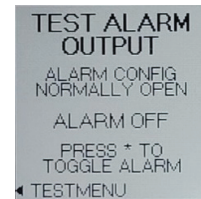

Screen Test:

The Screen Test will cycle all pixels on the display on (black), then all off (blank), then back to the Test Screen. This test can help determine if any pixels are malfunctioning on the display.

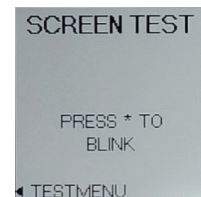

SECTION 6: PROGRAMMING FOR PROPORTIONAL-TO-TIME OPERATION

Setting Operator Input Parameters: Z-100 Controller Setup, Timer Mode

Figure 10

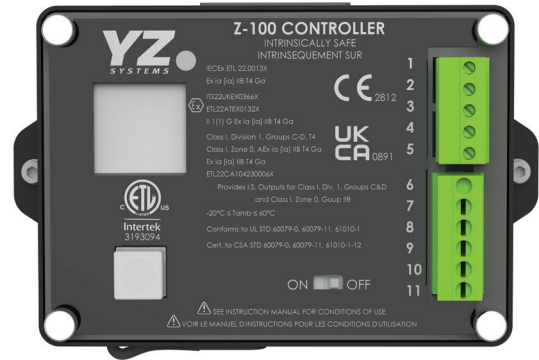

The rate at which the solenoid output is activated is controlled by the Cycle Time setting. Use the chart below to calculate the timer setting needed.

1. Pump displacement (from .02 to .1 cc)	=	a
2. Odorant density (lb/gal or g/cc)	=	b
3. Desired injection rate (lb/MMCF or mg/m ³)	=	c
4. Average flow rate (MCF/hr or m ³ /hr)	=	d
5. Timer setting		
a. English	=	$\frac{a \times b \times 15.8503^*}{c \times d}$
a. Metric	=	$\frac{a \times b \times 60000^*}{c \times d}$

		Example #1 English Gas Flow	Example #2 Metric Gas Flow
Pump displacement	(a) =	.05 cc	.05 cc
Odorant density	(b) =	6.80 lb/gal	.815 g/cc
Injection rate	(c) =	.5 lb/MMCF	8 mg/m ³
Flow rate	(d) =	6.00 MCF/hr	170 m ³ /hr
Example #1 Time setting	=	$\frac{0.05\text{cc} \times 6.80 \text{ lb/gal} \times 15.8503^*}{.5 \text{ lb/MMCF} \times 6.00 \text{ MCF/hr}}$	= 1.80 minutes
Example #2 Timer setting	=	$\frac{0.05\text{cc} \times 0.815 \text{ g/cc} \times 60000^*}{8 \text{ mg/m}^3 \times 170 \text{ m}^3/\text{hr}}$	= 1.80 minutes

* conversion constant

NOTE: To obtain maximum battery life, choose the longest time interval and the largest pump displacement setting possible.

See [Section 9, Troubleshooting](#)

SECTION 7: MECHANICAL SYSTEM

Overview

The 610G / 610F mechanical system is composed of the mechanical/electrical enclosure. Individual components of the system are shown below and described in the following pages.

Figure 11

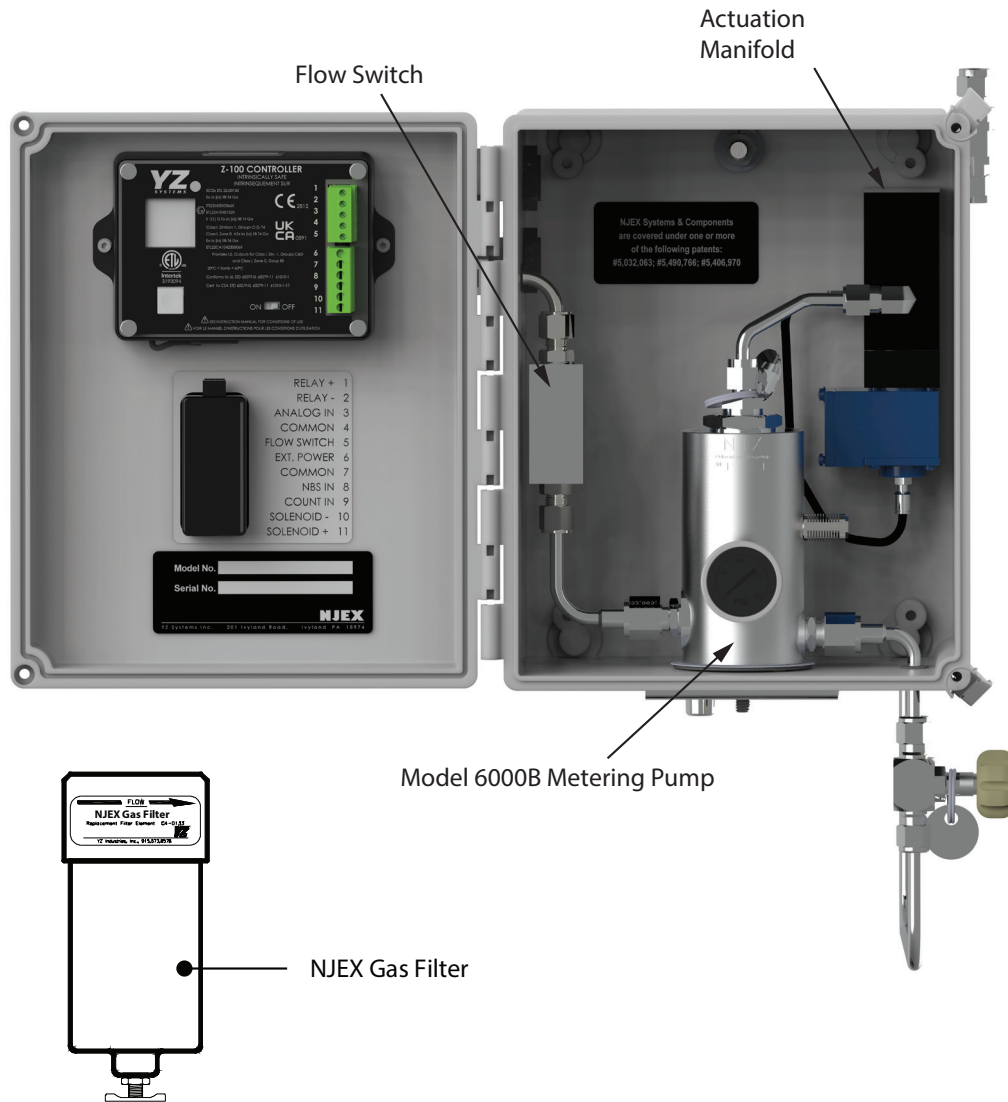

SECTION 7: MECHANICAL SYSTEM

NJEX LVO Gas Filter

Figure 12

A 25 micron coalescent filter is provided with each 610G / 610F. This filter, as shown, is installed on the back outside of the enclosure and should be connected to the regulated (30-60 psi / 2.1-4.1 bar, per [Table 1, Page 5](#)) actuation gas supply provided by the system operator. By conditioning the incoming actuation gas, a clean pneumatic supply will be provided to the solenoid valves. This will ensure a longer operational life for the pneumatic control system. If the actuation gas supply has a high water content and / or a low hydrocarbon dew point, additional filtration and heating of the actuation gas supply may be necessary. Bottled nitrogen can also be used as an alternate gas supply source if gas conditioning is a problem.



SECTION 7: MECHANICAL SYSTEM

Model 6000 Pump

Figure 13

The NJEX 6000 pump, as shown, is a pneumatically actuated, positive displacement, plunger pump. The 6000 is actuated with compressed air or pipeline gas at a pressure of 30-60 psi (2.1 – 4.1 Bar) - refer [Table 1, page 5, refer to Section 2, the System Flow Schematic, Figure 2](#). The pump has an adjustable displacement of 0.1cc to 0.02cc. It achieves proportional-to-flow injection through adjustment of the stroke rate. The 6000 is rated for a maximum stroke rate of 60 strokes per minute. Each time the pump strokes, the plunger displaces odorant through the discharge check valve. The pump is configured with two sets of plunger seals, segregated from each other with a trapped air space, minimizing the risk of odorant escape into the atmosphere.



The 6000 incorporates a cartridge design in key areas that may require maintenance.

They are: the inlet check valve, the discharge check valve, and the plunger bushing / seal assembly. The cartridge design provides easier maintenance resulting in less down-time.

The gauge on the front of the pump reflects any pressure between the two sets of seals in the pump in case of primary seal failure. Normally this gage should be reading “0 psi” and should show no movement. If the gage shows a sudden swing upward in pressure with each stroke of the pump, this is an indication that the pump should be rebuilt due to primary seal damage.

Figure 14

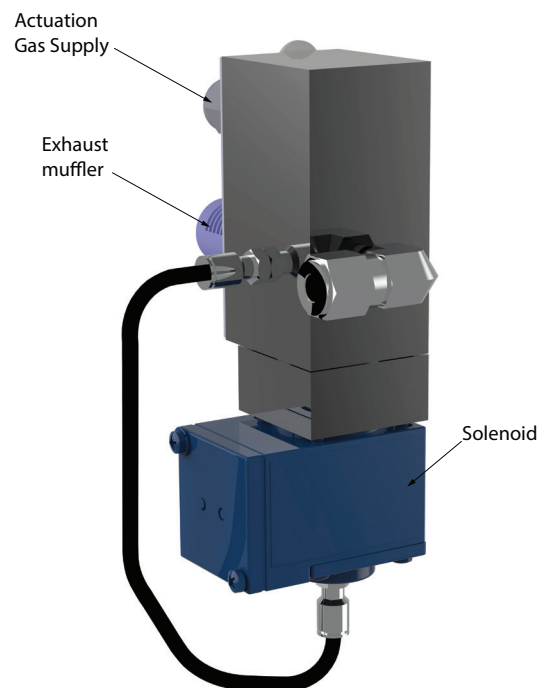

Actuation Gas Manifold:

The actuation gas manifold houses the actuation gas supply connection and the pneumatic exhaust connection for the 610G / 610F system. These openings are located on the back side of the mechanical enclosure and are ported through the enclosure wall. The upper manifold connection is for the actuation gas supply, while the lower connection is for the exhaust connection. The actuation gas manifold also serves as the mounting location for the solenoid valve.

SECTION 7: MECHANICAL SYSTEM

Flow Switch

Figure 15

The flow switch is installed in the discharge line of the flow switch. When flow is pushed through the switch, a magnetic contact will connect and send a signal to the controller.

The flow switch will come set at the factory, but may need to be adjusted for the installation site.

To adjust the flow switch, loosen the set screw (C) and move the reed switch contact (B) up or down and tighten the set screw.

On the home screen of the Z-100, press and hold the toggle switch up to trigger a test pump to check and repeat as necessary.

Please note during a new installation, the discharge lines must be packed with odorant, and the line up to back pressure before the flow switch will read.

The flow switch may need to be adjusted if the flow conditions change, such as back pressure, at the site of installation.

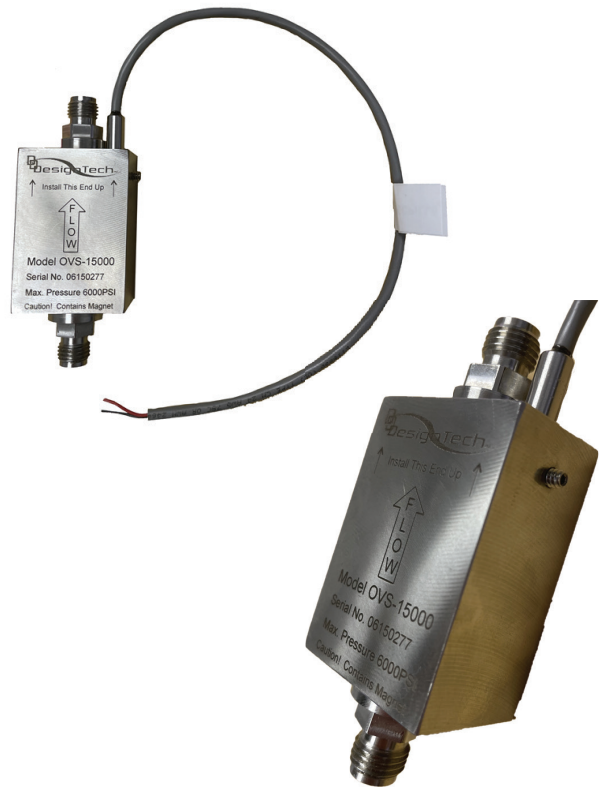

SECTION 8: SYSTEM MAINTENANCE

Preventative Maintenance Schedule

A preventative maintenance program serves to anticipate maintenance issues prior to waiting until the system requires service. Like changing the oil & filters in an automobile, by choosing to service the various parts and operation in the NJEX LVO System at regular intervals, the technician can perform the maintenance service when desired, rather than when required, such as in the middle of night.

The key is to perform maintenance before it is required. The preventive maintenance schedule implemented should consider the application of the odorizer. Many of these considerations include: the weather environment, the condition of, the actuation gas, the odorant and the odorant bulk storage tank, and the pump stroke frequency. All of these issues must be considered when establishing a preventative maintenance schedule.

Recommended Maintenance Schedule

Weekly Inspection

1. Verify gas pressures
2. Check for gas and odorant leaks
3. Visually inspect for obvious external problems

Semi-Annual Inspection

1. Inspect overflow protector and service as needed
2. Inspect tube fittings and valve packings for leaks.

Annual Inspection

1. Change filters
2. Rebuild pump
3. Replace solenoids

4. Test regulators and service, as needed
5. Condition the odorant, as needed
6. Test the NJEX LVO System performance.
7. Replace the battery (More frequent replacement may be required if the odorizer strokes more than 5 times per hour)

Recommended Spare Parts List

Part #	Description	Recommended Quantity
A4-0036	Replacement solenoid (no manifold)	1
C4-0133	NJEX LVO gas filter replacement filter element	1
D3-0140	Model 6000B pump seal replacement kit	1
D3-0284	Z-100 fuse replacement kit	1
E3-2005	LBP-14 internal Z-100 battery	1

Solenoid Maintenance

1. The solenoid assembly A4-0037 is made up of the solenoid A4-0036 and the manifold C1-0613. To replace the solenoid, remove only the two slotted head bolts as shown in figure. Removing any other screws to disassemble the solenoid voids the certification of the solenoid.

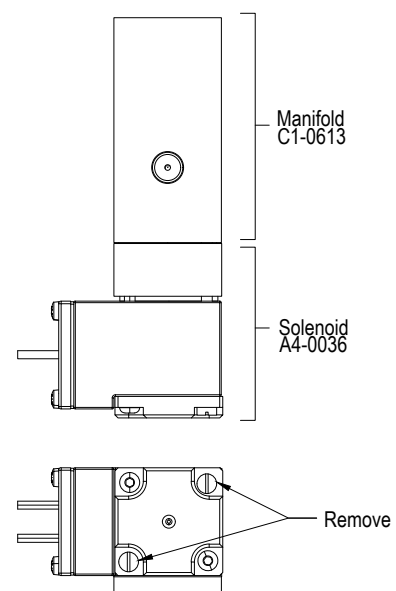

SECTION 9: 610G / 610F SYSTEM TROUBLESHOOTING

How to Use This Section

The recommendations contained in this section should be used as a preliminary information resource to remedy operational issues with the NJEX LVO System. It is important to read all of the definitions and notes prior to initiating work. Each sub-section contains a description of the alarm and non-alarm indicators followed by a step-by-step trouble shooting procedure

For Additional Help

Any issue that can not be resolved through the use of this reference, please contact YZ Technical Service at:

T: 1.800.653.9435

T: 1.281.362.6500, International Calls

E: techsupport@yzsystems.com

Assistance is available 24 hours a day, 7 days a week, 365 days a year, via the telephone numbers listed above

SAFETY NOTES

- Always use extreme care when performing maintenance on an odorization system. Check to ensure the removal of liquid odorant and pressure from the portion of the system on which work will be performed prior to removing components or fittings.
- Inspect all tube fittings and valve packings semi-annually to ensure that liquid odorant remains within the system.

Step-by-Step Resolution

Using a step-by-step method to resolve issues on the NJEX LVO System will reduce maintenance time and assist in returning the odorization system to service quicker.

The following represent the recommended chronology to resolve issues:

1. Re-establish the correct pressures
 - a. Bulk Storage Tank, 10 psi (0.7 Bar)
 - b. Actuation Supply, 30-60 psi (2.1 - 4.1 Bar), refer to [Table 1, Page 5](#).
2. Verify that the odorant storage tank has sufficient odorant in it to supply the NJEX LVO 610G / 610F with odorant.

SECTION 9: 610G / 610F SYSTEM TROUBLESHOOTING

Battery Power

The Z-100 controller and the low powered solenoid are normally powered by the Z-100 Battery assembly. The battery assembly is not a rechargeable type battery. Under normal conditions this battery may last two years. The Z-100 controller has an alarm that will advise when the battery needs replaced.

Battery Power Troubleshooting Steps:

- The battery voltage can be tested with the battery test option under the test menu. Navigate to the battery test menu and press enter on the navigation switch.
- While in the battery test menu, press the navigation switch in to test the battery.

Note: The battery test will send a signal to the solenoid to stroke the pump - the pump will stroke odorant into the discharge line if open. This provides the most accurate load on the battery pack to be representative of the available battery life.

- The battery voltage will be displayed on the screen and the LED will flash green or red, depending if the battery voltage is acceptable or low. It is recommended to replace the battery when it reaches 11.5 volts as shown on the controller in the battery test screen with the solenoid connected.

SECTION 9: 610G / 610F SYSTEM TROUBLESHOOTING

Troubleshooting: Pump Performance

1. Verify operating conditions. Correct as needed.
2. Check to see if the pump operation sounds the same as previously. A distinct bottoming of the plunger piston and a return to the top of the plunger piston housing should be audible with each actuation. If not, remove the actuation cylinder. Inspect for a broken return spring, or a stuck / sticking actuator piston or plunger. Replace the spring if broken. Clean and lubricate the actuation cylinder and actuation piston assembly. Manually push the plunger into the seal assembly and ensure it returns completely and freely. If sticking continues to occur, the seals should be replaced. Reassemble and see if alarm reoccurs after a system restart.
3. If pump actuation is normal:
 - a. Inspect the discharge lines and valves for a restriction.
 - b. Inspect all the check valves on the discharge side of the pump, from the NJEX LVO System to the pipeline, for proper operation.
 - c. Verify that the operating conditions remain unchanged and correct as needed.
4. Verify that the actuation pressure remains unchanged from previous setting.
5. Verify that all valves and check valves are properly set for system operation. Inspect for valve settings that can restrict pump displacement.
6. Check the actuation gas filter for flow restriction or closure.
7. Ascertain whether the pump is properly stroking.
 - a. If pump actuation does not occur as the test key is pressed, remove the actuation gas line at the top of the pump and test the pump stroke again. As the Test key is pressed, there should be a burst of gas at the open actuation supply connection. If the gas is released from the open actuation supply line skip to subsection 7.e., otherwise continue to 7.b.
 - b. If solenoid discharge to the pump connection does not release gas, remove the pump solenoid wiring cable. Next connect a multimeter to the connections 10 and 11 on the Z-100 controller. Press the test function on the Z-100 by pressing up on the navigation switch while on the home screen or by the test screen. Observe if an approximate 12VDC current becomes present. If a voltage is detected the solenoid should be replaced.
 - c. If the above test indicates the solenoid is functioning, next determine if the signal is being sent by the controller, or lost in the cabling and connections. Go to the Z-100 Controller terminal strip and connect your voltmeter, to terminals 10 and 11, with 11 being the positive wire and 10 being the negative wire. Now, test fire the pump with the test function on the Z-100 by pressing up on the navigation switch while on the home screen or by the test screen. A momentary voltage pulse, approximately 0.2 seconds in duration, should be observed. This will be a DC voltage pulse, approximately 12VDC. Varies based on battery or external supply voltage. If the pulse is at the termination strip, next check the polarity of connections of the wiring. Try reversing the terminal wiring connections for the terminals 10 and 11, and repeat steps 7a and 7b. If this does not correct the problem the cable assembly to the solenoid should be replaced.
 - d. If no voltage is detected, check the fuses on the circuit board using the label adhered to the potting as a guide. Replace fuses as necessary.

SECTION 9: 610G / 610F SYSTEM TROUBLESHOOTING

- e. With the actuation gas line reconnected to the pump, test stroke the pump. Observe if there is an audible pump stroke with the piston bottoming out and returning to the top of the pump housing. If an audible pump actuation is not present, remove the actuation cylinder and inspect for a broken return spring, or a stuck / sticking plunger assembly. Replace the spring if broken, clean and relubricate the plunger assembly and actuation cylinder. Make certain the seals are not sticking to the plunger assembly.
8. If problem persists, contact YZ technical service for additional assistance.

Troubleshooting: Flow Switch

1. Verify operating conditions. Correct as needed.
2. Check that the pump is operating as expected. If the pump is not stroking, see the pump troubleshooting section.
3. If the pump is functioning as expected, go to the Z-100 Controller terminal blocks and connect a volt meter to terminals 4 and 5 to test for continuity. Test fire the pump and the connection will close momentarily if the flow switch counted the pump stroke. If this does not read, check the setting of the flow switch next.
4. The flow switch will come set at the factory, but may need to be adjusted to measure the flow at the exact application site. To adjust the switch, use a hex key to turn the set screw located on the flow switch body. This will loosen the fit on the switch contact and the contact will drop in the body. Adjust the position of the contact and trigger another pump stroke. Repeat as necessary until the stroke is read by the controller. Tighten the set screw to set the position.
5. If the flow switch is still not reading, please contact YZ Technical Support for additional help.

APPENDIX A: ILLUSTRATIONS

NJEX LVO Model 6000B pump Assembled

Figure 16

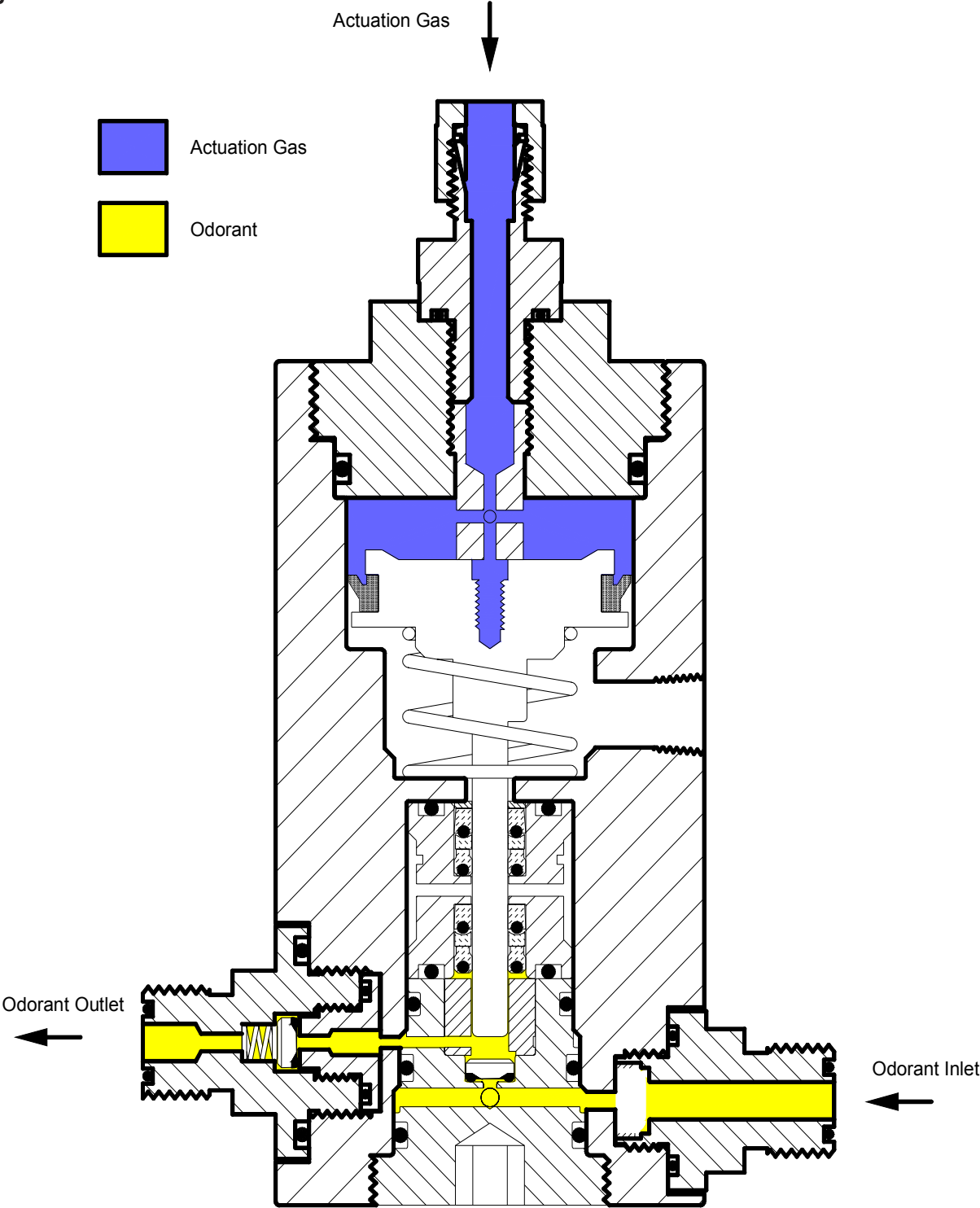

6000B Pump Repair Kit (P/N D3-0140)

APPENDIX A: ILLUSTRATIONS

Figure 17

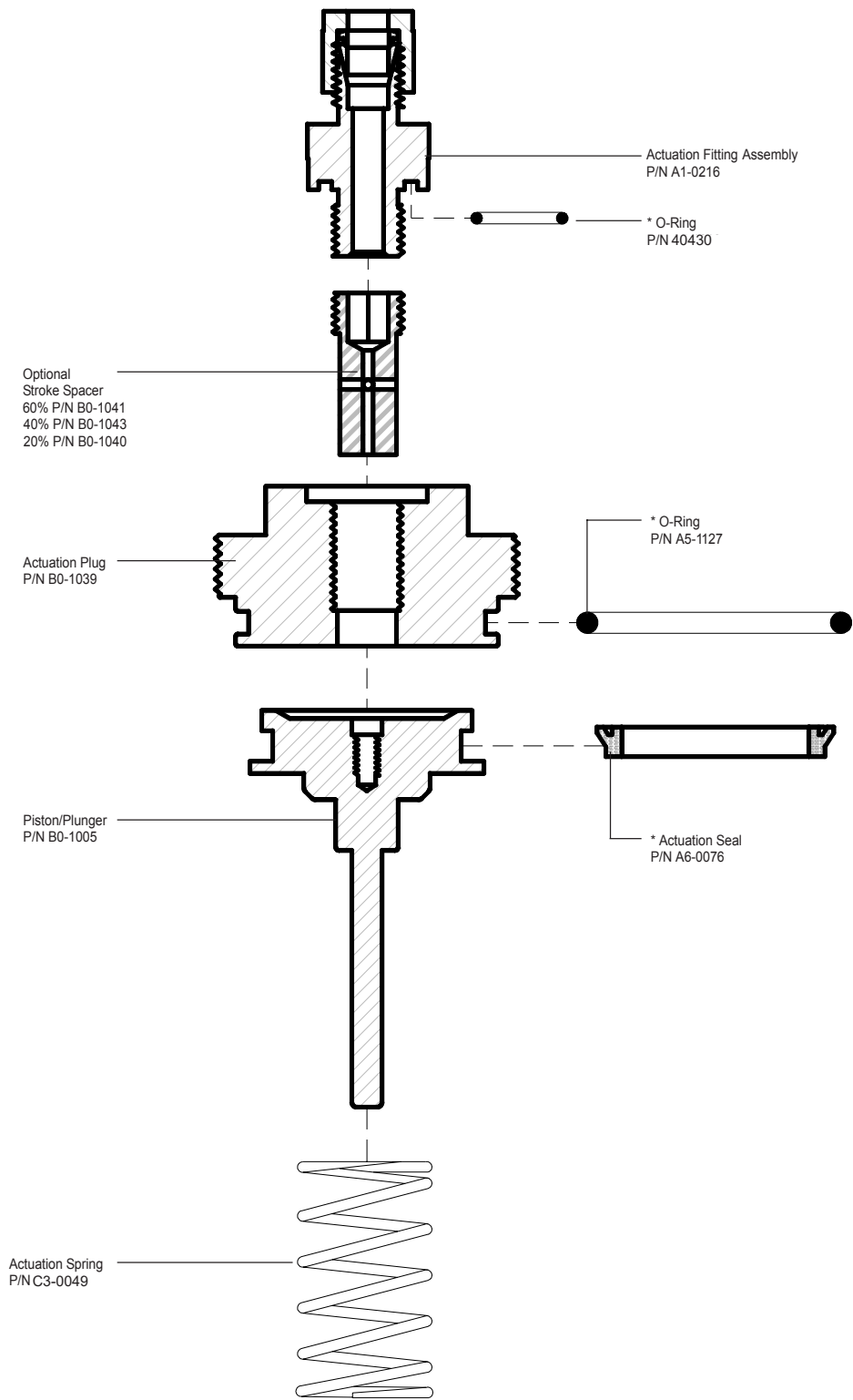

APPENDIX A: ILLUSTRATIONS

Figure 18

PLUNGER SEAL ASSEMBLY

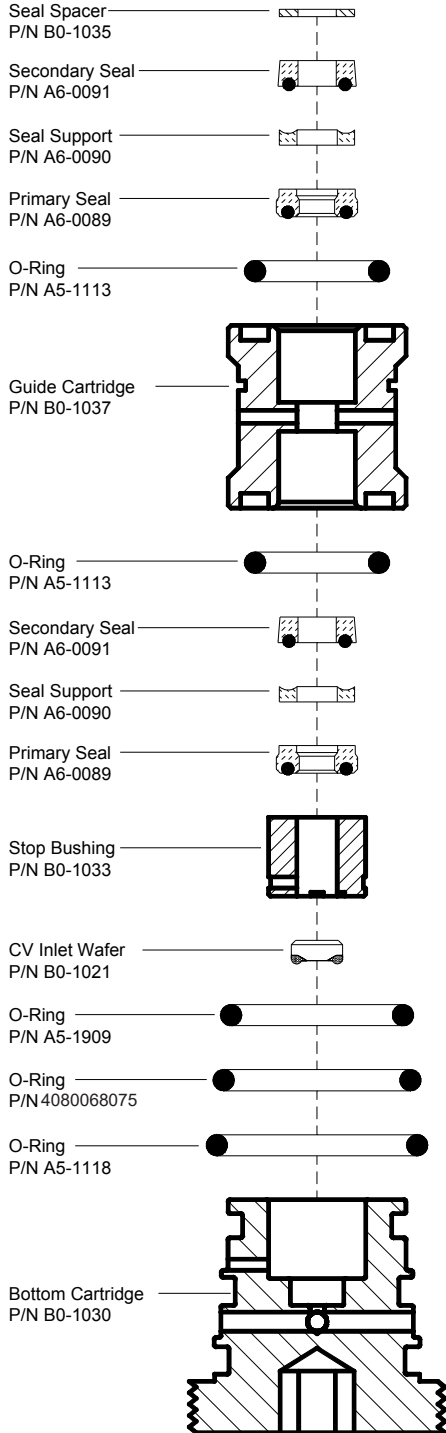

DISCHARGE CHECK ASSEMBLY

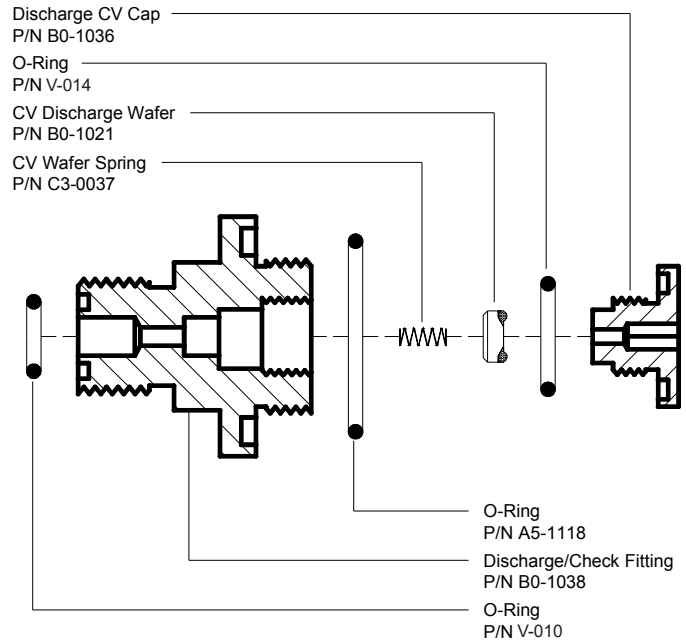

INLET ASSEMBLY

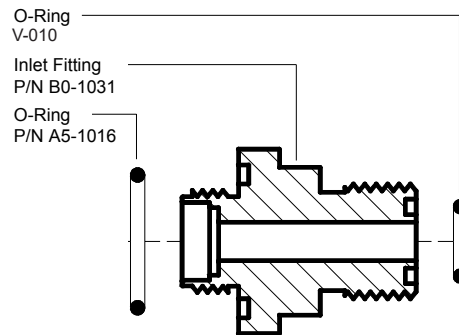

APPENDIX A: ILLUSTRATIONS

Figure 19

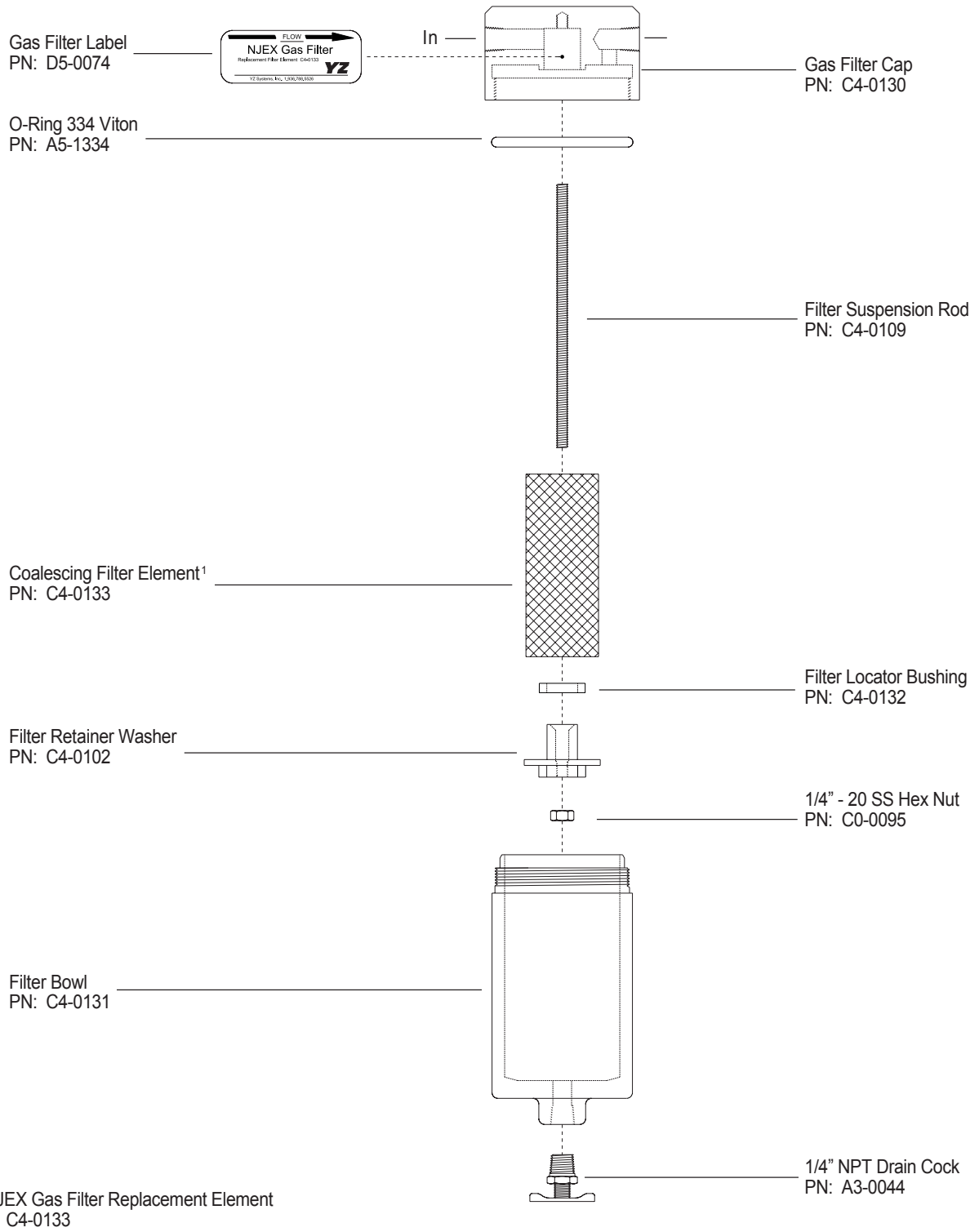

APPENDIX A: ILLUSTRATIONS

Figure 20



Z-100 ELECTRONIC CONTROLLER HAZARDOUS AREA INSTALLATION INSTRUCTIONS AND DRAWINGS

The following instructions apply to equipment covered by the following certificate numbers:

IECEX: IECEX ETL 22.0013X
ATEX: ETL22ATEX0132X
UKEX: ITS22UKEX0366X
NORTH AMERICA: ETL22CA104230006X

APPLICABLE STANDARDS:
Class I, II, and III, Division 1, Hazardous (Classified) Locations
UL 913:2013 Ed.8+R:06 Dec2019
UL 60079-0:2019 ED.7 + R:15 APR 2020, UL 60079-11:2013 ED.6 + R:14 SEP2018
CSA C22.2#60079-0 : 2019 ED.4, CSA C22.2#60079-11 : 2014 ED.2)(R2018)
IEC 60079-0 : 2017 ED.7, IEC 60079-11 : 2011 ED.6
EN 60079-0 : 2018, EN 60079-11 : 2012

The Z-100 controller assembly (F2-0615) is an intrinsically safe electronic controller that can reside in a hazardous area and is used to control and monitor chemical injection or sampling applications. The Z-100 also provides several entity rated intrinsically safe customer inputs and outputs. These include 2 digital inputs, 1 digital output, and 1 analog input for interfacing to suitably certified equipment located inside or outside the hazardous area.

The Z-100 Controller may be used in hazardous area locations with flammable gas and vapors of Class I group IIB Zone 0 or Division 1 Group C-D with a temperature class rating of T4 with an ambient temperature range of -20C to +60C.

Z-100 Intrinsically Safe Controller Assembly F2-0615, shall be housed in a general purpose enclosure with or without factory interconnect wiring and mechanical components. The minimum IP rating of the system enclosure shall be IP54.

For safe operation and installation the information in this document, and the end applications system level instruction and operating manual shall be observed.

The Z-100 Controller shall only be installed and maintained by qualified personnel in accordance with all local laws, national laws, directives, and standards applicable to the country and area of installation.
Factory wiring shall not be modified.

02/16/2023	28238	PRODUCTION RELEASE	GSS	YZT	00
12/14/2022	26682	PRELIM: UPDATED ENTITIES, ADDED WARNING,	GSS	YZT	C
DATE	ECN	DESCRIPTION	UPD BY	APR BY	REV

COPYRIGHT © MILTON ROY, LLC THIS DOCUMENT IS THE PROPERTY OF MILTON ROY (MR). YOU MAY NOT POSSESS, USE, COPY OR DISCLOSE THIS DOCUMENT OR ANY INFORMATION IN IT, FOR ANY PURPOSE, INCLUDING WITHOUT LIMITATION TO DESIGN, MANUFACTURE OR REPAIR PARTS, OR OBTAIN ANY GOVERNMENT APPROVAL TO DO SO, WITHOUT MR'S EXPRESS WRITTEN PERMISSION. NEITHER RECEIPT NOR POSSESSION OF THIS DOCUMENT ALONE, FROM ANY SOURCE, CONSTITUTES SUCH PERMISSION. POSSESSION, USE, COPYING OR DISCLOSURE BY ANYONE WITHOUT MR'S EXPRESS WRITTEN PERMISSION IS NOT AUTHORIZED AND MAY RESULT IN CRIMINAL AND/OR CIVIL LIABILITY.

UNLESS OTHERWISE SPECIFIED:
DIMENSIONS ARE INCH[mm]
INTERPRET DIM AND TOL
PER ASME Y14.5-2009

TOLERANCES:

.X	± .050[1.27]
.XX	± .010[.254]
.XXX	± .005[.127]
∠	± .5°
FRACTIONS	± 1/64[.397]
FINISH:	125√RMS

www.miltonroy-americas.com MILTON ROY, LLC

TITLE

INSTALLATION DRAWING YZ SYSTEMS Z-100 CONTROLLER

THIRD ANGLE PROJECTION	DO NOT SCALE DRAWING	SIZE A	DRAWING NO 2E-0042	REV 00
			SCALE 1 : 1	SHEET 1 of 4

EAR STATEMENT WARNING - This document or file contains technical data the export of which is, or may be, restricted by the Export Administration Act and the Export Administration Regulations (EAR), 15 C.F.R., parts 730-774. Diversion contrary to U.S. law is prohibited. The export, re-export, transfer or re-transfer of this technical data to any other company, entity, person, or destination, or for any use or purpose other than that for which the technical data was originally provided by Milton Roy, is prohibited without prior written approval from Milton Roy and authorization under applicable export control laws. EAR Export Classification: ECCN EAR99.



APPENDIX A: ILLUSTRATIONS



Z-100 ELECTRONIC CONTROLLER HAZARDOUS AREA INSTALLATION INSTRUCTIONS AND DRAWINGS

WARNING: Substitution of components may impair intrinsic safety.

AVERTISSEMENT: La substitution de composants peut compromettre la sécurité intrinsèque.

WARNING: Explosion Hazard - To prevent ignition of an explosion atmosphere remove power before disconnecting any equipment or wiring unless the area is known to be non-hazardous.

AVERTISSEMENT: Risque d'explosion - Pour éviter l'inflammation d'une atmosphère d'explosion, coupez l'alimentation avant de déconnecter tout équipement ou câblage, à moins que la zone ne soit connue pour être non dangereuse.

WARNING: Replace removable fuses with the same type and rating to provide protection against the risk of fire and shock.

AVERTISSEMENT: Remplacez les fusibles amovibles avec le même type et les mêmes caractéristiques pour vous protéger contre les risques d'incendie et de choc.

WARNING: If battery powered, use only YZ Systems replaceable battery pack assembly, Part Number: E3-2005

AVERTISSEMENT: Si alimenté par batterie, utilisez uniquement l'ensemble de batterie remplaçable YZ Systems, numéro de pièce : E3-2005.

WARNING: F2-0615 Z-100 Controller contains lithium primary battery (VBAT1) under encapsulation. Unit may explode if mistreated. Do Not Recharge, Disassemble or Dispose of in fire.

AVERTISSEMENT: Le contrôleur F2-0615 Z-100 contient une batterie primaire au lithium (VBAT1) sous encapsulation. L'appareil peut exploser s'il est maltraité. Ne pas recharger, démonter ou jeter au feu.

WARNING: POTENTIAL STATIC CHARGING HAZARD - To avoid static buildup, use a damp cloth to clean all painted or other non-metallic surfaces.

AVERTISSEMENT: RISQUE DE CHARGE STATIQUE POTENTIEL - Pour éviter l'accumulation d'électricité statique, utilisez un chiffon humide pour nettoyer toutes les surfaces peintes ou non métalliques.

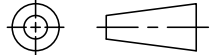
COPYRIGHT © MILTON ROY, LLC THIS DOCUMENT IS THE PROPERTY OF MILTON ROY (MR). YOU MAY NOT POSSESS, USE, COPY OR DISCLOSE THIS DOCUMENT OR ANY INFORMATION IN IT, FOR ANY PURPOSE, INCLUDING WITHOUT LIMITATION TO DESIGN, MANUFACTURE OR REPAIR PARTS, OR OBTAIN ANY GOVERNMENT APPROVAL TO DO SO, WITHOUT MR'S EXPRESS WRITTEN PERMISSION. NEITHER RECEIPT NOR POSSESSION OF THIS DOCUMENT ALONE, FROM ANY SOURCE, CONSTITUTES SUCH PERMISSION. POSSESSION, USE, COPYING OR DISCLOSURE BY ANYONE WITHOUT MR'S EXPRESS WRITTEN PERMISSION IS NOT AUTHORIZED AND MAY RESULT IN CRIMINAL AND/OR CIVIL LIABILITY.	UNLESS OTHERWISE SPECIFIED: DIMENSIONS ARE INCH[mm] INTERPRET DIM AND TOL PER ASME Y14.5-2009 TOLERANCES: .X ± .050[1.27] .XX ± .010[.254] .XXX ± .005[.127] ∠ ± .5° FRACTIONS ± 1/64[.397] FINISH: 125√RMS	 MILTON ROY www.miltonroy-americas.com MILTON ROY, LLC		
	THIRD ANGLE PROJECTION 		TITLE INSTALLATION DRAWING YZ SYSTEMS Z-100 CONTROLLER	
	DO NOT SCALE DRAWING	SIZE A	DRAWING NO 2E-0042	REV 00
			SCALE 1 : 1	SHEET 2 of 4

EAR STATEMENT WARNING - This document or file contains technical data the export of which is, or may be, restricted by the Export Administration Act and the Export Administration Regulations (EAR), 15 C.F.R., parts 730-774. Diversion contrary to U.S. law is prohibited. The export, re-export, transfer or re-transfer of this technical data to any other company, entity, person, or destination, or for any use or purpose other than that for which the technical data was originally provided by Milton Roy, is prohibited without prior written approval from Milton Roy and authorization under applicable export control laws.
EAR Export Classification: ECCN EAR99.



APPENDIX A: ILLUSTRATIONS



HAZARDOUS AREA INSTALLATION INSTRUCTIONS AND DRAWINGS

Conditions for safe use:

The system shall not be connected to any associated apparatus which uses or generates more than 250VRMS.

Installations:

- USA- Installations shall be in accordance with the National Electric Code (NEC), NFPA-70, and ANSI/ISA-RPI206.1
- Canada - Installation shall be in accordance with Canadian Electrical Code (CEC) Part 1 (CSA22.1).
- ATEX/IECEX - Installations shall be in accordance with all applicable local and national electrical codes, EN60079-14, IEC60079-25, and all Essential Health and Safety Regulations of Directive 2014/34/EU.

Z-100 Controller Assembly F2-0615 is rated and shall be marked as follows:

- Z-100 Controller
- Ex ia IIB T4 Ga
- II 1 G Ex ia IIB T4 Ga
- Class I, Zone 0, AEx ia IIB T4 Ga
- Class I Division 1, Groups C-D, T4

NOTES:

1. INTRINSICALLY SAFE INTERCONNECT WIRING BETWEEN DEVICES SHOWN MAY BE FACTORY INSTALLED.
2. SUBSTITUTION OF COMPONENTS COULD IMPAIR INTRINSIC SAFETY.
3. CABLE(S) X SHALL BE SHIELDED TWISTED PAIR TYPE. CABLE SHIELDS SHALL BE EARTHED PER 60079-14 IN NON-HAZARDOUS AREA.
4. WHEN USING MULTI-CORE TYPE CABLE(S) FOR CABLE X THE CABLE SHALL BE TYPE A OR B PER 60079-25 CLAUSE 9.
5. IF USING DIODE SAFETY BARRIERS, FOLLOW MANUFACTURERS INSTALLATION INSTRUCTIONS FOR PROPER SAFETY GROUNDING TO PROTECTIVE EARTH.
6. ANALOG FLOW INPUT (TB2) AND COUNT INPUT (TB2) SHALL NOT BE CONNECTED AT THE SAME TIME.
7. INTRINSIC SAFETY BARRIERS OR ISOLATORS SHALL BE COMPLIANT WITH THE SAFETY PARAMETERS LISTED FOR EACH INPUT OR OUTPUT.
8. THE AMBIENT TEMPERATURE RANGE FOR F2-0615 IS -20C TO +60C.
9. F2-0615 INTRINSIC SAFETY PROTECTION LEVEL IS: "ia".
10. EXTERNAL I.S. SUPPLY AND BATTERY PACK E3-2005 SHALL NOT BE CONNECTED AT THE SAME TIME.
11. REPLACEABLE INTRINSICALLY SAFE BATTERY PACK ASSEMBLY, E3-2005, CONTAINS LITHIUM PRIMARY CELLS. DO NOT STORE OR USE IN TEMPERATURES EXCEEDING 85C. DO NOT CHARGE, DISASSEMBLE, OR INCINERATE. DEPLETED BATTERY PACKS SHOULD BE DISPOSED OF PER LOCAL REGULATIONS.
12. ALTHOUGH RECOMMENDED TO VERIFY THE AREA IS SAFE, THE E3-2005 BATTERY PACK MAY BE REPLACED SAFELY IN A HAZARDOUS AREA. REPLACE **ONLY** WITH YZ PN: E3-2005 INTRINSICALLY SAFE BATTERY PACK ONLY, **SUBSTITUTION OF COMPONENTS MAY IMPAIR INTRINSIC SAFETY.**
13. MM-100 MEMORY MODULE ASSEMBLY F2-0268 IS NOT NORMALLY CONNECTED TO THE CONTROLLER. TO PREVENT POTENTIAL DAMAGE OR SYSTEM RESETS WHEN MEMORY MODULE IS NOT IN USE, COVER THE CONTROLLER CONNECTOR WITH PROVIDED SEAL. SHORT CIRCUITS OR ESD DISCHARGE TO TO THESE CONNECTIONS COULD RESET OR DAMAGE THE CONTROLLER.
14. Z-100 CONTROLLER IS INTENDED FOR FIXED INSTALLATION.
15. Z-100 CONTROLLER F2-0615 SHALL BE MOUNTED IN AN ENCLOSURE WITH A MINIMUM IP54 RATING IN SYSTEM LEVEL OR FINAL INSTALLATION.
16. MATERIAL USED IN Z-100 COVER PLATE IS ALUMINUM WHICH EXCEEDS 10% IN TOTAL. PLEASE SEE APPLICABLE SYSTEM LEVEL USER MANUAL FOR INSTRUCTIONS TO AVOID IGNITION HAZARD DUE TO IMPACT OR FRICTION.
17. **SCHEDULE DRAWING - DO NOT MODIFY WITHOUT AGENCY APPROVAL.**

COPYRIGHT © MILTON ROY, LLC THIS DOCUMENT IS THE PROPERTY OF MILTON ROY (MR). YOU MAY NOT POSSESS, USE, COPY OR DISCLOSE THIS DOCUMENT OR ANY INFORMATION IN IT, FOR ANY PURPOSE, INCLUDING WITHOUT LIMITATION TO DESIGN, MANUFACTURE OR REPAIR PARTS, OR OBTAIN ANY GOVERNMENT APPROVAL TO DO SO, WITHOUT MR'S EXPRESS WRITTEN PERMISSION. NEITHER RECEIPT NOR POSSESSION OF THIS DOCUMENT ALONE, FROM ANY SOURCE, CONSTITUTES SUCH PERMISSION. POSSESSION, USE, COPYING OR DISCLOSURE BY ANYONE WITHOUT MR'S EXPRESS WRITTEN PERMISSION IS NOT AUTHORIZED AND MAY RESULT IN CRIMINAL AND/OR CIVIL LIABILITY.

UNLESS OTHERWISE SPECIFIED:
DIMENSIONS ARE INCH[mm]
INTERPRET DIM AND TOL
PER ASME Y14.5-2009
TOLERANCES:

.X	± .050[1.27]
.XX	± .010[.254]
.XXX	± .005[.127]
∠	± .5°
FRACTIONS	± 1/64[.397]
FINISH:	125 √RMS

THIRD ANGLE PROJECTION

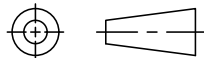

MILTON ROY
www.miltonroy-americas.com MILTON ROY, LLC

TITLE

INSTALLATION DRAWING
YZ SYSTEMS
Z-100 CONTROLLER

DO NOT
SCALE
DRAWING

SIZE
A

DRAWING NO

2E-0042

REV
00

SCALE

1 : 1

SHEET

3 of 4

EAR STATEMENT WARNING - This document or file contains technical data the export of which is, or may be, restricted by the Export Administration Act and the Export Administration Regulations (EAR), 15 C.F.R., parts 730-774. Diversion contrary to U.S. law is prohibited. The export, re-export, transfer or re-transfer of this technical data to any other company, entity, person, or destination, or for any use or purpose other than that for which the technical data was originally provided by Milton Roy, is prohibited without prior written approval from Milton Roy and authorization under applicable export control laws.
EAR Export Classification: ECCN EAR99.



APPENDIX A: ILLUSTRATIONS

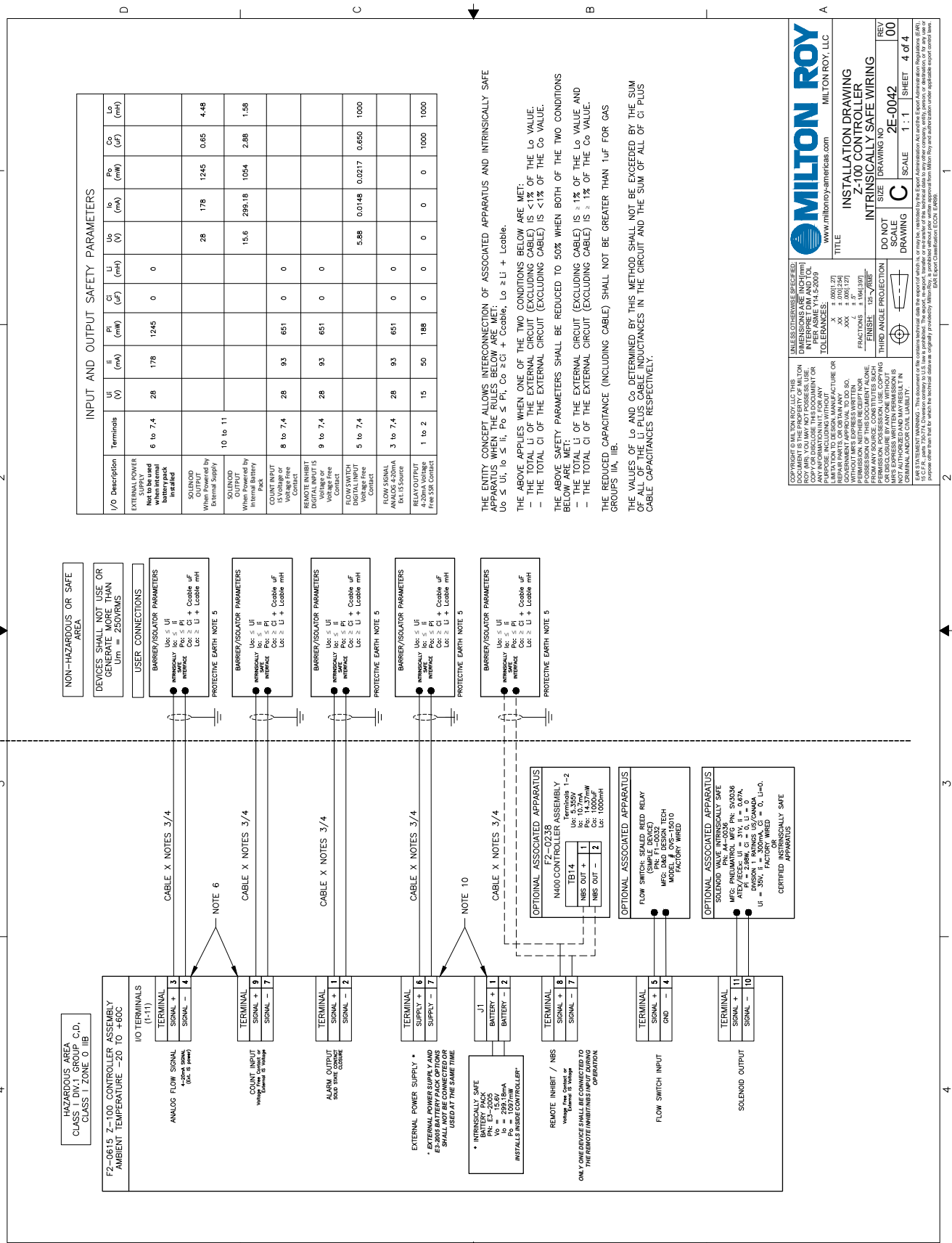

MILTON ROY
www.miltonroy-americas.com

INSTALLATION DRAWING
Z-100 CONTROLLER
INTRINSICALLY SAFE WIRING

DO NOT SCALE
DRAWING NO. **2E-0042**
SCALE **1:1**
SHEET **4 of 4**

REVISIONS

REV	DESCRIPTION
00	

UNLESS OTHERWISE SPECIFIED, DIMENSIONS ARE IN INCHES (mm) PER ASME Y14.5-2009

TOLERANCES:

FRACTIONS	+ 0.001 (0)
DECIMALS	+ 0.001 (0)
ANGLES	+ 0.01 (0.25)
FINISH	125 / RMS

PERMISSION: NEITHER RECEIPT NOR FROM ANY SOURCE, CONSTITUTES SUCH OR DISCLOSE BY ANYONE WITHOUT MRS EXPRESS WRITTEN PERMISSION IS CRIMINAL AND CIVIL LIABILITY.

PROPERTY: THIS DOCUMENT IS THE PROPERTY OF MILTON ROY. IT IS TO BE KEPT AND RETURNED TO MILTON ROY WITHIN 30 DAYS OF THE DATE OF RECEIPT. IT IS TO BE KEPT AND RETURNED TO MILTON ROY WITHIN 30 DAYS OF THE DATE OF RECEIPT. IT IS TO BE KEPT AND RETURNED TO MILTON ROY WITHIN 30 DAYS OF THE DATE OF RECEIPT.

APPENDIX A: ILLUSTRATIONS

Figure 21

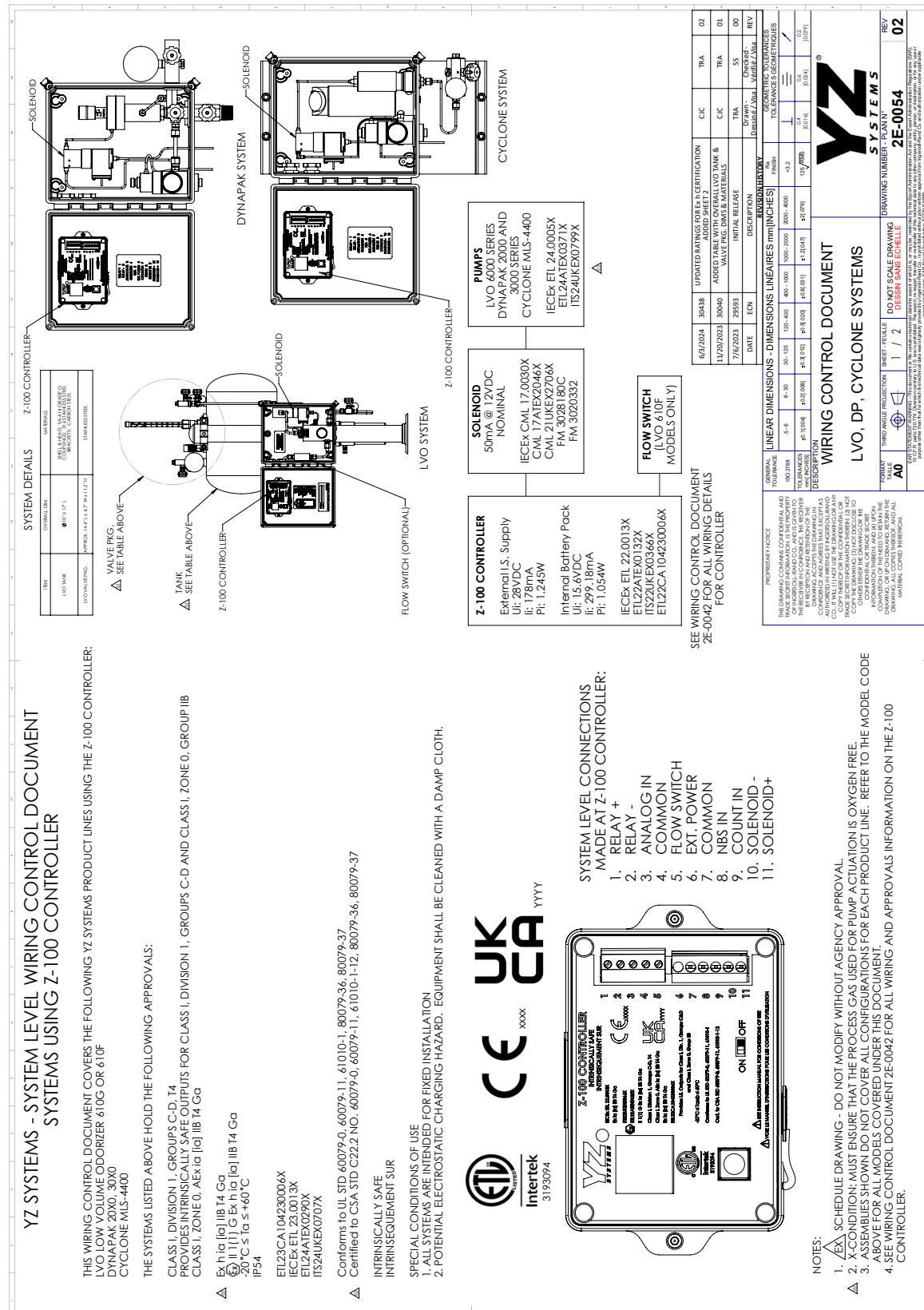

APPENDIX A: ILLUSTRATIONS

Figure 22

LVO LOW VOLUME ODORIZER 610G OR 610F SYSTEM NOTES:

- FLOODED SUCTION REQUIRED FOR PRINKING.
- SHALL NOT BE USED WITHOUT A PROCESS MEDIUM
- COMPATIBLE FLUIDS: GROUP IIC GASES AND NATURAL GAS ODORANTS (VARIOUS BLENDS)
- INLET ACTUATION PRESSURE: 30 - 60 PSI
- MAXIMUM PROCESS PRESSURE: 40 PSI
- OPERATING SYSTEM TEMPERATURE: -41°F to +140°F (-20°C to +60°C)

INSTALLATION INSTRUCTIONS:

- SYSTEM SHOULD BE MOUNTED IN A VERTICAL POSITION
- CONNECT A GROUND WIRE FROM THE Z PIP TO A PROPERLY INSTALLED GROUND ROD
- PRESSURE TEST SYSTEM PRIOR TO TURNING ON

MAINTENANCE:

- SEE TABLE BELOW
- SEE FULL SYSTEM LEVEL MANUAL FOR TROUBLESHOOTING STEPS

REPAIR:

- SYSTEM SHALL BE PURGED AND VENTED PRIOR TO SERVICING
- SYSTEM SHALL HAVE POWER DISCONNECTED PRIOR TO SERVICING
- PRESSURE TEST SYSTEM AFTER SERVICING

DYNAPAK 20X0, 30X0 SYSTEM NOTES:

- FLOODED SUCTION REQUIRED FOR PRINKING
- SHALL NOT BE USED WITHOUT A PROCESS MEDIUM
- COMPATIBLE FLUIDS: GROUP IIC GASES, ODORIZED OR UNODORIZED
- INLET ACTUATION PRESSURE: 50 - 65 PSIG
- MAXIMUM PROCESS PRESSURE: 500 PSIG
- OPERATING SYSTEM TEMPERATURE: -41°F to +140°F (-20°C to +60°C)

INSTALLATION INSTRUCTIONS:

- SAMPLES SHOULD BE MINIMUM OF FIVE PIPE DIAMETERS FROM ANY DEVICE
- SYSTEM SHOULD BE MOUNTED IN A VERTICAL POSITION
- SUCTION REQUIRES 1/2" OR 3/4" FNPT PIPELINE CONNECTION DEPENDING ON MODEL
- END OF SAMPLER PROBE SHOULD PENETRATE THE CENTER 1/3RD OF THE PIPELINE
- BEFORE APPLYING PIPELINE PRESSURE, ENSURE THE ISOLATION & PURGE VALVES ARE GOOD
- AFTER APPLYING PIPELINE PRESSURE, CHECK ALL CONNECTIONS USING LIQUID LEAK DETECTOR

MAINTENANCE:

- SEE TABLE BELOW
- SEE FULL SYSTEM LEVEL MANUAL FOR TROUBLESHOOTING STEPS

REPAIR:

- SYSTEM SHALL BE PURGED AND VENTED PRIOR TO SERVICING
- SYSTEM SHALL HAVE POWER DISCONNECTED PRIOR TO SERVICING
- PRESSURE TEST SYSTEM AFTER SERVICING

CYCLONE MLS-4400 SYSTEM NOTES:

- FLOODED SUCTION REQUIRED FOR PRINKING
- SHALL NOT BE USED WITHOUT A PROCESS MEDIUM
- COMPATIBLE FLUIDS: GROUP IIC GASES, CHEMILUBE, ANDEROL, SW OR EQUIVALENT
- INLET ACTUATION PRESSURE: 15 - 55 PSI
- MAXIMUM PROCESS PRESSURE: 500 PSIG
- OPERATING SYSTEM TEMPERATURE: -41°F to +140°F (-20°C to +60°C)

INSTALLATION INSTRUCTIONS:

- SYSTEM SHOULD BE MOUNTED IN A VERTICAL POSITION
- SUCTION 1/4" FNPT PIPELINE CONNECTION REQUIRED
- DISCHARGE 1/8" TUBING TO INJECTION PORT ALONG WITH A CHECK VALVE
- PRESSURE TEST SYSTEM PRIOR TO TURNING ON

MAINTENANCE:

- SEE TABLE BELOW
- SEE FULL SYSTEM LEVEL MANUAL FOR TROUBLESHOOTING STEPS

REPAIR:

- SYSTEM SHALL BE PURGED AND VENTED PRIOR TO SERVICING
- SYSTEM SHALL HAVE POWER DISCONNECTED PRIOR TO SERVICING
- PRESSURE TEST SYSTEM AFTER SERVICING

LVO 610G OR 610F MAINTENANCE SCHEDULE	
ITEM	INTERVAL
VERIFY GAS PRESSURES	EVERY WEEK
CHECK FOR GAS & ODORANT LEAKS	EVERY WEEK
VISUALLY INSPECT FOR OBVIOUS EXTERNAL PROBLEMS	EVERY WEEK
INSPECT OVERFLOW PROTECTOR & SERVICES AS NEEDED	EVERY 6 MONTHS
INSPECT TUBE FITTINGS AND VALVE PACKINGS FOR LEAKS	EVERY 6 MONTHS
CHANGE FILTERS	EVERY 12 MONTHS
REBUILD PUMP	EVERY 12 MONTHS
REPLACE SOLENOIDS	EVERY 12 MONTHS
TEST REGULATORS & SERVICE AS NEEDED	EVERY 12 MONTHS
CONDITION ODORANT AS NEEDED	EVERY 12 MONTHS
TEST SYSTEM PERFORMANCE	EVERY 12 MONTHS
REPLACE BATTERY	* EVERY 12 MONTHS

DYNAPAK 20X0, 30X0 MAINTENANCE SCHEDULE	
ITEM	INTERVAL
VERIFY SYSTEM PRESSURE	EVERY MONTH
CHECK FOR LEAKS	EVERY MONTH
TEST BATTERY	EVERY MONTH
CLEAN & LUBRICATE PUMP	EVERY 6 MONTHS
CHECK FILTER ELEMENT & REPLACE IF NEEDED	EVERY 6 MONTHS
REBUILD PUMP	EVERY 12 MONTHS
TEST SYSTEM PERFORMANCE & SERVICE AS NEEDED	EVERY 12 MONTHS
REPLACE BATTERY	EVERY 12 MONTHS

CYCLONE MLS-4400 MAINTENANCE SCHEDULE	
ITEM	INTERVAL
CLEAN & INSPECT INJECTOR PUMP	EVERY 6 MONTHS
CHECK FILTER ELEMENT	EVERY 6 MONTHS
TEST BATTERY	EVERY MONTH

ENCLOSURE DETAILS

ITEM	OVERALL DIM.	MATERIALS
ENCLOSURE WITH QUICK-RELEASE LATCHES (COMMON)	10.5" L x 8.5" W x 6.3" D	ENCLOSURE: RUBBER GLASS
LIQUID TIGHT FITTING PLUGS (COMMON) - QTY 2	7/16" OD	ENCLOSURE HARDWARE 316 STAINLESS STEEL
MANIFOLD GASKET (LVO)	1.35" W x 2.85" L x 0.06" T	RUBBER
PUMP GASKET (LVO)	2.53" OD x 1.49" ID x 0.06" T	NITRILE
TUBING GROMMET (LVO) - QTY 1 (1.0F)	1/4" ID x 1/2 GRV DIA x 1/8" GRV W	RUBBER
PIPE GROMMET (DYNAPAK)	3/4" ID x 1/16 GRV DIA x 1/8" GRV W	RUBBER
PUMP GASKET (DYNAPAK)	2" OD x 1.25" ID x 1.25" T	NEOPRENE
FILTER / REGULATOR GASKET (DYNAPAK & CYCLONE)	2" OD x 1.25" ID x 1.25" T	NEOPRENE
TUBING GROMMET (DYNAPAK & CYCLONE) - QTY 2	1/8" ID x 5/16" GRV DIA x 1/8" GRV W	RUBBER
PUMP GASKET (CYCLONE)	1.5" OD x .75" ID x 1.25" T	RUBBER
RESERVOIR GASKET (CYCLONE)	2" x 1.25" T	RUBBER

ENCLOSURE DETAILS

ITEM	OVERALL DIM.	MATERIALS
ENCLOSURE WITH QUICK-RELEASE LATCHES (COMMON)	10.5" L x 8.5" W x 6.3" D	ENCLOSURE: RUBBER GLASS
LIQUID TIGHT FITTING PLUGS (COMMON) - QTY 2	7/16" OD	ENCLOSURE HARDWARE 316 STAINLESS STEEL
MANIFOLD GASKET (LVO)	1.35" W x 2.85" L x 0.06" T	RUBBER
PUMP GASKET (LVO)	2.53" OD x 1.49" ID x 0.06" T	NITRILE
TUBING GROMMET (LVO) - QTY 1 (1.0F)	1/4" ID x 1/2 GRV DIA x 1/8" GRV W	RUBBER
PIPE GROMMET (DYNAPAK)	3/4" ID x 1/16 GRV DIA x 1/8" GRV W	RUBBER
PUMP GASKET (DYNAPAK)	2" OD x 1.25" ID x 1.25" T	NEOPRENE
FILTER / REGULATOR GASKET (DYNAPAK & CYCLONE)	2" OD x 1.25" ID x 1.25" T	NEOPRENE
TUBING GROMMET (DYNAPAK & CYCLONE) - QTY 2	1/8" ID x 5/16" GRV DIA x 1/8" GRV W	RUBBER
PUMP GASKET (CYCLONE)	1.5" OD x .75" ID x 1.25" T	RUBBER
RESERVOIR GASKET (CYCLONE)	2" x 1.25" T	RUBBER

ENCLOSURE DETAILS

ITEM	OVERALL DIM.	MATERIALS
ENCLOSURE WITH QUICK-RELEASE LATCHES (COMMON)	10.5" L x 8.5" W x 6.3" D	ENCLOSURE: RUBBER GLASS
LIQUID TIGHT FITTING PLUGS (COMMON) - QTY 2	7/16" OD	ENCLOSURE HARDWARE 316 STAINLESS STEEL
MANIFOLD GASKET (LVO)	1.35" W x 2.85" L x 0.06" T	RUBBER
PUMP GASKET (LVO)	2.53" OD x 1.49" ID x 0.06" T	NITRILE
TUBING GROMMET (LVO) - QTY 1 (1.0F)	1/4" ID x 1/2 GRV DIA x 1/8" GRV W	RUBBER
PIPE GROMMET (DYNAPAK)	3/4" ID x 1/16 GRV DIA x 1/8" GRV W	RUBBER
PUMP GASKET (DYNAPAK)	2" OD x 1.25" ID x 1.25" T	NEOPRENE
FILTER / REGULATOR GASKET (DYNAPAK & CYCLONE)	2" OD x 1.25" ID x 1.25" T	NEOPRENE
TUBING GROMMET (DYNAPAK & CYCLONE) - QTY 2	1/8" ID x 5/16" GRV DIA x 1/8" GRV W	RUBBER
PUMP GASKET (CYCLONE)	1.5" OD x .75" ID x 1.25" T	RUBBER
RESERVOIR GASKET (CYCLONE)	2" x 1.25" T	RUBBER

ENCLOSURE DETAILS

ITEM	OVERALL DIM.	MATERIALS
ENCLOSURE WITH QUICK-RELEASE LATCHES (COMMON)	10.5" L x 8.5" W x 6.3" D	ENCLOSURE: RUBBER GLASS
LIQUID TIGHT FITTING PLUGS (COMMON) - QTY 2	7/16" OD	ENCLOSURE HARDWARE 316 STAINLESS STEEL
MANIFOLD GASKET (LVO)	1.35" W x 2.85" L x 0.06" T	RUBBER
PUMP GASKET (LVO)	2.53" OD x 1.49" ID x 0.06" T	NITRILE
TUBING GROMMET (LVO) - QTY 1 (1.0F)	1/4" ID x 1/2 GRV DIA x 1/8" GRV W	RUBBER
PIPE GROMMET (DYNAPAK)	3/4" ID x 1/16 GRV DIA x 1/8" GRV W	RUBBER
PUMP GASKET (DYNAPAK)	2" OD x 1.25" ID x 1.25" T	NEOPRENE
FILTER / REGULATOR GASKET (DYNAPAK & CYCLONE)	2" OD x 1.25" ID x 1.25" T	NEOPRENE
TUBING GROMMET (DYNAPAK & CYCLONE) - QTY 2	1/8" ID x 5/16" GRV DIA x 1/8" GRV W	RUBBER
PUMP GASKET (CYCLONE)	1.5" OD x .75" ID x 1.25" T	RUBBER
RESERVOIR GASKET (CYCLONE)	2" x 1.25" T	RUBBER

ENCLOSURE DETAILS

ITEM	OVERALL DIM.	MATERIALS
ENCLOSURE WITH QUICK-RELEASE LATCHES (COMMON)	10.5" L x 8.5" W x 6.3" D	ENCLOSURE: RUBBER GLASS
LIQUID TIGHT FITTING PLUGS (COMMON) - QTY 2	7/16" OD	ENCLOSURE HARDWARE 316 STAINLESS STEEL
MANIFOLD GASKET (LVO)	1.35" W x 2.85" L x 0.06" T	RUBBER
PUMP GASKET (LVO)	2.53" OD x 1.49" ID x 0.06" T	NITRILE
TUBING GROMMET (LVO) - QTY 1 (1.0F)	1/4" ID x 1/2 GRV DIA x 1/8" GRV W	RUBBER
PIPE GROMMET (DYNAPAK)	3/4" ID x 1/16 GRV DIA x 1/8" GRV W	RUBBER
PUMP GASKET (DYNAPAK)	2" OD x 1.25" ID x 1.25" T	NEOPRENE
FILTER / REGULATOR GASKET (DYNAPAK & CYCLONE)	2" OD x 1.25" ID x 1.25" T	NEOPRENE
TUBING GROMMET (DYNAPAK & CYCLONE) - QTY 2	1/8" ID x 5/16" GRV DIA x 1/8" GRV W	RUBBER
PUMP GASKET (CYCLONE)	1.5" OD x .75" ID x 1.25" T	RUBBER
RESERVOIR GASKET (CYCLONE)	2" x 1.25" T	RUBBER

ENCLOSURE DETAILS

ITEM	OVERALL DIM.	MATERIALS
ENCLOSURE WITH QUICK-RELEASE LATCHES (COMMON)	10.5" L x 8.5" W x 6.3" D	ENCLOSURE: RUBBER GLASS
LIQUID TIGHT FITTING PLUGS (COMMON) - QTY 2	7/16" OD	ENCLOSURE HARDWARE 316 STAINLESS STEEL
MANIFOLD GASKET (LVO)	1.35" W x 2.85" L x 0.06" T	RUBBER
PUMP GASKET (LVO)	2.53" OD x 1.49" ID x 0.06" T	NITRILE
TUBING GROMMET (LVO) - QTY 1 (1.0F)	1/4" ID x 1/2 GRV DIA x 1/8" GRV W	RUBBER
PIPE GROMMET (DYNAPAK)	3/4" ID x 1/16 GRV DIA x 1/8" GRV W	RUBBER
PUMP GASKET (DYNAPAK)	2" OD x 1.25" ID x 1.25" T	NEOPRENE
FILTER / REGULATOR GASKET (DYNAPAK & CYCLONE)	2" OD x 1.25" ID x 1.25" T	NEOPRENE
TUBING GROMMET (DYNAPAK & CYCLONE) - QTY 2	1/8" ID x 5/16" GRV DIA x 1/8" GRV W	RUBBER
PUMP GASKET (CYCLONE)	1.5" OD x .75" ID x 1.25" T	RUBBER
RESERVOIR GASKET (CYCLONE)	2" x 1.25" T	RUBBER

ENCLOSURE DETAILS

ITEM	OVERALL DIM.	MATERIALS
ENCLOSURE WITH QUICK-RELEASE LATCHES (COMMON)	10.5" L x 8.5" W x 6.3" D	ENCLOSURE: RUBBER GLASS
LIQUID TIGHT FITTING PLUGS (COMMON) - QTY 2	7/16" OD	ENCLOSURE HARDWARE 316 STAINLESS STEEL
MANIFOLD GASKET (LVO)	1.35" W x 2.85" L x 0.06" T	RUBBER
PUMP GASKET (LVO)	2.53" OD x 1.49" ID x 0.06" T	NITRILE
TUBING GROMMET (LVO) - QTY 1 (1.0F)	1/4" ID x 1/2 GRV DIA x 1/8" GRV W	RUBBER
PIPE GROMMET (DYNAPAK)	3/4" ID x 1/16 GRV DIA x 1/8" GRV W	RUBBER
PUMP GASKET (DYNAPAK)	2" OD x 1.25" ID x 1.25" T	NEOPRENE
FILTER / REGULATOR GASKET (DYNAPAK & CYCLONE)	2" OD x 1.25" ID x 1.25" T	NEOPRENE
TUBING GROMMET (DYNAPAK & CYCLONE) - QTY 2	1/8" ID x 5/16" GRV DIA x 1/8" GRV W	RUBBER
PUMP GASKET (CYCLONE)	1.5" OD x .75" ID x 1.25" T	RUBBER
RESERVOIR GASKET (CYCLONE)	2" x 1.25" T	RUBBER

ENCLOSURE DETAILS

ITEM	OVERALL DIM.	MATERIALS
ENCLOSURE WITH QUICK-RELEASE LATCHES (COMMON)	10.5" L x 8.5" W x 6.3" D	ENCLOSURE: RUBBER GLASS
LIQUID TIGHT FITTING PLUGS (COMMON) - QTY 2	7/16" OD	ENCLOSURE HARDWARE 316 STAINLESS STEEL
MANIFOLD GASKET (LVO)	1.35" W x 2.85" L x 0.06" T	RUBBER
PUMP GASKET (LVO)	2.53" OD x 1.49" ID x 0.06" T	NITRILE
TUBING GROMMET (LVO) - QTY 1 (1.0F)	1/4" ID x 1/2 GRV DIA x 1/8" GRV W	RUBBER
PIPE GROMMET (DYNAPAK)	3/4" ID x 1/16 GRV DIA x 1/8" GRV W	RUBBER
PUMP GASKET (DYNAPAK)	2" OD x 1.25" ID x 1.25" T	NEOPRENE
FILTER / REGULATOR GASKET (DYNAPAK & CYCLONE)	2" OD x 1.25" ID x 1.25" T	NEOPRENE
TUBING GROMMET (DYNAPAK & CYCLONE) - QTY 2	1/8" ID x 5/16" GRV DIA x 1/8" GRV W	RUBBER
PUMP GASKET (CYCLONE)	1.5" OD x .75" ID x 1.25" T	RUBBER
RESERVOIR GASKET (CYCLONE)	2" x 1.25" T	RUBBER

ENCLOSURE DETAILS

ITEM	OVERALL DIM.	MATERIALS
ENCLOSURE WITH QUICK-RELEASE LATCHES (COMMON)	10.5" L x 8.5" W x 6.3" D	ENCLOSURE: RUBBER GLASS
LIQUID TIGHT FITTING PLUGS (COMMON) - QTY 2	7/16" OD	ENCLOSURE HARDWARE 316 STAINLESS STEEL
MANIFOLD GASKET (LVO)	1.35" W x 2.85" L x 0.06" T	RUBBER
PUMP GASKET (LVO)	2.53" OD x 1.49" ID x 0.06" T	NITRILE
TUBING GROMMET (LVO) - QTY 1 (1.0F)	1/4" ID x 1/2 GRV DIA x 1/8" GRV W	RUBBER
PIPE GROMMET (DYNAPAK)	3/4" ID x 1/16 GRV DIA x 1/8" GRV W	RUBBER
PUMP GASKET (DYNAPAK)	2" OD x 1.25" ID x 1.25" T	NEOPRENE
FILTER / REGULATOR GASKET (DYNAPAK & CYCLONE)	2" OD x 1.25" ID x 1.25" T	NEOPRENE
TUBING GROMMET (DYNAPAK & CYCLONE) - QTY 2	1/8" ID x 5/16" GRV DIA x 1/8" GRV W	RUBBER
PUMP GASKET (CYCLONE)	1.5" OD x .75" ID x 1.25" T	RUBBER
RESERVOIR GASKET (CYCLONE)	2" x 1.25" T	RUBBER

ENCLOSURE DETAILS

ITEM	OVERALL DIM.	MATERIALS
ENCLOSURE WITH QUICK-RELEASE LATCHES (COMMON)	10.5" L x 8.5" W x 6.3" D	ENCLOSURE: RUBBER GLASS
LIQUID TIGHT FITTING PLUGS (COMMON) - QTY 2	7/16" OD	ENCLOSURE HARDWARE 316 STAINLESS STEEL
MANIFOLD GASKET (LVO)	1.35" W x 2.85" L x 0.06" T	RUBBER
PUMP GASKET (LVO)	2.53" OD x 1.49" ID x 0.06" T	NITRILE
TUBING GROMMET (LVO) - QTY 1 (1.0F)	1/4" ID x 1/2 GRV DIA x 1/8" GRV W	RUBBER
PIPE GROMMET (DYNAPAK)	3/4" ID x 1/16 GRV DIA x 1/8" GRV W	RUBBER
PUMP GASKET (DYNAPAK)	2" OD x 1.25" ID x 1.25" T	NEOPRENE
FILTER / REGULATOR GASKET (DYNAPAK & CYCLONE)	2" OD x 1.25" ID x 1.25" T	NEOPRENE
TUBING GROMMET (DYNAPAK & CYCLONE) - QTY 2	1/8" ID x 5/16" GRV DIA x 1/8" GRV W	RUBBER
PUMP GASKET (CYCLONE)	1.5" OD x .75" ID x 1.25" T	RUBBER
RESERVOIR GASKET (CYCLONE)	2" x 1.25" T	RUBBER

ENCLOSURE DETAILS

ITEM	OVERALL DIM.	MATERIALS
ENCLOSURE WITH QUICK-RELEASE LATCHES (COMMON)	10.5" L x 8.5" W x 6.3" D	ENCLOSURE: RUBBER GLASS
LIQUID TIGHT FITTING PLUGS (COMMON) - QTY 2	7/16" OD	ENCLOSURE HARDWARE 316 STAINLESS STEEL
MANIFOLD GASKET (LVO)	1.35" W x 2.85" L x 0.06" T	RUBBER
PUMP GASKET (LVO)	2.53" OD x 1.49" ID x 0.06" T	NITRILE
TUBING GROMMET (LVO) - QTY 1 (1.0F)	1/4" ID x 1/2 GRV DIA x 1/8" GRV W	RUBBER
PIPE GROMMET (DYNAPAK)	3/4" ID x 1/16 GRV DIA x 1/8" GRV W	RUBBER
PUMP GASKET (DYNAPAK)	2" OD x 1.25" ID x 1.25" T	NEOPRENE
FILTER / REGULATOR GASKET (DYNAPAK & CYCLONE)	2" OD x 1.25" ID x 1.25" T	NEOPRENE
TUBING GROMMET (DYNAPAK & CYCLONE) - QTY 2	1/8" ID x 5/16" GRV DIA x 1/8" GRV W	RUBBER
PUMP GASKET (CYCLONE)	1.5" OD x .75" ID x 1.25" T	RUBBER
RESERVOIR GASKET (CYCLONE)	2" x 1.25" T	RUBBER

ENCLOSURE DETAILS

ITEM	OVERALL DIM.	MATERIALS
ENCLOSURE WITH QUICK-RELEASE LATCHES (COMMON)	10.5" L x 8.5" W x 6.3" D	ENCLOSURE: RUBBER GLASS
LIQUID TIGHT FITTING PLUGS (COMMON) - QTY 2	7/16" OD	ENCLOSURE HARDWARE 316 STAINLESS STEEL
MANIFOLD GASKET (LVO)	1.35" W x 2.85" L x 0.06" T	RUBBER
PUMP GASKET (LVO)	2.53" OD x 1.49" ID x 0.06" T	NITRILE
TUBING GROMMET (LVO) - QTY 1 (1.0F)	1/4" ID x 1/2 GRV DIA x 1/8" GRV W	RUBBER
PIPE GROMMET (DYNAPAK)	3/4" ID x 1/16 GRV DIA x 1/8" GRV W	RUBBER
PUMP GASKET (DYNAPAK)	2" OD x 1.25" ID x 1.25" T	NEOPRENE
FILTER / REGULATOR GASKET (DYNAPAK & CYCLONE)	2" OD x 1.25" ID x 1.25" T	NEOPRENE
TUBING GROMMET (DYNAPAK & CYCLONE) - QTY 2	1/8" ID x 5/16" GRV DIA x 1/8" GRV W	RUBBER
PUMP GASKET (CYCLONE)	1.5" OD x .75" ID x 1.25" T	RUBBER
RESERVOIR GASKET (CYCLONE)	2" x 1.25" T	RUBBER

ENCLOSURE DETAILS

ITEM	OVERALL DIM.	MATERIALS
ENCLOSURE WITH QUICK-RELEASE LATCHES (COMMON)	10.5" L x 8.5" W x 6.3" D	ENCLOSURE: RUBBER GLASS
LIQUID TIGHT FITTING PLUGS (COMMON) - QTY 2	7/16" OD	ENCLOSURE HARDWARE 316 STAINLESS STEEL
MANIFOLD GASKET (LVO)	1.35" W x 2.85" L x 0.06" T	RUBBER
PUMP GASKET (LVO)	2.53" OD x 1.49" ID x 0.06" T	NITRILE
TUBING GROMMET (LVO) - QTY 1 (1.0F)	1/4" ID x 1/2 GRV DIA x 1/8" GRV W	RUBBER
PIPE GROMMET (DYNAPAK)	3/4" ID x 1/16 GRV DIA x 1/8" GRV W	RUBBER
PUMP GASKET (DYNAPAK)	2" OD x 1.25" ID x 1.25" T	NEOPRENE
FILTER / REGULATOR GASKET (DYNAPAK & CYCLONE)	2" OD x 1.25" ID x 1.25" T	NEOPRENE
TUBING GROMMET (DYNAPAK & CYCLONE) - QTY 2	1/8" ID x 5/16" GRV DIA x 1/8" GRV W	RUBBER
PUMP GASKET (CYCLONE)	1.5" OD x .75" ID x 1.25" T	RUBBER
RESERVOIR GASKET (CYCLONE)	2" x 1.25" T	RUBBER

</



An Ingersoll Rand Business

201 Ivyland Road

Ivyland, PA 18974

P: 281.362.6500

F: 281.362.6513

techsupport@yzsystems.com

www.yzsystems.com