

CYCLONE 4400

Meter Lubrication System
With Z-100 Controller

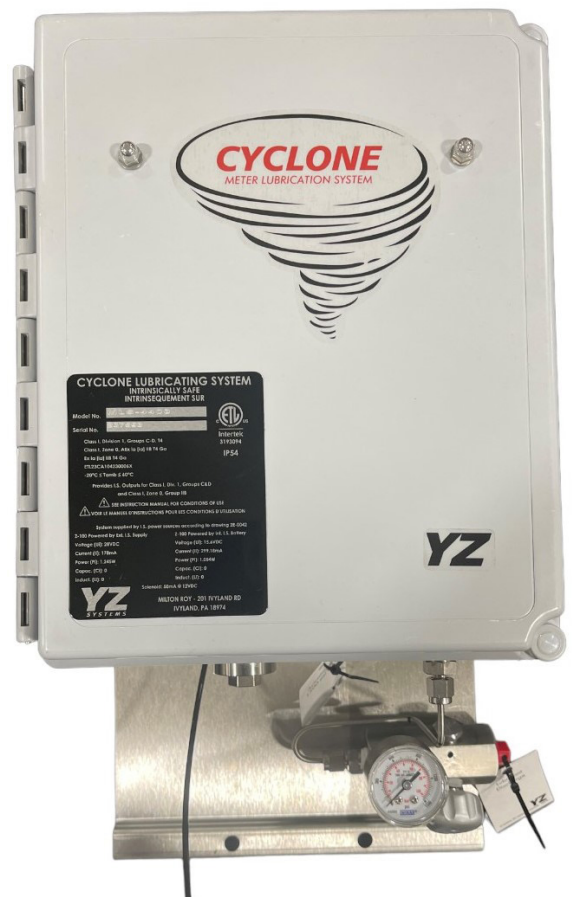

Learn More

YZ[®]
SYSTEMS

An Ingersoll Rand Business

CYCLONE 4400

INSTRUCTION & OPERATING

MANUAL

Version: 07-2024



4400 MLS TABLE OF CONTENTS

Table of Contents	I
Section 1: First Things To Know About MLS	1
Operation Specifications.....	1
Theory of Operation.....	1
System Accessories	2
Application	3
Section 2: System Installation	5
System Components	5
Injector Location	6
Injector Installation.....	7
Section 3: System Control and Electronics	9
Overview.....	10
Controller Overview	11
Z-100 Controller Operating modes	12
Home Screen.....	12
Signaled.....	12
Totalizer.....	12
Using the Z-100 Controller	13
Menu Screens	13
System ON/OFF	14
Change Z-100 Settings.....	14
Remote Inhibit	15
Alarm Output	15
Alarm Relay	15
Alarm Sources	15
Battery Low.....	16
Solenoid.....	16
Clock Menu.....	16
Date & Time Set	17
Resume on Power Loss	17
Units	17
Logs.....	18
DOU.....	18
Config	18
Event Logs.....	18
MM100.....	19
Test Menu.....	19
Test/Prime	19
RMT Inhibit	20
Pulse Test.....	20
Battery Test	21
Alarm Output Screen	22
Screen Test	22
Z-100 Product Info.....	22
Selecting the Z100 Operational Mode	23
Timer Mode	23
Counter Mode.....	24
Z-100 Set-up Proportional-to-Flow	25
Z-100 Set-up Proportional-to-Time.....	26
Operation Check and Leak Testing	27

4400 MLS TABLE OF CONTENTS

Table of Contents	I
Section 4: Injector Maintenance.....	29
Recommended preventative maintenance schedule.....	29
Recommended spare parts for the Cyclone 4400 MLS.....	29
Pump Rebuild - Disassembly	30
Pump Rebuild - Assembly	31
Battery Test	32
Replacing a depleted battery.....	33
Solenoid Maintenance	34
Section 5: TroubleShooting.....	36
How to use this section.....	36
For Additional Help	36
Step-by-Step Resolution.....	36
Battery Power	37
Battery Power Troubleshooting steps.....	37
Trouble Shooting: Timer Mode	37
Trouble Shooting: Counter Mode	38
Mechanical Assembly	39
Appendix A: Illustrations	41
C-44 Pump Assembled.....	41
C-44 Pump Exploded	42
YZ Filter/Regulator Assembled.....	43
Z-100 Controller.....	44
Z-100 Installation Drawing.....	45
Wiring Control Documentation.....	49
Pump Control Document	51

SECTION 1: FIRST THINGS TO KNOW ABOUT MLS

Operation Specifications

Injection Pump

Operating Pressure:	15 - 1500 psi.(1.03-103.4 Bar (g))
Actuation Pressure:	15 - 55 psi.(1.03-3.79 Bar (g))
Displacement:	.140 cc (fixed)
Operating System Temperature:	*-4°F to 140°F(-20°C to 60°C)

Service Connections

Actuation Gas Inlet:	1/4" NPT Female
Lubricant Discharge:	1/8" S/ST tube, Ferrule

Oil Reservoir

Material:	Polycarbonate & Anodized Aluminum
Capacity:	6 oz. (175 cc) (1250 injections)
Compatible Lubricants:	Chemlube, Anderol, 5w or equivalent

Controller

Power Supply:	Lithium battery pack
Battery Reserve:	2 years (1 stroke/hr)
Timer Accuracy:	< + 0.01%, deviation from absolute
Display:	LCD, indicating total injections (re-settable)
Flow input:	
Continuous:	20 Hz
Minimum Pulse Width:	20 ms
Pulse Type:	Electronic, 5 — 24VDC Dry, Contact Closure

Operating Mode

Timer Mode, Continuous:	0.10 to 100.0 hours (incrementally adjustable)
	0.10 to 100.0 hours in 0.01 hour increments

Remote Inhibit

Allows remote pausing of the system. See RMT INHIBIT. Refer [Page 20](#)

Proportional-to-Flow Mode

10 to 9900 pulses per injection (incrementally adjustable)

***NOTE:** Operation at extreme temperatures may affect system performance. To enhance the performance of this system, adequate heat should be provided to maintain an operating environment above 30° F (-1° C).

SECTION 1: FIRST THINGS TO KNOW ABOUT MLS

Theory of Operation

The Cyclone 4400 MLS is a pipeline mounted system which uses the pneumatically operated, positive displacement Cyclone 4400 pump, the Z-100 controller, the YZ filter/regulator and a low power solenoid valve to deliver injections.

The 4400 provides two modes of operation:

Time-based injection

- In this mode of operation, the 4400 injects lubricant into the meter at regular time intervals. The volume of injection is preset at .140 cc/stroke. The Z-100 controller operates as a recycling timer, periodically energizing a low power solenoid valve. Energizing the solenoid valve allows actuation gas to stroke the C-44 pump. The rate at which this occurs is a function of operator input. Modes are used to set the off time interval. The number of times the solenoid output is activated is recorded by the onboard LCD stroke indicator.

Proportional-to-flow injection

- In this mode of operation, the Z-100 counter operates as a dividing counter. The Z-100 counter periodically energizes a low power solenoid valve. As in the other two modes of operation, this allows actuation gas to stroke the C-44 pump. The rate at which this occurs is a function of operator input as well as the host computer or other device that inputs pulses per volume metered. The cycle time screen from the mode menu on the Z-100 are used to set the number of pulses the counter will count before activating the solenoid output. The number of times the solenoid output is activated is recorded by the onboard display.

- In two modes of operation, the Z-100 timer/counter operates using a replaceable internal battery pack. The battery pack condition is monitored by way of two indicator LEDs. When the battery pack needs replacement, the red LED will illuminate when the solenoid output is activated. If the battery pack is good, the green LED will illuminate when the solenoid is activated.

System Accessories

- **The External Power Option** can be used in lieu of the internal battery pack. The External Power Option consists of an AC to DC convertor and intrinsically safe barrier to convert 120 VAC power to 24 VDC to operate the controller without the use of the internal battery pack.
- **The Solar Power Option** can be used in lieu of the internal battery pack. The Solar Power Option consists of a 5 watt solar panel with a charger regulator module and internal 12VDC, 5 Amp hour battery pack.
- 1/8" stainless steel Check Valve. These should be installed in every tubing line that attaches a MLS 4400 to a meter. (P/N A3-0228).

A complete line of accessories is available through YZ. Please contact your local representative:

Technical Support (T): 1-281-362-6500
1-800-NJEX-HELP
(1-800-653-9435)

Email: techsupport@yzsystems.com

SECTION 1: FIRST THINGS TO KNOW ABOUT MLS

Application

One of the difficulties in maintaining turbine meters in the field is that they require lubricant for the unrestricted movement of the turbine, and for measurement accuracy.

Maintaining the lubricant level in meters is a problem that has existed for a very long time. Today, at YZ Systems, we have the solution in the Cyclone Meter Lubrication System 4400.

Features & Benefits

- Provides Systematic Lubrication to the meter for ensured measurement accuracy and durability
- Versatile electronic controller for time-based and proportional-to-flow operation
- Durable IP54 fiberglass reinforced polyester enclosure to protect from the elements
- Flexible dry contact or voltage pulse flow input
- A menu driven display & LED stroke indicator
- Adjustable Filter/Regulator provides actuation gas
- On-board 6 oz. oil reservoir
- Long life potted electronics
- Intrinsically Safe with Global certifications
- Convenient termination block for customer connections.

SECTION 2: SYSTEM INSTALLATION

System Components

The primary components of the Cyclone 4400 MLS (Meter Lubrication System) are illustrated below:

Figure 1

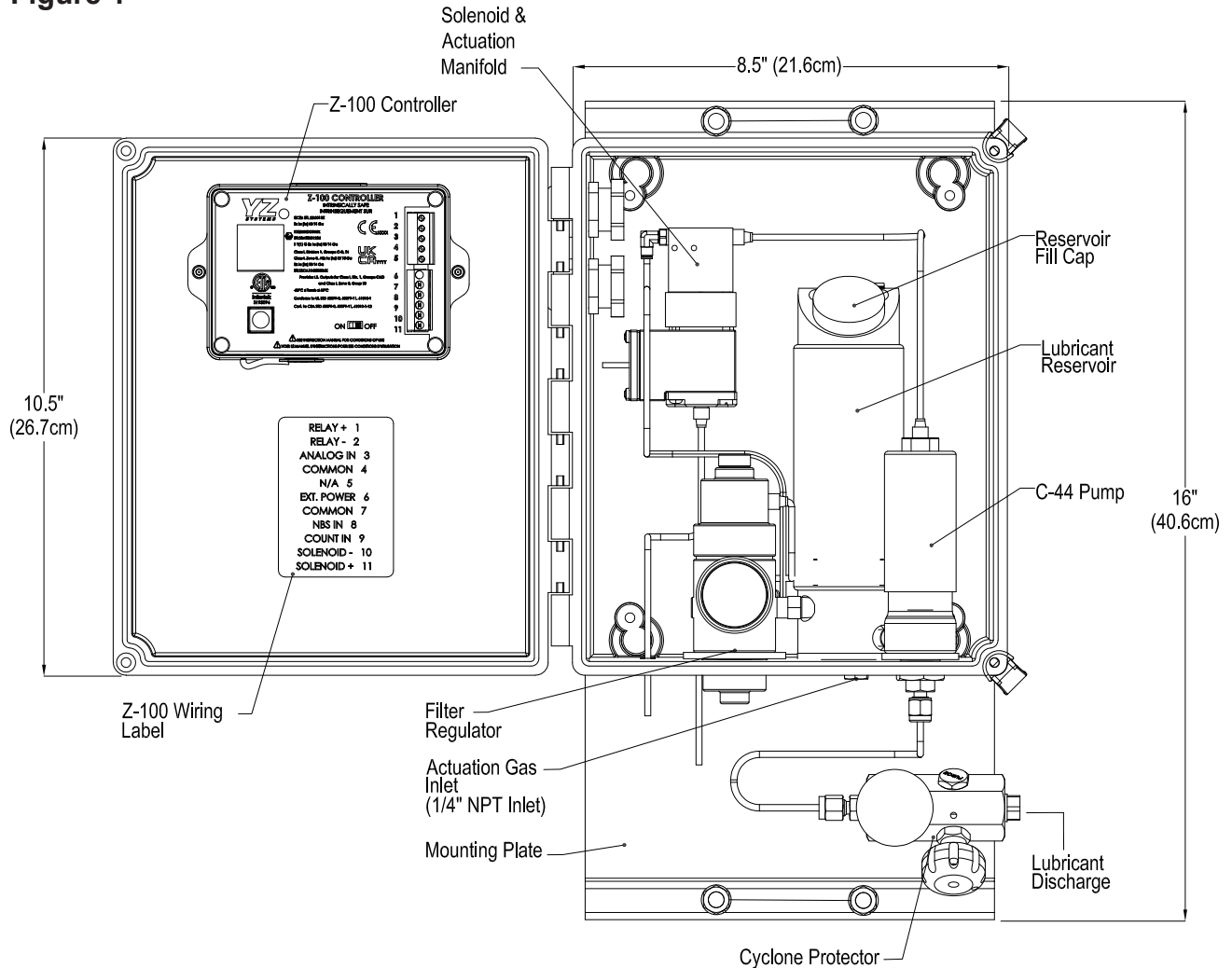

CLASS I, DIVISION 1, GROUPS C-D, T4
 PROVIDES INTRINSICALLY SAFE OUTPUTS FOR CLASS I, DIVISION 1, GROUPS C-D AND CLASS I, ZONE 0, GROUP IIB
 CLASS I, ZONE 0, AEx ia [ia] IIB T4 Ga

Ex h ia [ia] IIB T4 Ga
 Ⓜ II 1(1) G Ex h ia [ia] IIB T4 Ga
 -20°C ≤ Ta ≤ +60°C
 IP54

ETL23CA104230006X
 IECEx ETL 23.0013X
 ETL24ATEX0290X
 ITS24UKEX0707X

Conforms to UL STD 60079-0, 60079-11, 61010-1, 80079-36, 80079-37
 Certified to CSA STD C22.2 NO. 60079-0, 60079-11, 61010-1-12, 80079-36, 80079-37

SECTION 2: SYSTEM INSTALLATION

Injector Location

- The injector unit should be located as close to meter as possible. In addition, discharge tubing should be kept as short as possible.
- The injector unit is designed to mount to a 2" pole. The recommend mounting configuration is shown below.

Figure 2

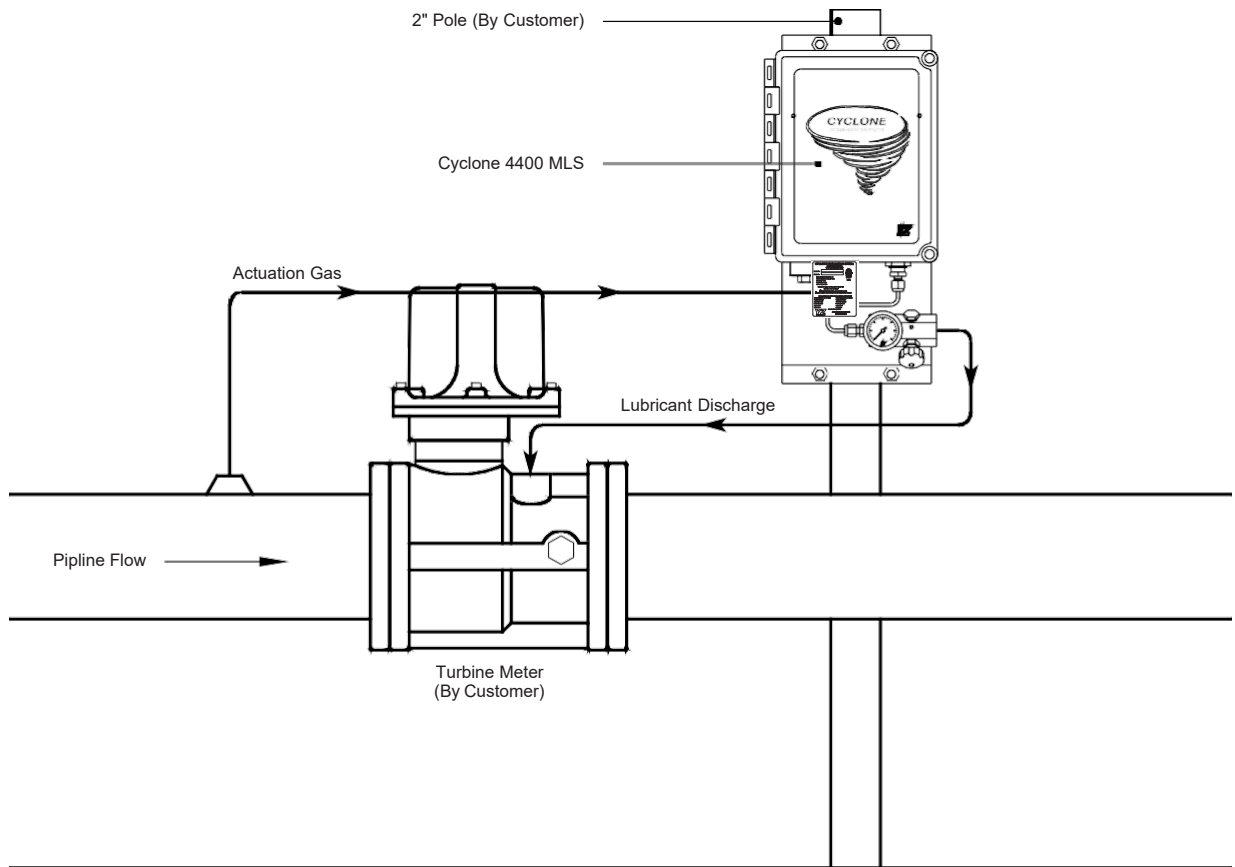

SECTION 2: SYSTEM INSTALLATION

Injector Installation

- The Cyclone 4400 should be mounted in a vertical position.
- The Cyclone 4400 requires a 1/4" NPT pipeline gas connection.
- The 1/8" discharge tubing should connect to the meter injection port. An in-line check valve should be installed at the injection port.

Figure 3

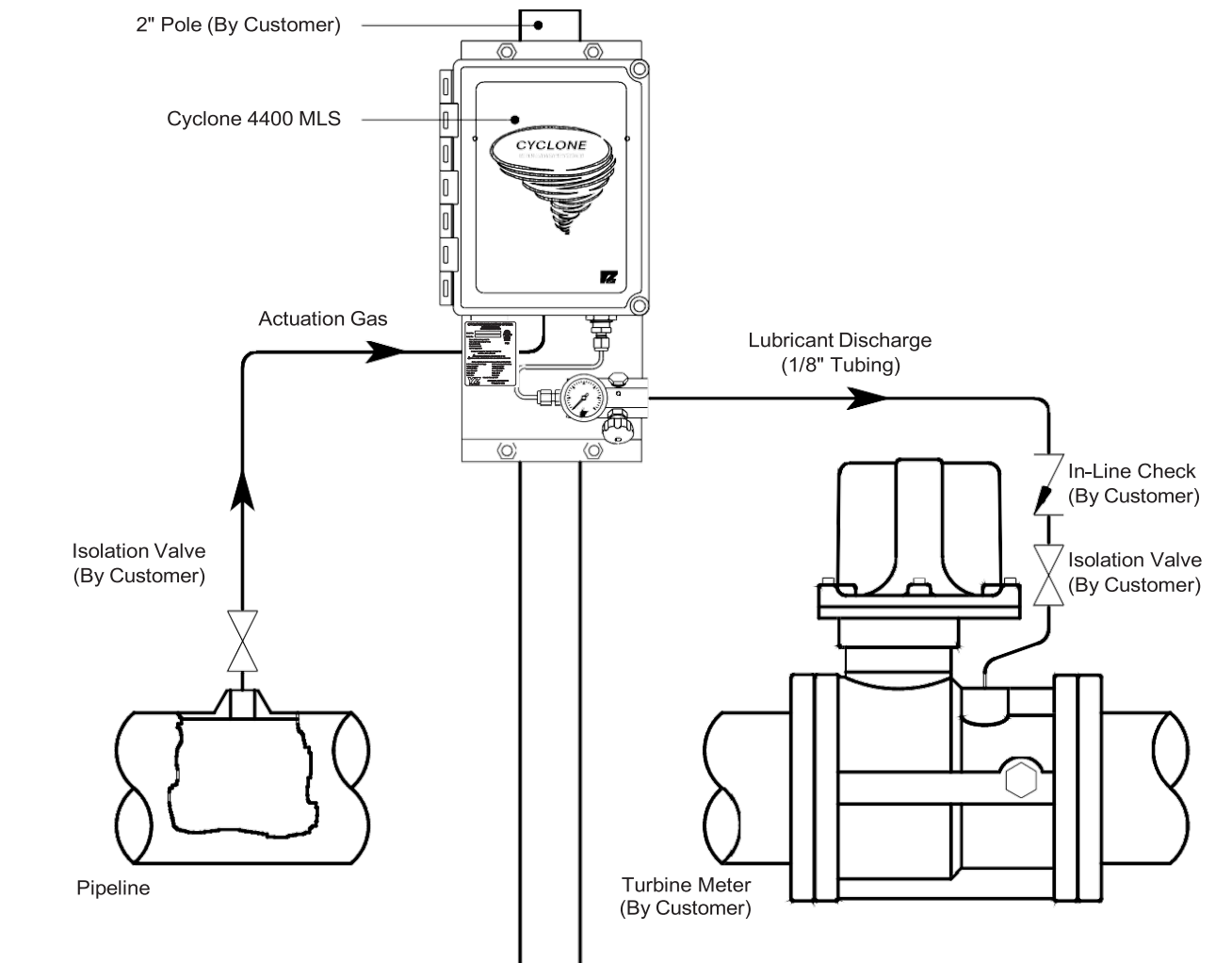

SECTION 3: SYSTEM CONTROL AND ELECTRONICS

Figure 4

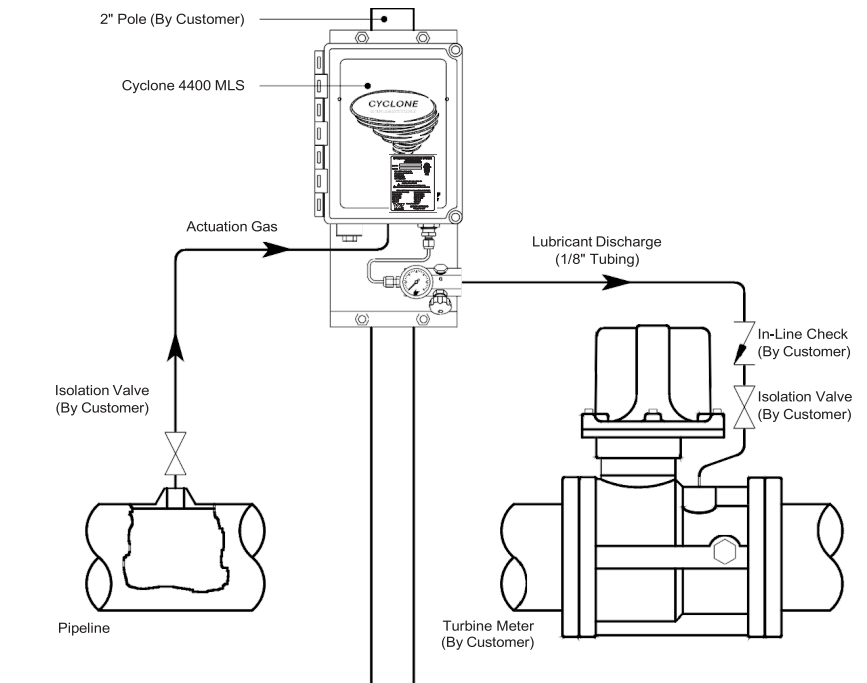
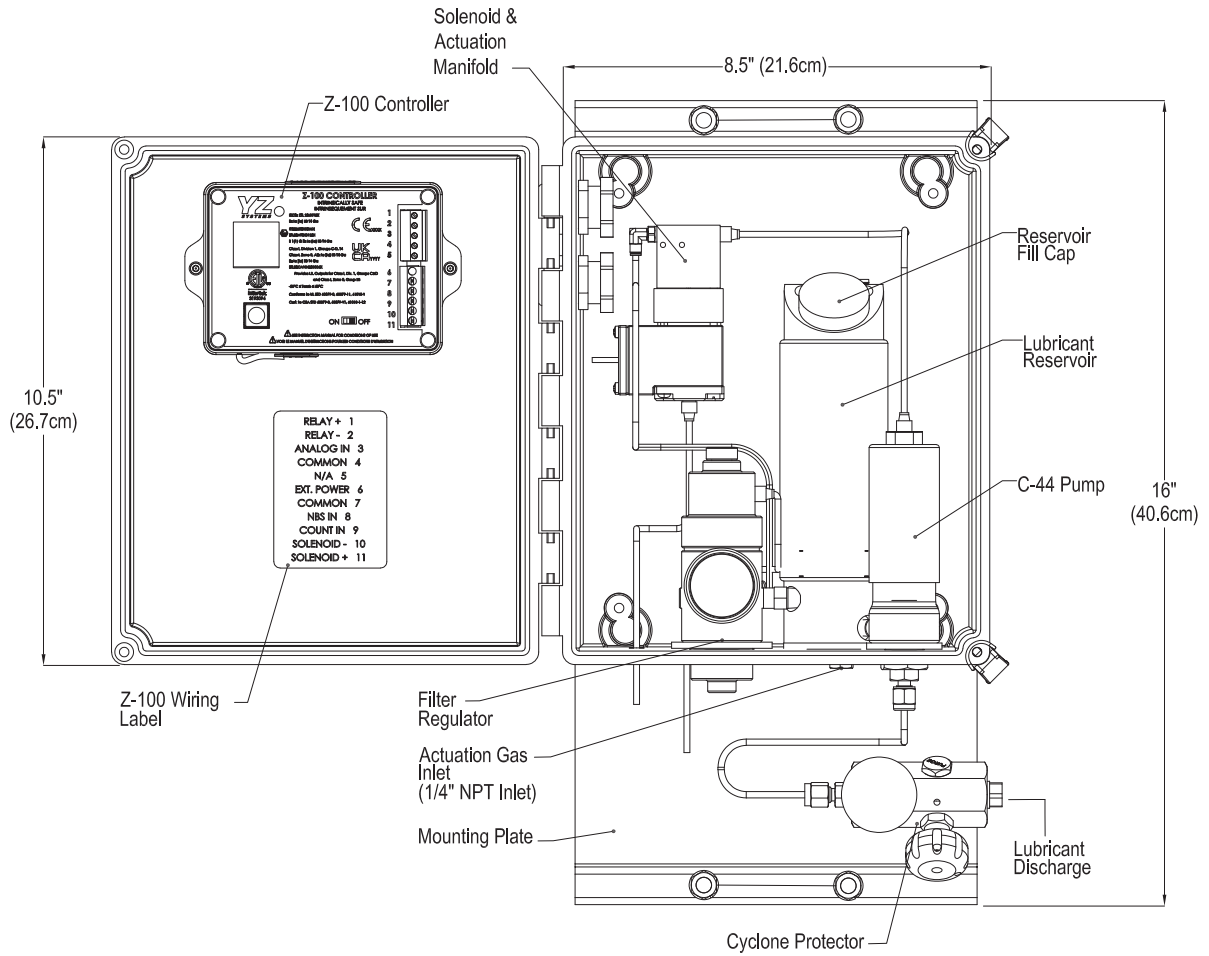

SECTION 3: SYSTEM CONTROL AND ELECTRONICS

Overview

The electronic control package provided with your Cyclone system consists of Z-100 controller powered by an internal battery or external power supply and a low power solenoid. The Z-100 Controller will control the timing of the C-44 Pump based on the controller settings and mode of operation, either proportion to flow or time. When lubricant is required, the controller will energize the solenoid, allowing the actuation gas to activate the C-44 Pump.

SAFETY NOTES: Always take the necessary measures to verify whether the area has an explosive atmosphere and obtain necessary work permits are obtained and safety protocols followed. as required by the areas of installation. Use the wiring label in the door of the Cyclone system, also shown to the right, to make your connections to the Z-100 controller. Please note some connections may share a common Ground connection. All wiring connected to the Z-100 controller must be done in accordance with the [Wiring Control Document](#), see [Appendix A](#). The Z-100 is rated for use in Class I, Division 1, Groups C&D and IECEx/ATEX Zone 0 hazardous locations.

WARNING

- Electrostatic Discharge Hazard – Wipe with a damp cloth only.
- System is top-heavy. Lift cabinet with rigging to support weight and prevent it from tipping.
- The Z-100 controller is in a housing with more than 10% aluminum. Non-sparking tools must be used while servicing the Z-100 controller to avoid an ignition hazard due to impact or friction.
- Customer to ensure inlet actuation supply pressure does not exceed 90 psi (6.2 bar).

Figure 5

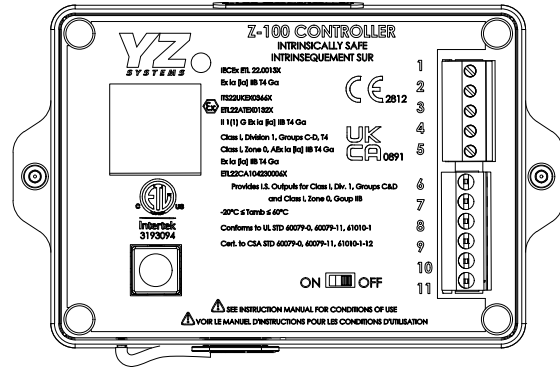

Z-100 CONTROLLER APPROVALS

IECEx ETL 22.0013X
 Ex ia [ia] IIB T4 Ga

ITS22UKEX0366X
 ETL22ATEX0132X

II 1(1) G Ex ia [ia] IIB T4 Ga
 Class I, Division 1, Groups C-D, T4
 Class I, Zone 0, AEx ia [ia] IIB T4 Ga
 Ex ia [ia] IIB T4 Ga

ETL22CA104230006X

Provides I.S. Outputs for Class I, Div. 1, Groups C&D
 and Class I, Zone 0, Goup IIB

-20°C ≤ Tamb ≤ 60°C

Conforms to UL STD 60079-0, 60079-11, 61010-1
 Cert. to CSA STD 60079-0, 60079-11, 61010-1-12

RELAY + 1
 RELAY - 2
 ANALOG IN 3
 COMMON 4
 N/A 5
 EXT. POWER 6
 COMMON 7
 NBS IN 8
 COUNT IN 9
 SOLENOID - 10
 SOLENOID + 11

SECTION 3: SYSTEM CONTROL AND ELECTRONICS

Programming Z-100 Controller

Controller Overview

To begin initial setup of the Z-100 Controller, move the Power switch, located on the front panel, to the ON position. The YZ logo will be shown while the controller is initializing then the Home Screen will be displayed when ready to operate.

The navigation switch has 5 functions: UP, DOWN, RIGHT, LEFT, and ENTER (center press). Pressing the switch in the appropriate direction to move between menus, and a center key to select sub menus or to modify, select, and save settings.

When moving between screens arrows will be shown on the display indicating what keys are active and their functions. Example illustration: the small down arrow indicates pressing the down key will allow you to scroll to additional Home Screen information. The right arrow next to "Menu" indicates pressing the right arrow will take you to the "Menu" Screen. See detailed navigation switch functionality in [Section 05](#), menu screens.

When the controller starts, the YZ Systems logo will load and the Home Screen will be displayed. The navigation switch will be used to navigate menus, change parameters, enter changes, etc. To navigate the controller, you will press the navigation switch in the direction you would like to move.

To open sub-menus, enter parameters, etc. you will use the navigation like a push button and push by pressing in the center of the switch. When viewing a screen, note if there is an arrow at the top or bottom of the screen. If a small arrow is shown, it indicates you can scroll down or navigate in that direction. On some screens, additional instructions may be shown in the bottom corners.

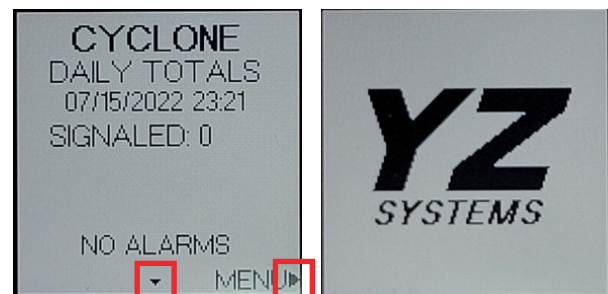
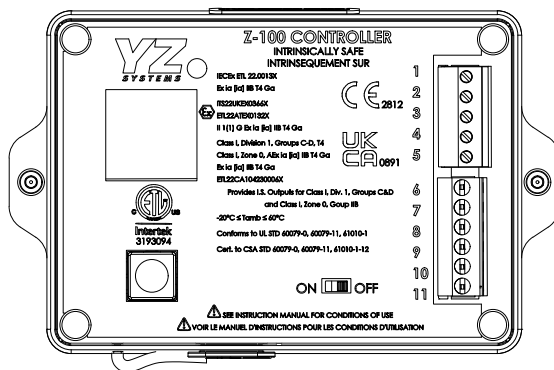

Figure 6



SECTION 3: SYSTEM CONTROL AND ELECTRONICS

Z-100 controller operating modes

Home Screen

Total signaled count is displayed on the main Home Screen. This screen resets at midnight each day. Where the display shows DAILY TOTALS, this line will alternate between showing DAILY TOTALS and the running mode. It will display TIMER or COUNTER or ANALOG followed by OFF or ON.

Signaled

Signaled is the count of how many times the controller sent a signal to the solenoid to stroke the pump.

Totalizer

From the Home Screen, you can navigate to the Totalizer by pressing down on the navigation button. The totalizer is a running total of how much sampling has been pumped. The date the totalizer was started will be displayed at the top, along with the current date and time. The display will show NA for number of strokes. The totalizer can be reset by pressing the navigation button in and holding until the value and date resets.

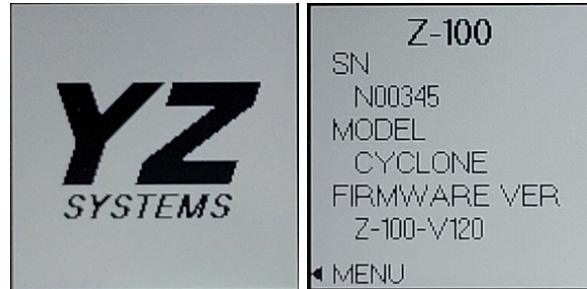

SECTION 3: SYSTEM CONTROL AND ELECTRONICS

Using The Z-100 Controller

The Z-100 user interface has been designed for easy navigation and setting of parameters.

The following sections outline the various screens and the steps needed to change and save settings.

Menu Screens

To navigate to a Menu or Sub Menu screen, use the navigation switch and push up or down to highlight the desired option. The selected option will be highlighted with an asterisk to the left. To open that menu item and press the navigation switch. Note the instructions on the bottom row of the screen for additional information or how to navigate back to the previous screen.

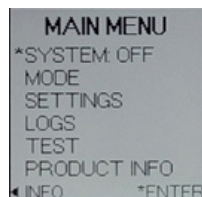

Modifying Controller Settings: Z-100 Controller settings will either be a value that must be changed, an item selected from a list, or a multiple-choice parameter option.

For items requiring a number to be edited, like the odorant density below, each digit will need to be changed individually. Note the arrow underneath the digit that is currently being edited. Press the left or right arrow to change which digit is updated. To change the value, press the navigation switch up or down. Move to the next digit as needed. To cancel the change, navigate to the back button and Press enter on the navigation switch to go back to the previous screen. To save the change, navigate to the Save option and Press enter on the navigation switch to save.

For an item that must be selected from a menu such as the pump spacer, the option that is currently selected will be shown with a dash next to it on the left. To change the selection, use the navigation switch and move up and down to the desired option. The possible selection will be shown with an asterisk to the left. Press the navigation switch to confirm the selected option.

Lastly, for the alarm sources, you can select multiple options to turn on or off each alarm source. The alarms will be shown with a dash next to it to indicate the alarm is active. The activate or deactivate an alarm, press the navigation switch up or down to the desired alarm source, the elected alarm will have an asterisk to the left. Press the navigation switch to enable or disable the alarm, if disabled the dash will be removed.

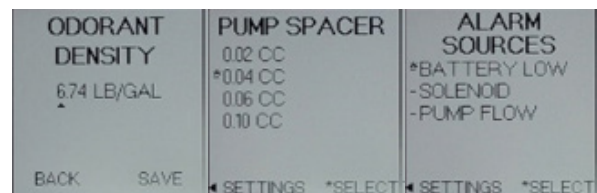

SECTION 3: SYSTEM CONTROL AND ELECTRONICS

System ON/OFF

This menu, is used to start and stop the system.

Select ON to start pumping as per the settings on the controller. Actuate the pump once immediately after turning the system ON and then begin pumping as per the current operating mode and settings. Settings cannot be modified while the system is ON, If a settings change is attempted while the system is ON, the controller will display a popup notification prompting to STOP the system. Selecting Yes will turn the OFF and display the setting to be modified. Selecting No will leave the system ON and return to the previous menu.

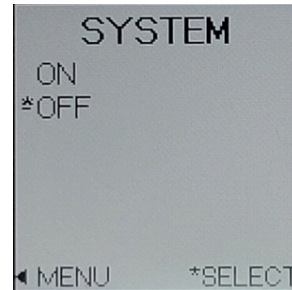

The system must be re-started once settings changes are completed.

Change Z-100 Settings

Go back to Main menu and scroll down to Settings tab and press Enter.

In order to run the pump system to the proper sampling rate, the settings must be set within the settings menu. From the Home Screen, open the Main Menu and navigate to the Settings parameter and press the navigation button in to open. To modify each setting, navigate to the setting and press the navigation button in to open. The active setting will be indicated with an asterisk (*) on the left side. Press the left arrow to return to the Main Menu. The small arrow at the bottom or top of the screen indicates there are additional parameters to scroll through.

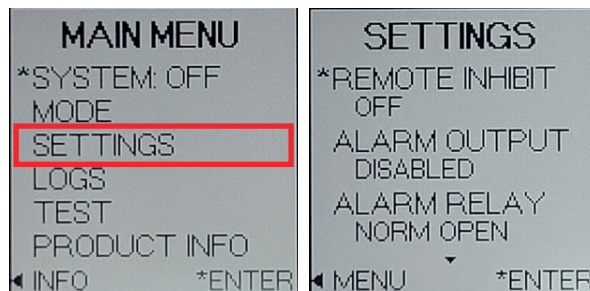

SECTION 3: SYSTEM CONTROL AND ELECTRONICS

Remote Inhibit

Remote inhibit allows the end user to stop the unit remotely if wired. To use this feature, it must be set to ON in the Remote Inhibit menu. Remote inhibit allows an operator to have a remote signal to stop pumping.

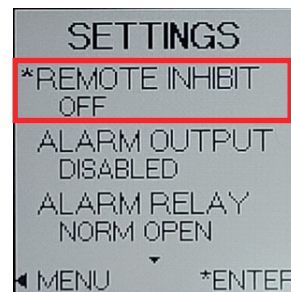

Alarm Output

The Alarm Output screen allows you to test the alarm output is being sent properly to the customer monitoring system. To test, ensure that the alarm output option has been enabled from the settings menu and the relay type selected as normally open or normally closed. Open the Test Alarm Output option by pressing the navigation button in to enter. The Test Alarm Output screen will display whether the alarm output is normally open or normally closed. Press the navigation button in to toggle the alarm. While the alarm is toggled, check your monitoring system to ensure the alarm is being monitored and enables when toggled.

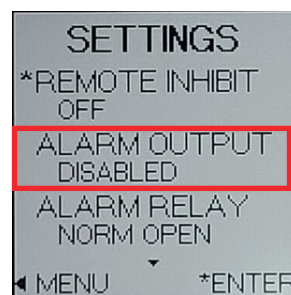

Alarm Relay

For the alarm output, the user has the option of selecting the relay to be normally open or normally closed. Select which option best suits the monitoring needs. In the Settings menu, scroll down to get more choices.

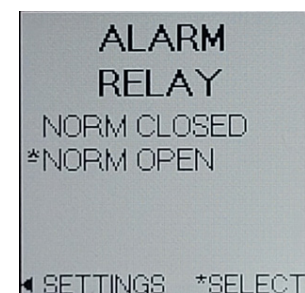
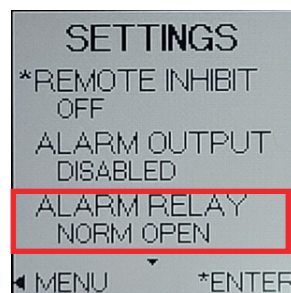

Alarm Sources

Selecting Alarm Sources will open a sub-menu to select the alarm sources in which to be notified. The two alarm options are Battery Low and Solenoid. The selected alarm will be highlighted with an asterisk (*). Navigate to each alarm in the list and press the navigation button in to select or deselect each option. If an alarm source is activated, it will have a single line dash (-) next to the alarm.

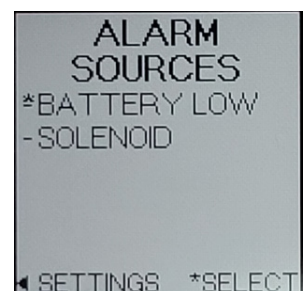
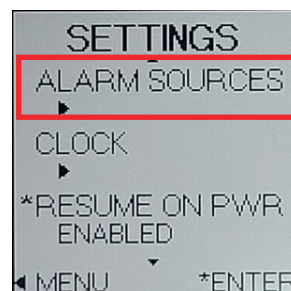

SECTION 3: SYSTEM CONTROL AND ELECTRONICS

Battery Low

The Battery Low alarm is an indication the battery voltage is low and should be replaced. If enabled, the Relay Output will be deactivated. The remaining battery capacity is dependent on the settings and ambient temperature the system is installed. The more often the pump is actuated with ambient temperatures approaching minimum or maximums of the operating range will result in considerably shorter battery capacity.

Solenoid

The solenoid alarm is an indication the solenoid fuse (F1), needs to be replaced.

A low supply voltage could also cause a solenoid alarm. If replacing fuse (F1) does not remove the solenoid alarm, verify supply voltage is within the required operating range using the Battery Test function.

NOTE: The battery test function can also be used to verify external supply voltage. If these steps do not remove the solenoid alarm, please contact YZ System Tech Support for help.

Clock Menu

Use the Clock Menu to set the day and time. Keeping the date and time accurate will keep the daily pumped usage total accurate. Before setting the time and date, choose which format you would like for each. The time can be formatted in a 12- or 24-hour clock. The date can be formatted in three ways (YYYY/MM/DD, DD/MM/YYYY, or MM/DD/YYYY). After selecting the formats for each, return to the Set Time option and press the navigation button in to enter. Entering the Set Time submenu allows you to set each individual parameter of the date and time. Use the left and right arrows to navigate to each digit in each parameter. An arrow will be shown under the digit and pointing up indicating which digit is being modified.

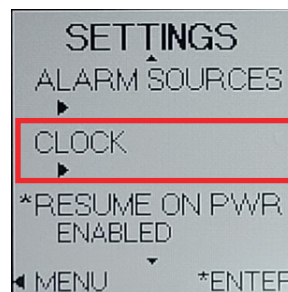

SECTION 3: SYSTEM CONTROL AND ELECTRONICS

Date & Time Set

Press the navigation button up or down to adjust the digit and press the navigation button to the right to move to the next digit. Setting the time and date can be cancelled by pressing the navigation button to the right until reaching the Back option highlighted with two asterisks (*). Press the navigation button in to enter and go back without saving. Once the time is set to the current time, navigate to the Save option at the bottom of the screen by pressing the navigation to the right until Save is highlighted with two asterisks (*). Press the navigation button in to enter the time.

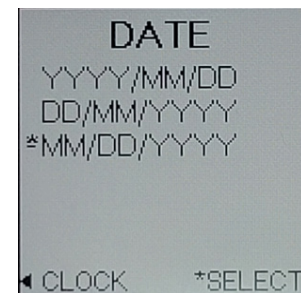
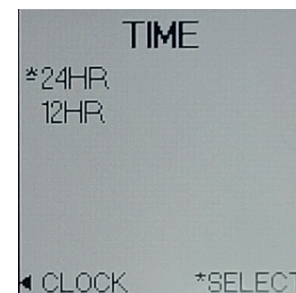
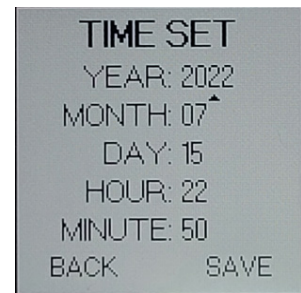

Resume on Power Loss

If the pump system loses power during normal operation, the Resume on Power loss function can be enabled so the system resumes pumping when power is returned. If the unit is not running when it loses power, it will stay not running.

To enable, open the Resume on Power Loss sub-menu. The highlighted option will be indicated with an asterisk (*) to the left of the option. To enable or disable, navigate to the preferred option and press the navigation button in to select.

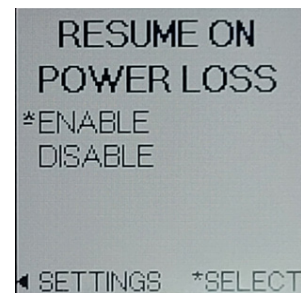
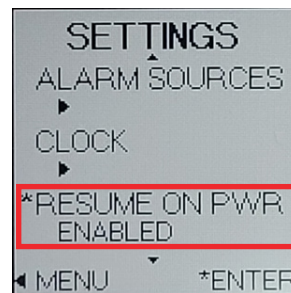

In the Settings menu, scroll down to get more choices.

Units

The Z-100 can be assigned either English or Metric units. Navigate to the Units submenu and press the navigation button in to enter. The highlighted set of units will be indicated with an asterisk (*) on the left side. The set of units that is selected and active will be indicated with a single line dash (-) on the left side. To change the units, navigate to the set of units that is preferred and press the navigation button in to enter the selection.

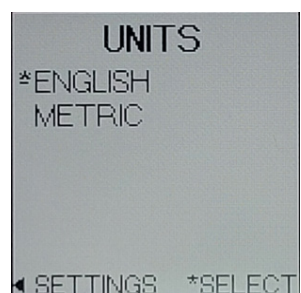
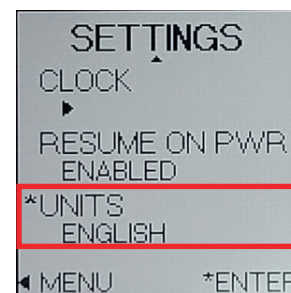

SECTION 3: SYSTEM CONTROL AND ELECTRONICS

Go back to Main menu and scroll down to Logs tab and press Enter.

Logs

The Z-100 logs the daily pumped usage for the pump system and saves to the controller locally. The data can be downloaded with an MM-100 Memory Module or it can be viewed directly on the controller. To view the logged data, open the Main Menu and scroll to the Logs option and press the navigation button in to open.

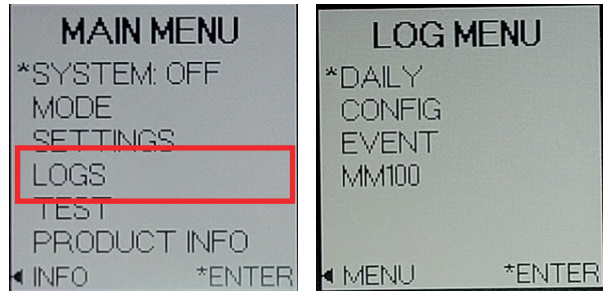

DOU

The DOU logs are the daily pumped volume logs. Select the DOU option by pressing the navigation button in. This will open the latest DOU log. Note the small arrows displayed on the bottom and/or top of each DOU screen. Scroll up or down to view logs from other days.

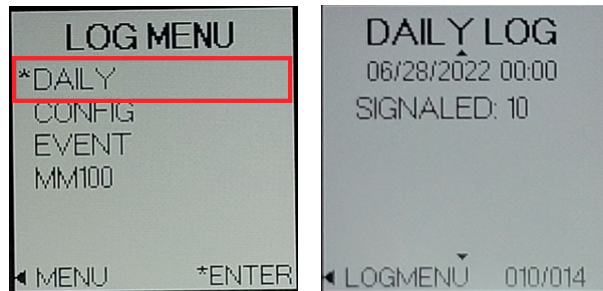

Config

The config logs are logs of changes to the system configuration. Changes that are saved include settings that affect the system performance such as a stroke rate change, changing of the operational mode, input signal type change, and alarm changes.

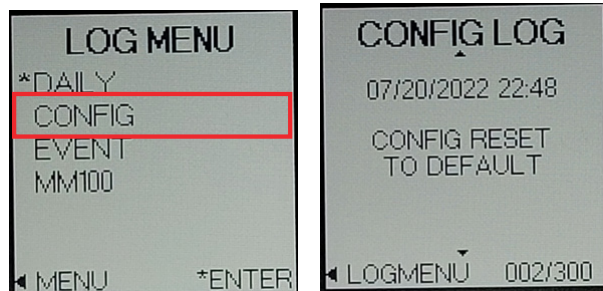

Event Logs

Event logs are saved when an event happens in the Z-100 controller. The events that are recorded are totalizer resets, DOU reset, alarm count reset, device powered on, alarms turning on or clearing of alarms, alarm output turned on or off, and time changes.

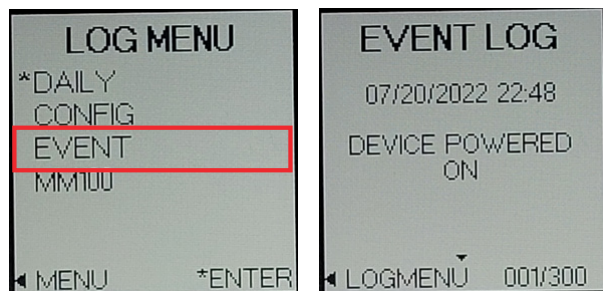

SECTION 3: SYSTEM CONTROL AND ELECTRONICS

MM100

When ready to download the MM-100 Memory Module data, connect the memory module in the opening in the bottom of the enclosure. A rubber plug is provided to protect the opening when not in use. If the MM-100 is not plugged in or not recognized, the MM100 screen will display "Not Found". If MM-100 is plugged in and recognized, you can download the module from the MM-100 screen. Go back to Main menu and scroll down to Tests tab and press Enter.

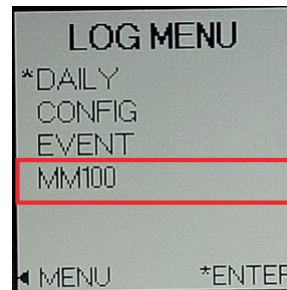

Test Menu

The test screen allows you to test the system functionality after installation or maintenance to ensure it is running as expected. To open the test screen, navigate to the Test option from the Main Menu and select the Test option by pressing the navigation button in to enter.

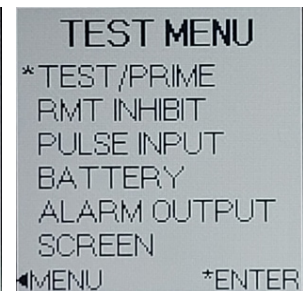
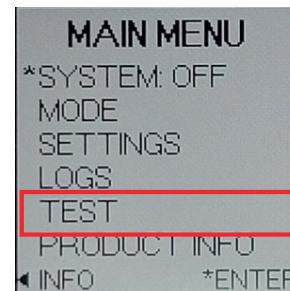

Test/Prime

The Test/Prime screen provides access to two functions. Function 1, press enter on the navigation switch the UP direction for 1 to 2 seconds will actuate the solenoid a single time to stroke the C-44 pump. Function 2, pressing the center button will initiate a prime cycle. The Prime cycle actuates the pump at a 2.5 second cycle time for 60 cycles, or until stopped by pressing the center button. The pump actuations signaled will increment each time the pump is stroked. This allows the system to be primed during installation and maintenance. For Cyclone systems "SENSED" will always show N/A.

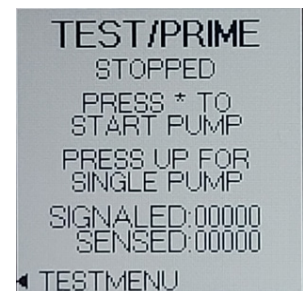
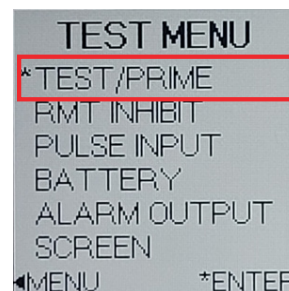

SECTION 3: SYSTEM CONTROL AND ELECTRONICS

RMT Inhibit

The INHIBIT TEST can be used to verify the incoming remote inhibit signal is being properly read by the Z-100 controller at the NBS IN (Remote Inhibit) input terminal.

If the REMOTE INHIBIT input setting is OFF, the test function will be disabled and TEST status NA displayed. Go to the SETTINGS MENU to change the REMOTE INHIBIT input setting.

If the REMOTE INHIBIT input setting is ON or NBS, upon entry, the INHIBIT TEST screen will show the INHIBIT test type (INHIBIT ON, or INHIBIT NBS) with NOT TESTING status. Press enter on the navigation switch to start the test and begin monitoring the NBS IN input.

If an active input signal is not sensed, the red LED will flash and the test status will indicate INPUT INACTIVE. If an active input signal is sensed the GREEN LED flash and the test status will indicate INPUT ACTIVE.

The difference between INHIBIT input types INHIBIT ON and NBS is the “active” voltage level of the incoming signal.

To stop the INHIBIT INPUT test press enter on the navigation switch.

Pulse Test

The PULSE TEST can be used to verify the incoming pulsed flow signal is being properly read by the Z-100 controller at the COUNT input. The PULSE TEST signal will be interpreted based on the PULSE TYPE setting for COUNTER mode. To test the pulse signal, ensure the type of pulse is selected from the Mode Menu when the Counter mode is selected. The pulse types are voltage, or dry contact/SSR.

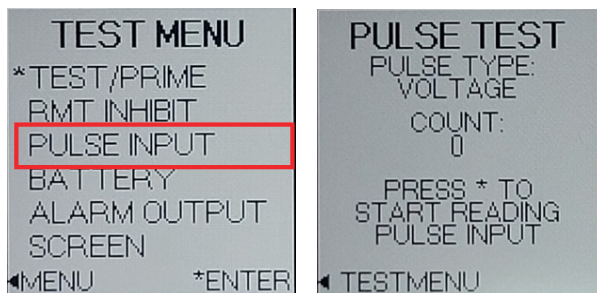
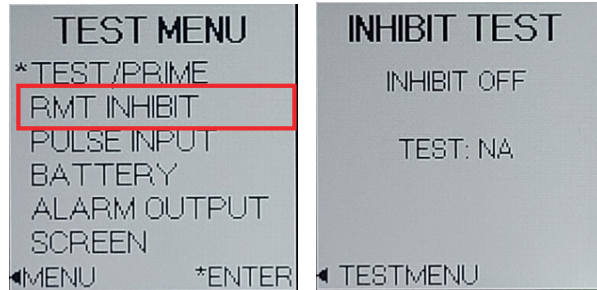

SECTION 3: SYSTEM CONTROL AND ELECTRONICS

Navigate to the Pulse Input option from the Test Menu screen and press enter on the navigation switch to select. The Pulse Test screen will display what pulse type is selected. Press enter on the navigation switch to enter and start reading the pulse input. Send the pulse signal from the signal generator and confirm the counts on the Z-100 controller. The count will increase and the green LED will flash on every successful pulse reading.

Battery Test

The BATTERY TEST is used to verify the system power supply voltage read by the controller. The test is primarily used when to verify the voltage when the system is powered from the internal battery pack. The test can also be used to verify the voltage reading when the system is supplied by and external power source.

Select BATTERY TEST from the Test Menu and press enter on the navigation switch. The BATTERY TEST screen will open. The value shown initially will be from the previously run test and not a current reading. In order to get a valid test result, a solenoid must be connected to the system. Press enter to start the test, the solenoid will be actuated one time, the LED will flash and the battery voltage reading will be updated. A new battery will read approximately 11.5V during this test and the LED will flash GREEN. If the battery voltage is found to be low during the test, the LED will flash RED. A fully charged new battery pack will measure approximately 14.4V if measured with a DMM or voltmeter at the battery leads.

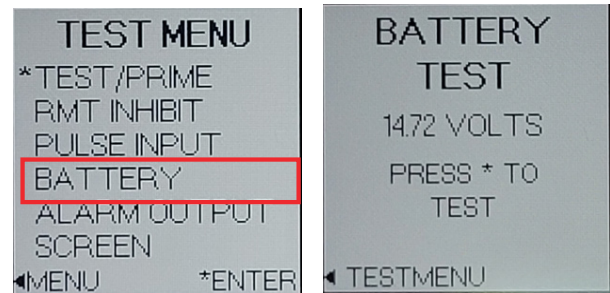

SECTION 3: SYSTEM CONTROL AND ELECTRONICS

Alarm Output Screen

The RELAY OUTPUT test is used to the RELAY OUTPUT is being properly sensed by the users external SCADA or other control system.

If the RELAY OUTPUT setting is DISABLE, the test screen will indicate RELAY OUTPUT NOT CONFIGURED, CHECK SETUP. Change the RELAY OUTPUT setting to enable the output and test. If RELAY OUTPUT setting is ALARM OUT, the test display will show the relay config as ALARM OUT, the normal contact state, and ALARM OFF. Press enter to toggle the alarm ON or OFF and OPEN or CLOSE the output relay.

If RELAY OUTPUT setting is SAMPLING RATE, the test display will show the relay config as SAMPLING RATE, and normal output state. Press enter to initiate a single 40mS output pulse. The LED will flash GREEN to indicate the pulse was generated.

Screen Test

The Screen Test will cycle all pixels on the display on (black), then all off (blank), then back to the Test Screen. This test can help determine if any pixels are malfunctioning on the display.

Z-100 Product Info

Go back to Main menu and scroll down to product info tab and press Enter to show the product information.

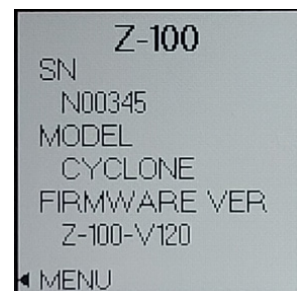
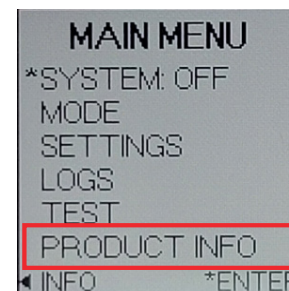
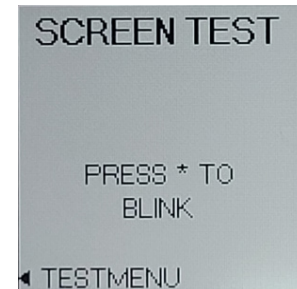
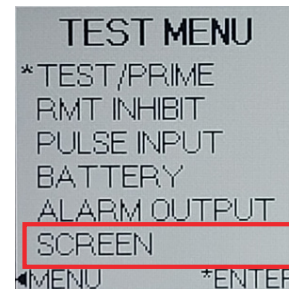
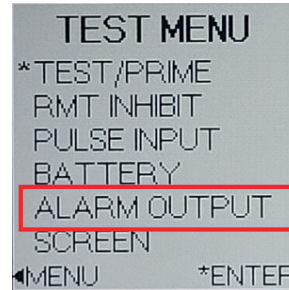

SECTION 3: SYSTEM CONTROL AND ELECTRONICS

Selecting the Z-100 Operational Mode

The Z-100 controller can operate your Cyclone system in timer mode or counter mode. To select the Z-100 mode of operation, navigate to the Main Menu and select Mode. The Mode Menu will open showing the currently selected operating mode and mode specific settings.

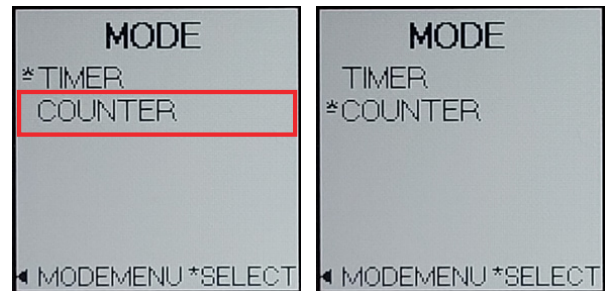

Select Mode to access the list of modes available an * indicates the currently selected mode. Once a mode has been selected, press the left key to exit back to the Mode Menu.

Go back to Mode menu and under Mode menu scroll down and select Counter tab and press enter.

Timer Mode

In timer mode, the controller actuates the C-44 pump at a set time interval as per the CYCLE TIME setting. The CYCLE TIME range is 0.1 hr to 100.00 hr in 0.01 hr increments. To modify the CYCLE TIME, move the * to CYCLE TIME and press enter to select. Use the navigation switch to modify the value then navigate to SAVE and press enter.

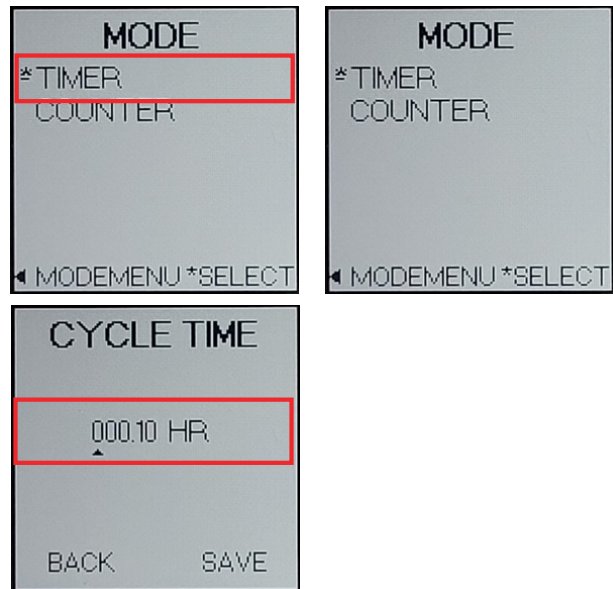

SECTION 3: SYSTEM CONTROL AND ELECTRONICS

Counter Mode

In counter mode, the Z-100 controller functions as a pulse divider. The controller monitors and counts a customer provided pulse signal at the COUNT input. When the number of pulses counted equals the PULSE DIVIDER setting the controller actuates the C-44 pump. The PULSE DIVIDER can be set from 1 to 10,000 in increments of 10. When the counter mode is selected, the PULSE DIVIDER setting will determine the pumps injection rate in response to the incoming pulses. For example, a pulse divider of 10 will cause the pump to actuate once each time 10 pulses are counted. The minimum pulse width is 20ms with a maximum input frequency of 25Hz. The pulse types available are Voltage or Dry Contact/SSR. Navigate to the Pulse Type option submenu. Select the pulse type and navigate to the select button and press enter to save.

Pulse Types:

Voltage: Positive voltage pulse (5-24VDC).

Dry/SSR: Voltage free contact closures.

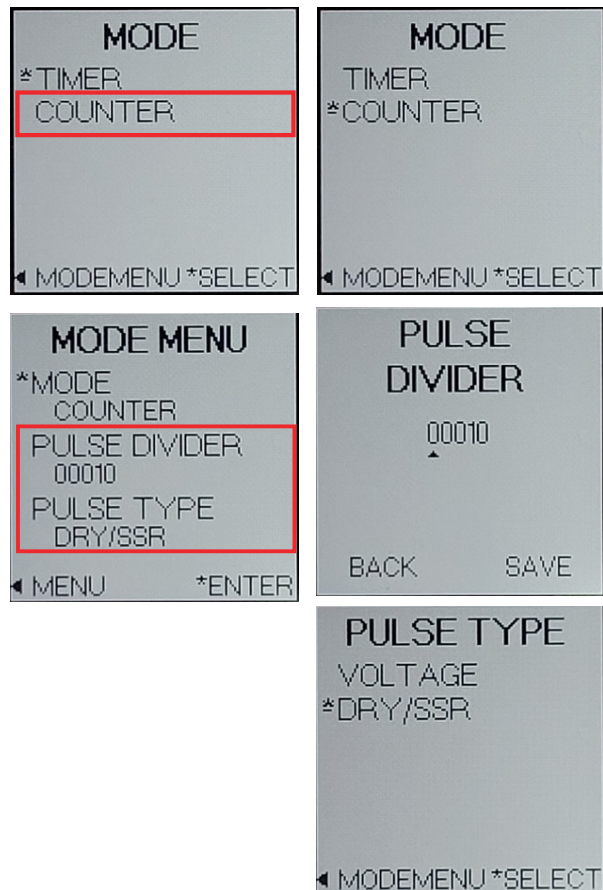

SECTION 3: SYSTEM CONTROL AND ELECTRONICS

Z-100 Set-up Proportional-to-Flow

Calculate the counter setting using the following chart:

1. C-44 pump displacement (.140cc) = a. _____
2. Desired injections lubricant per volume of flow (cc/MMCF or cc/MCM) = b. _____
3. pulses/volume metered (pulses/MMCF or pulses/MCM) = c. _____
4. Counter setting = (a x c) / b

		Example#1 English Gas Flow Units	Example#2 Metric Gas Flow Units
Pump Displacement	(a.) =	.140cc	.140cc
Injection Rate	(b.) =	.05cc/MMCF	.05cc/MCM
Pulses per volume metered	(c.) =	100 pulses/MMCF	100 pulses/MCM

Example #1

Counter Setting = (.140cc X 100 pulses per MMCF) / .05cc per MMC = 280 pulses

Example #2

Counter Setting = (.140cc X 100 pulses per MCM) / .05cc per MCM = 280 pulses

IMPORTANT NOTE:

If the calculated counter setting is less than 10 or greater than 9900, the pulses per volume metered will need to be adjusted. This can be programmed in most flow meters to the desired rate. If the calculated counter setting is less than 10, increase the pulses per volume metered. If the calculated counter setting is greater than 9900, decrease the pulses per volume metered.

SECTION 3: SYSTEM CONTROL AND ELECTRONICS

Z-100 Set-up Proportional-to-Time

Go back to Mode menu and under Mode menu scroll down and select Timer tab and press enter.

Timer Mode

The Z-100 controller sends a signal to the solenoid to actuate the pump at a set time interval. The cycle time must be selected. The cycle time is 0.10 hr.

Calculate the injection rate using the following 30 day chart.

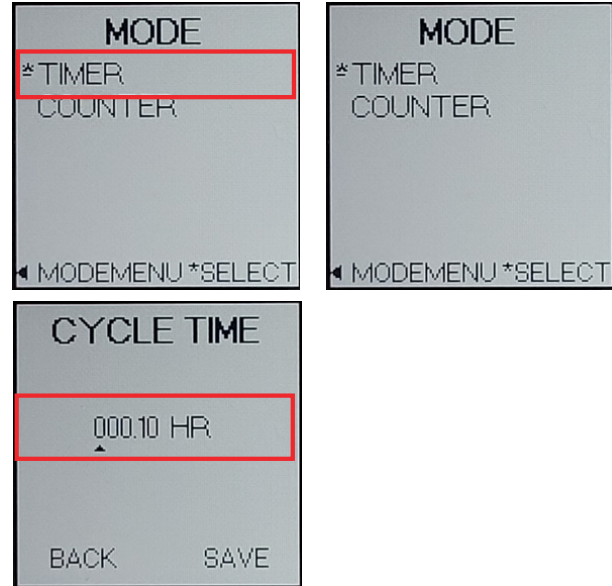

Counter Range Settings

cc/month	Hours	cc/month	Hours
1	100.8	15	6.7
2	50.4	20	5.0
3	33.6	25	4.0
4	25.2	30	3.4
5	20.2	40	2.5
6	16.8	50	2.0
7	14.4	60	1.7
8	12.6	75	1.3
9	11.2	100	1.0
10	10.1		

SECTION 3: SYSTEM CONTROL AND ELECTRONICS

Operation Check and Leak Testing

- When all of the tubing connections have been completed, open the gas supply valve to allow pipeline pressure into the injector. Check all connections using a liquid leak detector.
- Adjust the filter/regulator from the following ranges.
- Allow the injector to operate until oil is present at the purge orifice on the protector, then close purge nut.
- Allow the injector to operate until pressure begins to build on the protector gauge. STOP unit promptly. Do not allow pressure to exceed 1000 psi.

Pipeline, in psi	Actuation, in psi
15-50	(no regulator required)
50-200	35
200-500	40
500-800	45
800-1200	50
1200-1500	55

- Open the Cyclone protector isolation valve.
- Open the meter isolation valve.
- Allow the injector to operate until pipeline pressure is achieved at the injector discharge.
- Push * to stop pumping.
- Check all connections from the injector discharge to the connection on the meter for oil leaks.
- If no leaks are found, the pump and tubing should be considered tested and functional.
- Fill oil reservoir with desired quantity of lubricant (Anderol, Chemlube or 5W equivalent). The reservoir has a 6 oz. capacity.
- Verify isolation valve on protector is closed.
- Open purge nut on protector approximately 1 turn.

- Go to Main Menu, scroll down to Test and push to choose TEST.
- From the TEST MENU, choose TEST/PRIME. Notice it gives status: STOPPED. Press * to start pumping. The controller will signal the solenoid about every three seconds. You should see the LED flashing and hear the Solenoid stroking.

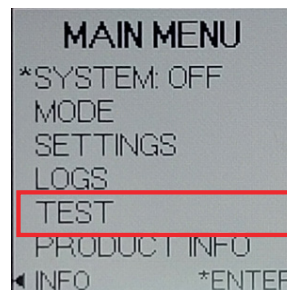

SECTION 4: INJECTOR MAINTENANCE

Recommended preventative maintenance schedule

Every injection situation is unique. Below are our recommendations for average conditions. High injection rates will necessitate more frequent pump/filter maintenance.

- Clean and inspect injector pump biannually.
- Check the filter element every six months, replacing as necessary.
- Test the battery every month.
- Test the system for leaks each time a fitting or connection has been made.

Recommended spare parts for the Cyclone 4400 MLS

Part Number	Description	Qty	Location
C4-0004	Filter Element	1	see diagram
D3-0156	C-44 pump seal kit	1	see diagram
D3-0003	YZ filter regulator repair kit	1	see diagram
D3-0284	Z-100 fuse replacement kit	1	see diagram
E3-2005	Battery pack	1	see diagram
A4-0036	Solenoid	1	see diagram
C7-0009	3mm Tubing	as req'd	see diagram

SECTION 4: INJECTOR MAINTENANCE

Pump Rebuild - Disassembly

- Go to Main Menu, then System, and select OFF.
- Close isolation valves from pipeline and to meter.
- Open the Purge Nut on the protector to relieve pressure.
- Remove discharge tubing.
- Remove reservoir drain plug, and drain the oil.
- Disconnect the actuation line from the actuation cylinder.
- Unscrew the actuation cylinder from the pump body.
- Remove plunger and piston from the actuation cylinder.
- Insert a 8-32 bolt into the threaded hole in the seal cartridge; pull up to remove cartridge. Inlet check valve wafer can now be removed from pump body.
- Remove discharge tubing fitting from pump body. Discharge wafer / spring can now be removed from pump body.
- Clean and inspect all components and replace if necessary.

Figure 7

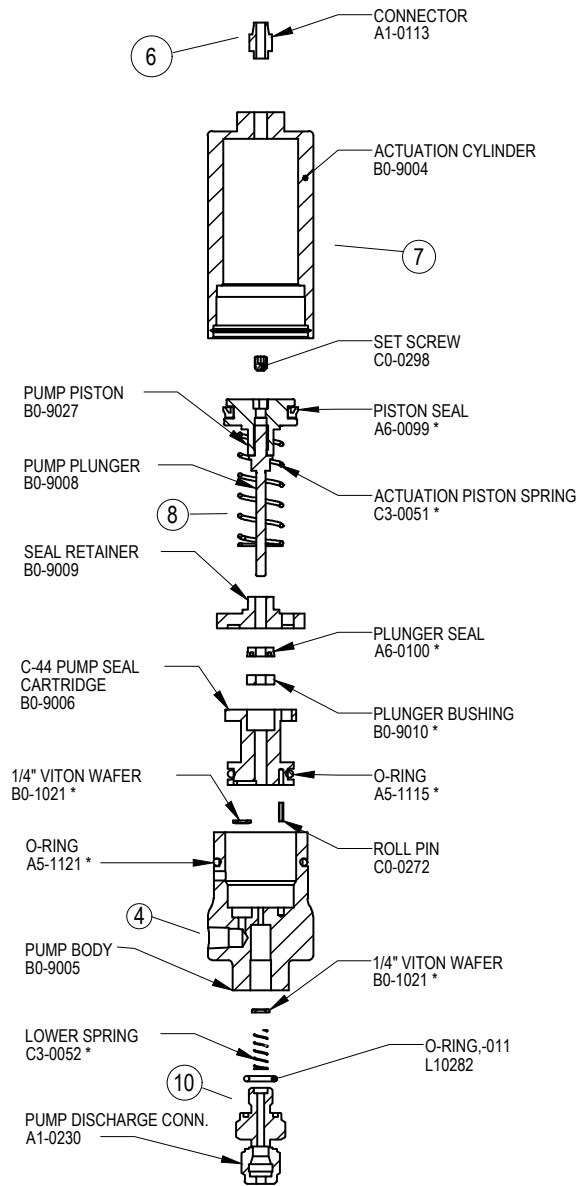

* C-44 Pump Seal Kit P/N D3-0156

SECTION 4: INJECTOR MAINTENANCE

Pump Rebuild - Assembly

1. Install ICV wafer into seat pocket in the pump body.
2. Install new seal, bushing and 015 O-ring in seal cartridge.
3. Apply light grease to 015 o-ring on seal cartridge. Orient alignment pin on cartridge with alignment hole in pump body. Install cartridge body.
4. Apply light grease to inside of actuation cylinder.
5. Install piston/plunger into actuation cylinder with spring attached.
6. Apply light coat of grease to top of plunger seal.
7. Place seal retainer on top of seal cartridge.
8. Install actuation cylinder/plunger assembly.
9. Install DCV wafer, spring and fitting.
10. Reconnect discharge tubing.
11. Refill reservoir to proper level with lubricant.
12. Reconnect actuation cylinder tubing line.
13. Prime system.

Figure 8

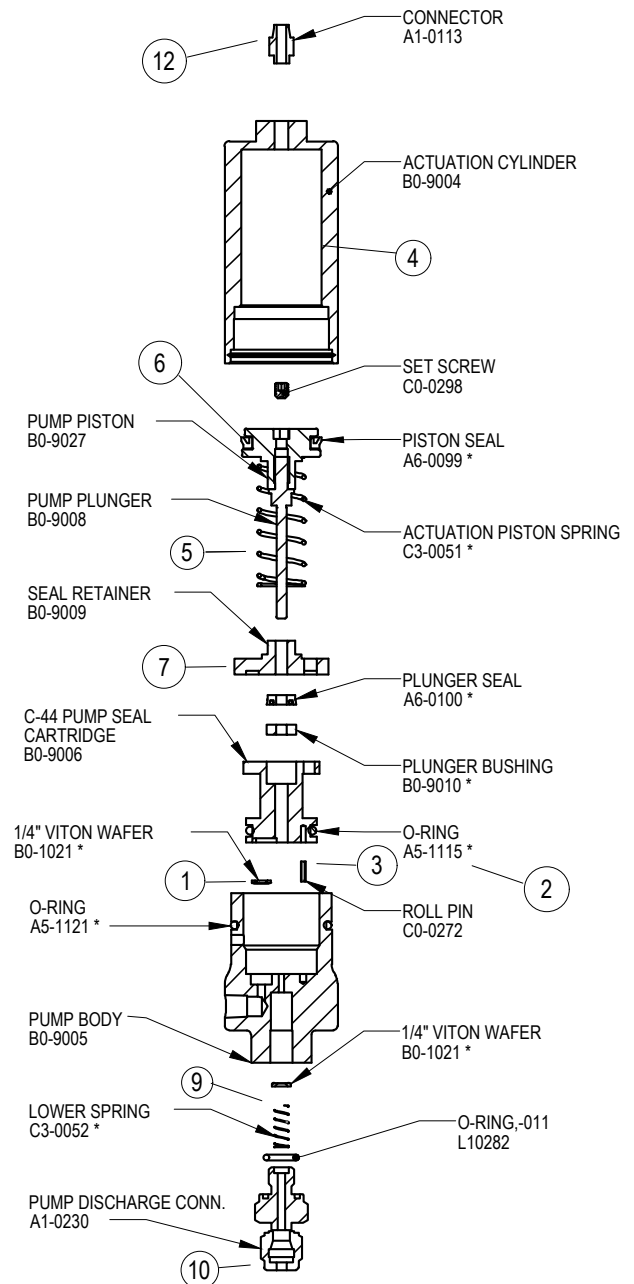

* C-44 Pump Seal Kit P/N D3-0156

SECTION 4: INJECTOR MAINTENANCE

Battery Test

The BATTERY TEST is used to verify the system power supply voltage read by the controller. The test is primarily used when to verify the voltage when the system is powered from the internal battery pack. The test can also be used to verify the voltage reading when the system is supplied by and external power source.

Select BATTERY TEST from the Test Menu and press enter on the navigation switch. The BATTERY TEST screen will open. The value shown initially will be from the previously run test and not a current reading. In order to get a valid test result, a solenoid must be connected to the system. Press enter to start the test, the solenoid will be actuated one time, the LED will flash and the battery voltage reading will be updated. A new battery will read approximately 11.5V during this test and the LED will flash GREEN.

If the battery voltage is found to be low during the test, the LED will flash RED. A fully charged new battery pack will measure approximately 14.4V if measured with a DMM or voltmeter at the battery leads.

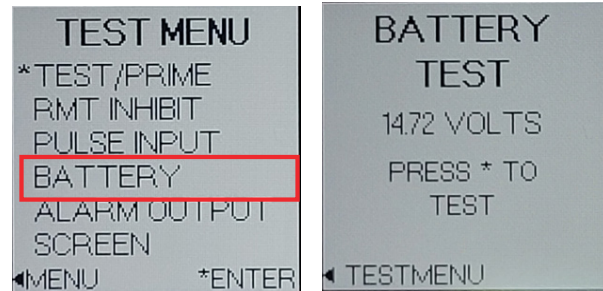

SECTION 4: INJECTOR MAINTENANCE

Replacing a depleted battery

- Remove the four thumb screws, cover plate and terminal connector.
- The battery is located in the upper right hand corner of the Z-100 controller assembly.
- Un-clip the battery plug from the battery receptacle.
- Replace the depleted battery with a fresh battery pack (part No. E3-2005).

IMPORTANT NOTE: Follow the illustration along with steps 1-5 to assure proper battery replacement in the Z-100 enclosure

- Restart the Z-100 controller.
- For Technical Support: 1-281-362-6500
1-800-NJEX-HELP
(1-800-653-9435)
Email: techsupport@yzsystems.com

Figure 9

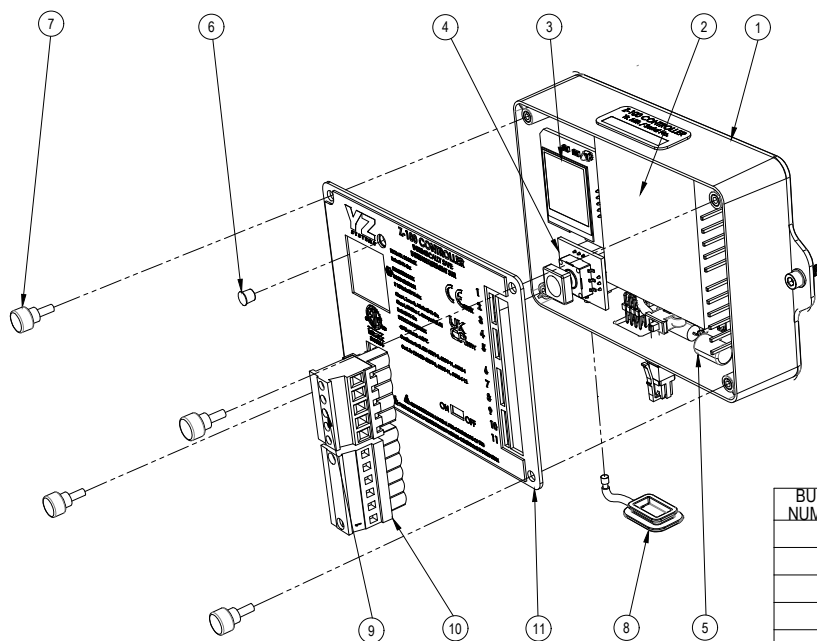

BUBBLE NUMBERS	PART NO.	DESCRIPTION
1	F2-0615	Z-100 Controller Assy
2	E3-2005	Battery Pack
3	G0-0096	Z-100 Display Board
4	G0-0097	Z-100 Navigation Switch
5	D3-0284	Z-100 Fuse Replacement Kit (2 Fuses per kit)
6	C0-1026	Stand Pipe
7	A9-1001	Thumb Screws
8	D5-0322	Z-100 MM Plug Cover
9	H1-0201	Z-100 5 Pin Terminal Block
10	H1-0202	Z-100 6 Pin Terminal Block
11	A9-3141	Z-100 Face Plate

SECTION 4: INJECTOR MAINTENANCE

Solenoid Maintenance

Figure 10

- The solenoid assembly A4-0038 is made up of the solenoid A4-0036 and the manifold C1-0614. To replace the solenoid, remove only the two slotted head bolts as shown in figure. Removing any other screws to disassemble the solenoid voids the certification of the solenoid.
- For Technical Support:
1-281-362-6500
1-800-NJEX-HELP
(1-800-653-9435)
Email: techsupport@yzsystems.com

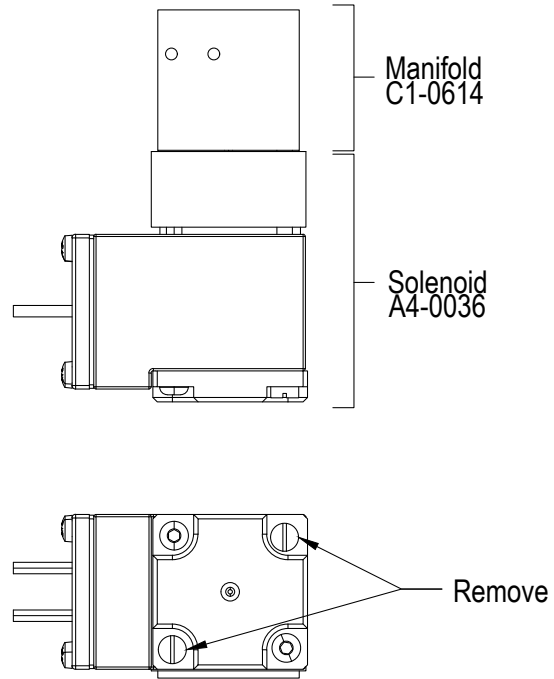

SECTION 5: TROUBLESHOOTING

How to Use This Section

The recommendations contained in this section should be used as a preliminary information resource to remedy operational issues with the Cyclone System. It is important to read all of the definitions and notes prior to initiating work.

Each subsection contains a description of the indicators followed by a step-by-step trouble shooting procedure.

For Additional Help

Any issue that can not be resolved through the use of this reference, please contact YZ:

For Technical Support:

1-281-362-6500 &
1-800-NJEX-HELP
(1-800-653-9435)

Email: techsupport@yzsystems.com

SAFETY NOTES

- Always use extreme care when performing maintenance on Sampling Systems. Always take necessary measures to assure that electrical classification in the area is considered, before, and during all repairs, and that necessary steps are taken to maintain proper electrical procedures for the classification of the area.
- Take special care when disconnecting any fitting, to assure that product and/or pressure will not be released when the connection is broken. This system may contain liquid and/or gas high pressures.

Step-by-Step Resolution

Using a step-by-step method to resolve issues on the Sampling System will reduce maintenance time and assist in returning the system to service quicker.

The following represent the recommended chronology to resolve issues:

Resolve issues to the following order:

- a. Battery Power, [page 37](#)
- b. Timer Mode, [page 37](#)
- c. Counter Mode, [page 38](#)
- d. Mechanical Assembly, [page 39](#)

SECTION 5: TROUBLESHOOTING

Battery Power

The Z-100 controller and the low powered solenoid are normally powered by the Z-100 battery assembly. The battery assembly is not a rechargeable type battery. Under normal conditions this battery may last two years. The Z-100 controller has an alarm that will advise when the battery needs replaced.

Battery Power Troubleshooting Steps

- The battery voltage can be tested with the battery test option under the test menu. Navigate to the battery test menu and press enter on the navigation switch.
- While in the battery test menu, press the navigation switch in to test the battery

NOTE: The battery test will send a signal to the solenoid to stroke the pump - the pump will stroke into the discharge line if open. This provides the most accurate load on the battery pack to be representative of the available battery life.

- The battery voltage will be displayed on the screen and the LED will flash green or red, depending if the battery voltage is acceptable or low. It is recommended to replace the battery when it reaches 11.5 volts as shown on the controller in the battery test screen with the solenoid connected.

Trouble Shooting: Timer Mode

If the display looks like it is missing sections or stray marks, run the screen test.

Screen Test

- Set the mode to Timer.
- This mode enables the user to increase the solenoid output rate at a set time interval.
- Go to Main Menu, scroll down to TEST and push to choose TEST.
- Scroll down to SCREEN. Push to choose that.
- Press once and the screen should go to all black, then all white. It's fast - you can repeat it to double check. Push left to return to test.

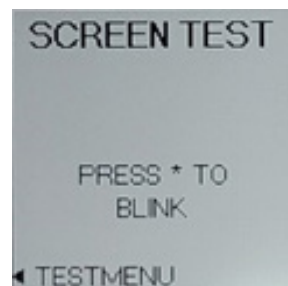
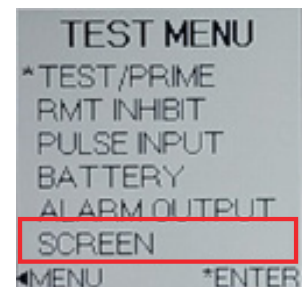
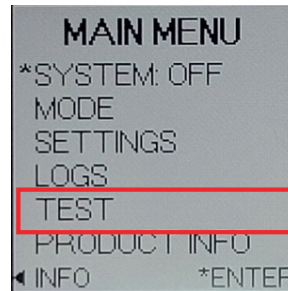

SECTION 5: TROUBLESHOOTING

Trouble Shooting: Counter Mode

Go back to Mode menu and under Mode menu scroll down and select Counter tab and press enter.

The Z-100 controller monitors a pulse input signal provided by the customer. In this mode, the Z-100 controller is used as a dividing counter to control the rate at which the solenoid output is activated to stroke to the pump. When the counter mode is selected, the pulse divider must be input to determine how often the pump will stroke in response to the incoming pulses. Navigate to the Pulse Divider option and press the navigation button in to enter the Pulse Divider screen. The arrow at the bottom of the number will indicate which digit is being modified. Press the navigation button up or down to adjust the digit and then press the right arrow to move to the next digit. Use the right arrow to navigate to the back button and press the button in to cancel, or navigate to save and enter to save. The pulse types that can be selected are Voltage or Dry Contact/SSR. Navigation to the Pulse Type option from the Mode Menu to open the Pulse Type submenu. Select the pulse type and navigate to the select button and press enter to save, or press the navigation button to the left to discard the change.

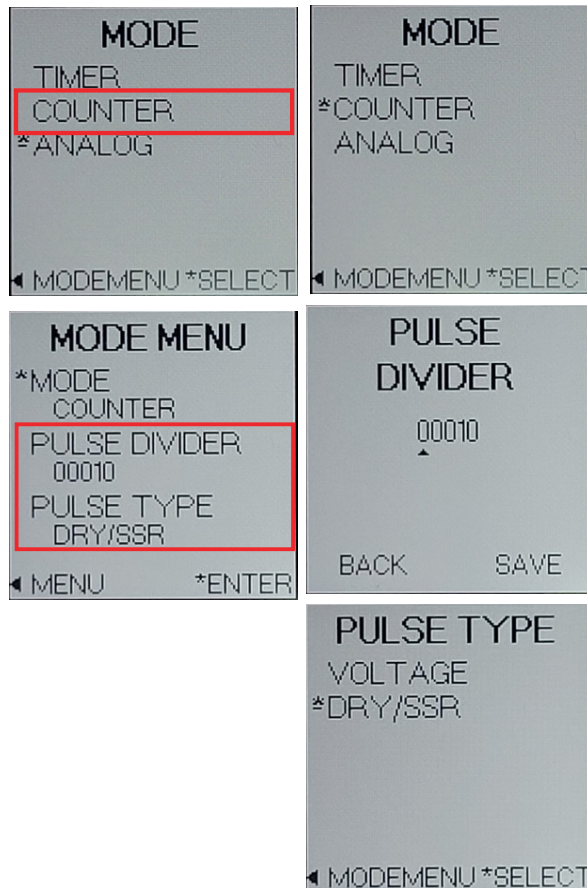

Fuse Replacement

- If the Z-100 display will not power-up, from battery or external power supply, replace F2.
- If the Z-100 powers up, but the solenoid does not activate, replace F1.

SECTION 5: TROUBLESHOOTING

Mechanical Assembly

Figure 11

- The basic mechanical components of the Cyclone 4400 MLS are:

- C-44 Pump
- Calibration Oil Reservoir/Actuation Manifold
- Filter Regulator
- Solenoid and Manifold

- Should malfunction of the mechanical system be suspected, follow the following procedure:

- System actuation pressure: absolute minimum requirement is 15 psi. Refer to chart located on page 13 for actuation requirements.
- Oil level: must be visible in reservoir.
- Pump action: pump stroke and actuation gas vent should be audible when actuated with test button on Z-100 controller. Follow diagram to test system.

IMPORTANT NOTE:

Follow the illustration to assure proper battery wire placement in the Z-100 enclosure.

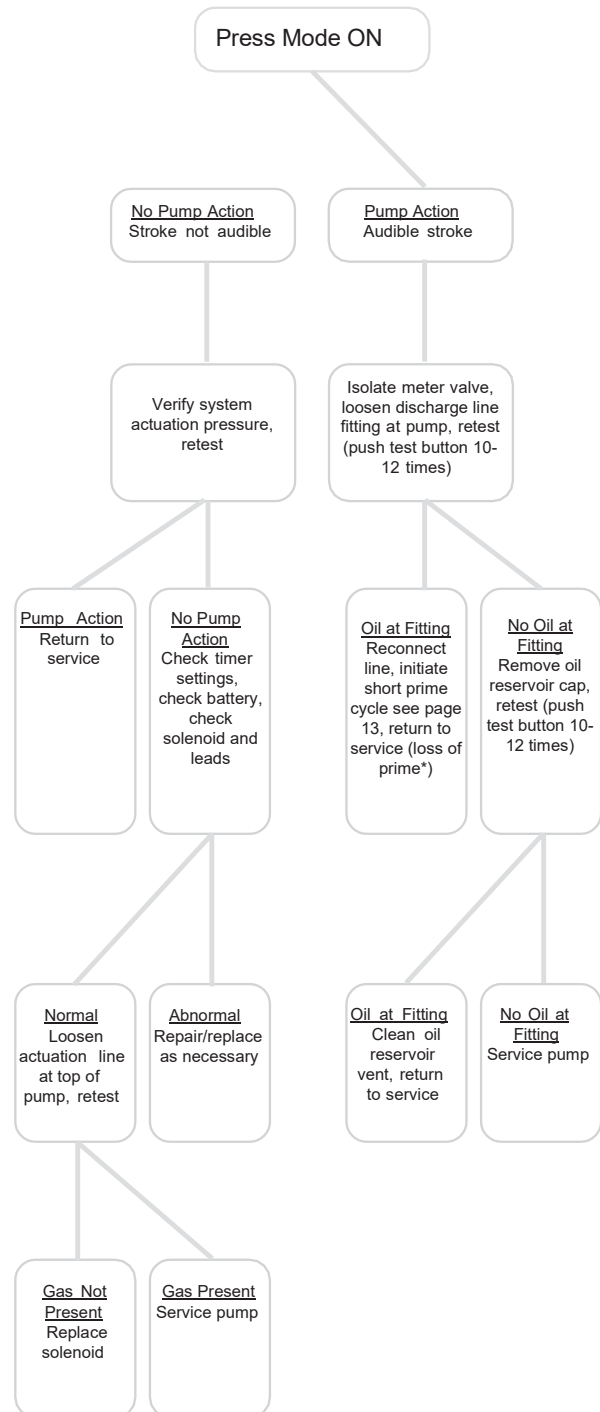

APPENDIX A: ILLUSTRATIONS

C-44 Pump Assembled

Figure 12

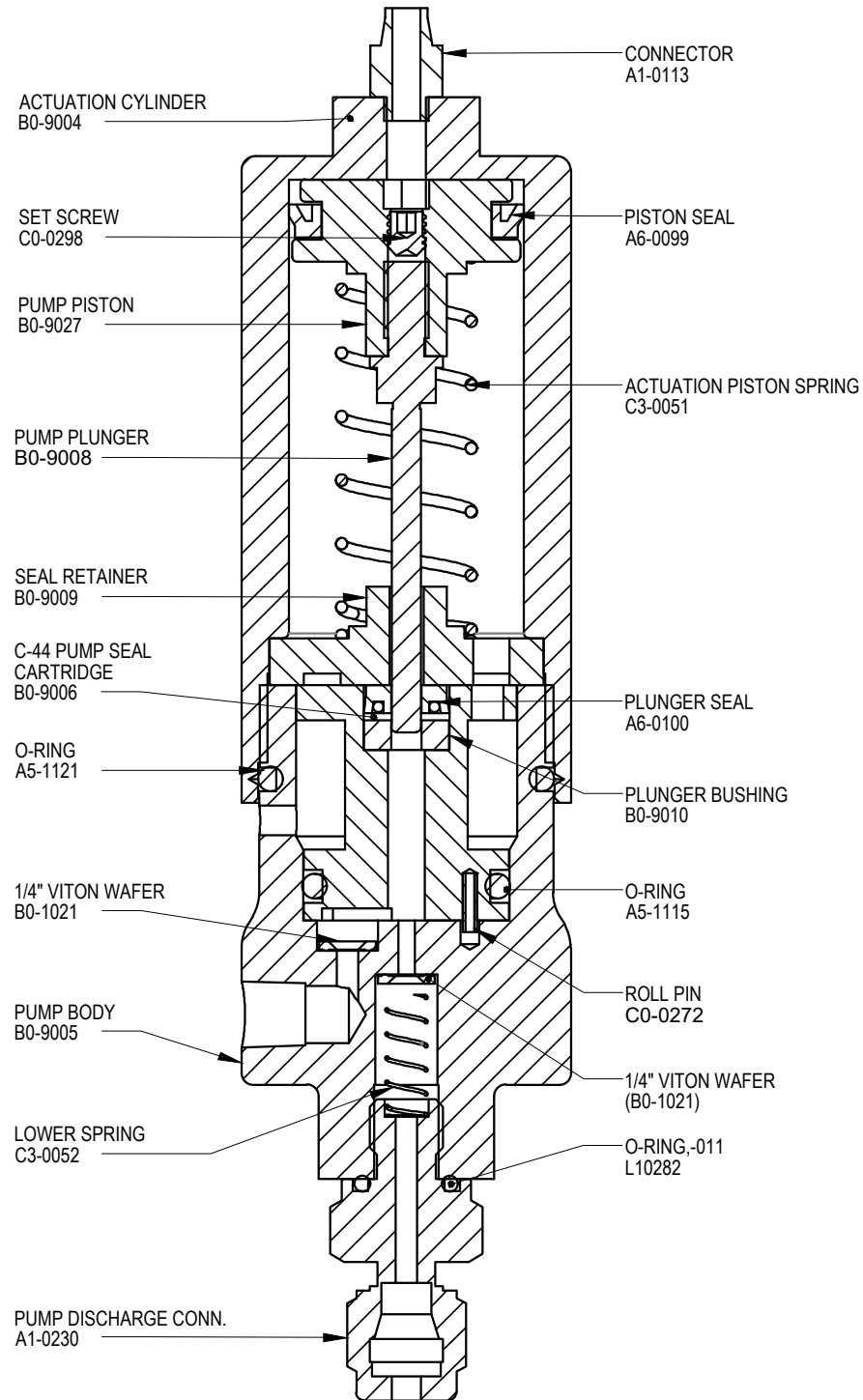

APPENDIX A: ILLUSTRATIONS

C-44 Pump Exploded

Figure 13

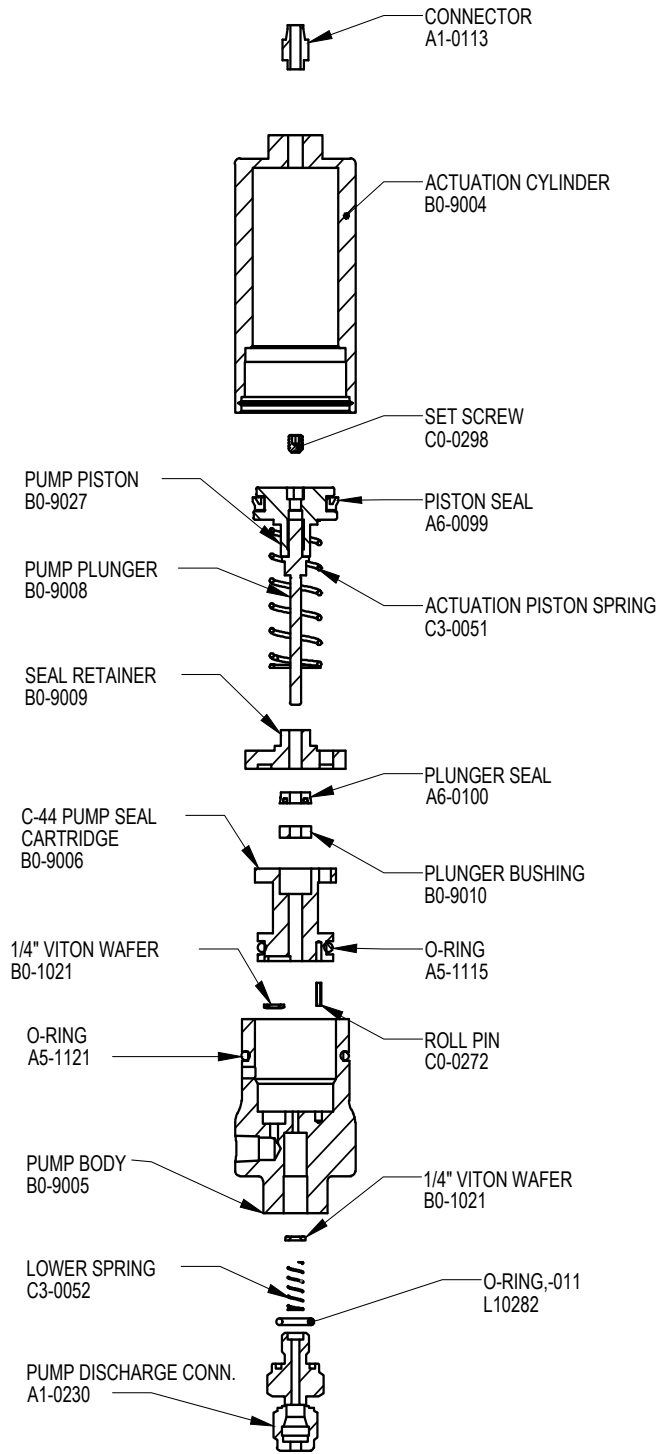

APPENDIX A: ILLUSTRATIONS

YZ Filter / Regulator Assembled

Figure 14

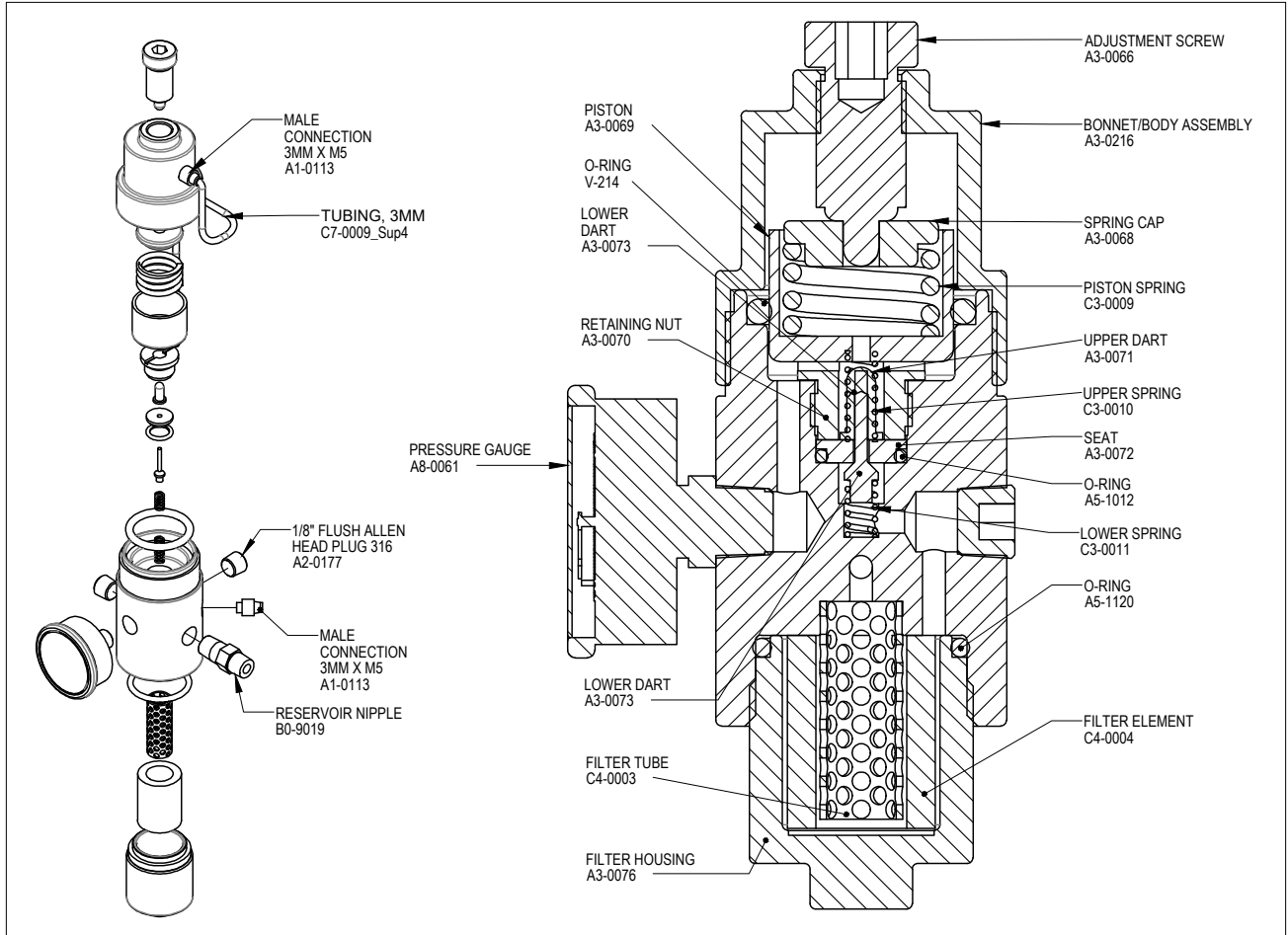

APPENDIX A: ILLUSTRATIONS

Z-100 Controller

Figure 15

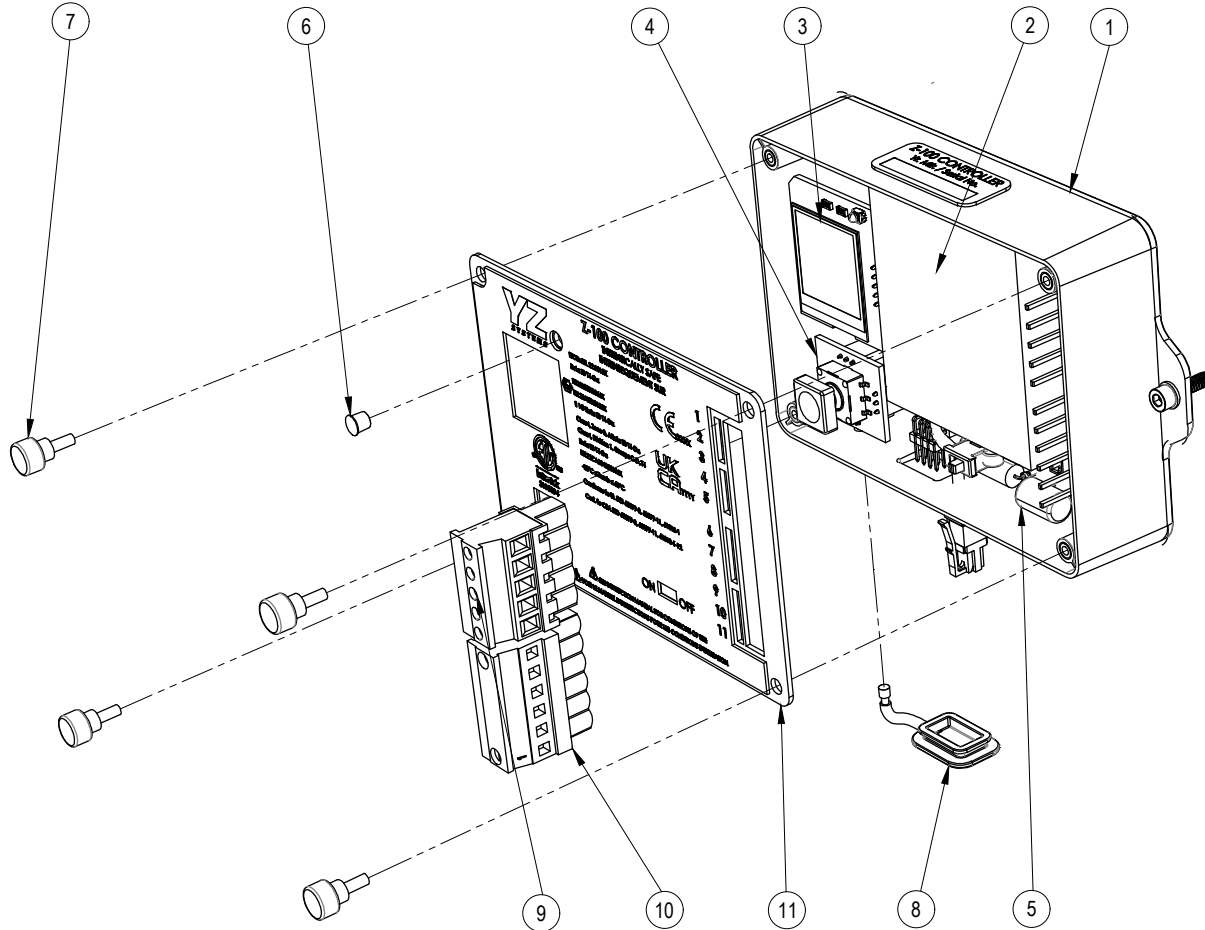

BUBBLE NUMBERS	PART NO.	DESCRIPTION
1	F2-0615	Z-100 Controller Assy
2	E3-2005	Battery Pack
3	G0-0096	Z-100 Display Board
4	G0-0097	Z-100 Navigation Switch
5	D3-0284	Z-100 Fuse Replacement Kit (2 Fuses per kit)
6	C0-1026	Stand Pipe
7	A9-1001	Thumb Screws
8	D5-0322	Z-100 MM Plug Cover
9	H1-0201	Z-100 5 Pin Terminal Block
10	H1-0202	Z-100 6 Pin Terminal Block
11	A9-3141	Z-100 Face Plate

APPENDIX A: ILLUSTRATIONS

Z-100 Installation Drawing

Z-100 ELECTRONIC CONTROLLER HAZARDOUS AREA INSTALLATION INSTRUCTIONS AND DRAWINGS

The following instructions apply to equipment covered by the following certificate numbers:

IECEX: IECEX ETL 22.0013X
 ATEX: ETL22ATEX0132X
 UKEX: ITS22UKEX0366X
 NORTH AMERICA: ETL22CA104230006X

APPLICABLE STANDARDS:

Class I, II, and III, Division 1, Hazardous (Classified) Locations
 UL 913:2013 Ed.8+R:06 Dec2019
 UL 60079-0:2019 ED.7 + R:15 APR 2020, UL 60079-11:2013 ED.6 + R:14 SEP2018
 CSA C22.2#60079-0 : 2019 ED.4, CSA C22.2#60079-11 : 2014 ED.2)(R2018)
 IEC 60079-0 : 2017 ED.7, IEC 60079-11 : 2011 ED.6
 EN 60079-0 : 2018, EN 60079-11 : 2012

The Z-100 controller assembly (F2-0615) is an intrinsically safe electronic controller that can reside in a hazardous area and is used to control and monitor chemical injection or sampling applications. The Z-100 also provides several entity rated intrinsically safe customer inputs and outputs. These include 2 digital inputs, 1 digital output, and 1 analog input for interfacing to suitably certified equipment located inside or outside the hazardous area.

The Z-100 Controller may be used in hazardous area locations with flammable gas and vapors of Class I group IIB Zone 0 or Division 1 Group C-D with a temperature class rating of T4 with an ambient temperature range of -20C to +60C.

Z-100 Intrinsically Safe Controller Assembly F2-0615, shall be housed in a general purpose enclosure with or without factory interconnect wiring and mechanical components. The minimum IP rating of the system enclosure shall be IP54.

For safe operation and installation the information in this document, and the end applications system level instruction and operating manual shall be observed.

The Z-100 Controller shall only be installed and maintained by qualified personnel in accordance with all local laws, national laws, directives, and standards applicable to the country and area of installation. Factory wiring shall not be modified.

02/16/2023	28238	PRODUCTION RELEASE	GSS	YZT	00
12/14/2022	26682	PRELIM: UPDATED ENTITIES, ADDED WARNING,	GSS	YZT	C
DATE	ECN	DESCRIPTION	UPD BY	APR BY	REV

REVISION HISTORY

COPYRIGHT © MILTON ROY, LLC THIS DOCUMENT IS THE PROPERTY OF MILTON ROY (MR). YOU MAY NOT POSSESS, USE, COPY OR DISCLOSE THIS DOCUMENT OR ANY INFORMATION IN IT, FOR ANY PURPOSE, INCLUDING WITHOUT LIMITATION TO DESIGN, MANUFACTURE OR REPAIR PARTS, OR OBTAIN ANY GOVERNMENT APPROVAL TO DO SO, WITHOUT MR'S EXPRESS WRITTEN PERMISSION. NEITHER RECEIPT NOR POSSESSION OF THIS DOCUMENT ALONE, FROM ANY SOURCE, CONSTITUTES SUCH PERMISSION. POSSESSION, USE, COPYING OR DISCLOSURE BY ANYONE WITHOUT MR'S EXPRESS WRITTEN PERMISSION IS NOT AUTHORIZED AND MAY RESULT IN CRIMINAL AND/OR CIVIL LIABILITY.

UNLESS OTHERWISE SPECIFIED:
 DIMENSIONS ARE INCH[mm]
 INTERPRET DIM AND TOL PER ASME Y14.5-2009
TOLERANCES:
 X ± .050[1.27]
 .XX ± .010[.254]
 .XXX ± .005[.127]
 L ± .5"
 FRACTIONS ± 1/64[.397]
 FINISH: 125-√RMS



TITLE
**INSTALLATION DRAWING
 YZ SYSTEMS
 Z-100 CONTROLLER**

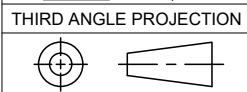

DO NOT SCALE DRAWING	SIZE A	DRAWING NO 2E-0042	REV 00
		SCALE 1 : 1	SHEET 1 of 4

EAR STATEMENT WARNING - This document or file contains technical data the export of which is, or may be, restricted by the Export Administration Act and the Export Administration Regulations (EAR), 15 C.F.R., parts 730-774. Diversion contrary to U.S. law is prohibited. The export, re-export, transfer or re-transfer of this technical data to any other company, entity, person, or destination, or for any use of purpose other than that for which the technical data was originally provided by Milton Roy, is prohibited without prior written approval from Milton Roy and authorization under applicable export control laws. EAR Export Classification: ECCN EAR99.

APPENDIX A: ILLUSTRATIONS

Z-100 Installation Drawing



Z-100 ELECTRONIC CONTROLLER HAZARDOUS AREA INSTALLATION INSTRUCTIONS AND DRAWINGS

WARNING: Substitution of components may impair intrinsic safety.
AVERTISSEMENT: La substitution de composants peut compromettre la sécurité intrinsèque.

WARNING: Explosion Hazard - To prevent ignition of an explosion atmosphere remove power before disconnecting any equipment or wiring unless the area is known to be non-hazardous.

AVERTISSEMENT: Risque d'explosion - Pour éviter l'inflammation d'une atmosphère d'explosion, coupez l'alimentation avant de déconnecter tout équipement ou câblage, à moins que la zone ne soit connue pour être non dangereuse.

WARNING: Replace removable fuses with the same type and rating to provide protection against the risk of fire and shock.

AVERTISSEMENT: Remplacez les fusibles amovibles avec le même type et les mêmes caractéristiques pour vous protéger contre les risques d'incendie et de choc.

WARNING: If battery powered, use only YZ Systems replaceable battery pack assembly, Part Number: E3-2005

AVERTISSEMENT: Si alimenté par batterie, utilisez uniquement l'ensemble de batterie remplaçable YZ Systems, numéro de pièce : E3-2005.

WARNING: F2-0615 Z-100 Controller contains lithium primary battery (VBAT1) under encapsulation. Unit may explode if mistreated. Do Not Recharge, Disassemble or Dispose of in fire.

AVERTISSEMENT: Le contrôleur F2-0615 Z-100 contient une batterie primaire au lithium (VBAT1) sous encapsulation. L'appareil peut exploser s'il est maltraité. Ne pas recharger, démonter ou jeter au feu.

WARNING: POTENTIAL STATIC CHARGING HAZARD - To avoid static buildup, use a damp cloth to clean all painted or other non-metallic surfaces.

AVERTISSEMENT: RISQUE DE CHARGE STATIQUE POTENTIEL - Pour éviter l'accumulation d'électricité statique, utilisez un chiffon humide pour nettoyer toutes les surfaces peintes ou non métalliques.

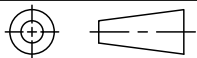
COPYRIGHT © MILTON ROY, LLC THIS DOCUMENT IS THE PROPERTY OF MILTON ROY (MR). YOU MAY NOT POSSESS, USE, COPY OR DISCLOSE THIS DOCUMENT OR ANY INFORMATION IN IT, FOR ANY PURPOSE, INCLUDING WITHOUT LIMITATION TO DESIGN, MANUFACTURE OR REPAIR PARTS, OR OBTAIN ANY GOVERNMENT APPROVAL TO DO SO, WITHOUT MR'S EXPRESS WRITTEN PERMISSION. NEITHER RECEIPT NOR POSSESSION OF THIS DOCUMENT ALONE, FROM ANY SOURCE, CONSTITUTES SUCH PERMISSION. POSSESSION, USE, COPYING OR DISCLOSURE BY ANYONE WITHOUT MR'S EXPRESS WRITTEN PERMISSION IS NOT AUTHORIZED AND MAY RESULT IN CRIMINAL AND/OR CIVIL LIABILITY.	UNLESS OTHERWISE SPECIFIED: DIMENSIONS ARE INCH[mm] INTERPRET DIM AND TOL PER ASME Y14.5-2009 TOLERANCES: X ± .050[1.27] .XX ± .010[.254] .XXX ± .005[.127] ∠ ± .5° FRACTIONS ± 1/64[.397] FINISH: 125-√RMS	 www.miltonroy-americas.com MILTON ROY, LLC							
	TITLE INSTALLATION DRAWING YZ SYSTEMS Z-100 CONTROLLER								
THIRD ANGLE PROJECTION 	DO NOT SCALE DRAWING	SIZE A	<table border="1"> <tr> <td>DRAWING NO</td> <td>REV</td> </tr> <tr> <td>2E-0042</td> <td>00</td> </tr> <tr> <td>SCALE 1 : 1</td> <td>SHEET 2 of 4</td> </tr> </table>	DRAWING NO	REV	2E-0042	00	SCALE 1 : 1	SHEET 2 of 4
DRAWING NO	REV								
2E-0042	00								
SCALE 1 : 1	SHEET 2 of 4								
EAR STATEMENT WARNING - This document or file contains technical data the export of which is, or may be, restricted by the Export Administration Act and the Export Administration Regulations (EAR), 15 C.F.R., parts 730-774. Diversion contrary to U.S. law is prohibited. The export, re-export, transfer or re-transfer of this technical data to any other company, entity, person, or destination, or for any use or purpose other than that for which the technical data was originally provided by Milton Roy, is prohibited without prior written approval from Milton Roy and authorization under applicable export control laws. EAR Export Classification: ECCN EAR99.									



APPENDIX A: ILLUSTRATIONS

Z-100 Installation Drawing



HAZARDOUS AREA INSTALLATION INSTRUCTIONS AND DRAWINGS

Conditions for safe use:

The system shall not be connected to any associated apparatus which uses or generates more than 250VRMS.

Installations:

USA - Installations shall be in accordance with the National Electric Code (NEC), NFPA-70, and ANSI/ISA-RP1206.1

Canada - Installation shall be in accordance with Canadian Electrical Code (CEC) Part 1 (CSA22.1).

ATEX/IECEx - Installations shall be in accordance with all applicable local and national electrical codes, EN60079-14, IEC60079-25, and all Essential Health and Safety Regulations of Directive 2014/34/EU.

Z-100 Controller Assembly F2-0615 is rated and shall be marked as follows:

Z-100 Controller

Ex ia IIB T4 Ga

II 1 G Ex ia IIB T4 Ga

Class I, Zone 0, AEx ia IIB T4 Ga

Class I Division 1, Groups C-D, T4

NOTES:

1. INTRINSICALLY SAFE INTERCONNECT WIRING BETWEEN DEVICES SHOWN MAY BE FACTORY INSTALLED.
2. SUBSTITUTION OF COMPONENTS COULD IMPAIR INTRINSIC SAFETY.
3. CABLE(S) X SHALL BE SHIELDED TWISTED PAIR TYPE. CABLE SHIELDS SHALL BE EARTHED PER 60079-14 IN NON-HAZARDOUS AREA.
4. WHEN USING MULTI-CORE TYPE CABLE(S) FOR CABLE X THE CABLE SHALL BE TYPE A OR B PER 60079-25 CLAUSE 9.
5. IF USING DIODE SAFETY BARRIERS, FOLLOW MANUFACTURERS INSTALLATION INSTRUCTIONS FOR PROPER SAFETY GROUNDING TO PROTECTIVE EARTH.
6. ANALOG FLOW INPUT (TB2) AND COUNT INPUT (TB2) SHALL NOT BE CONNECTED AT THE SAME TIME.
7. INTRINSIC SAFETY BARRIERS OR ISOLATORS SHALL BE COMPLIANT WITH THE SAFETY PARAMETERS LISTED FOR EACH INPUT OR OUTPUT.
8. THE AMBIENT TEMPERATURE RANGE FOR F2-0615 IS -20C TO +60C.
9. F2-0615 INTRINSIC SAFETY PROTECTION LEVEL IS: "ia".
10. EXTERNAL I.S. SUPPLY AND BATTERY PACK E3-2005 SHALL NOT BE CONNECTED AT THE SAME TIME.
11. REPLACEABLE INTRINSICALLY SAFE BATTERY PACK ASSEMBLY, E3-2005, CONTAINS LITHIUM PRIMARY CELLS. DO NOT STORE OR USE IN TEMPERATURES EXCEEDING 85C. DO NOT CHARGE, DISASSEMBLE, OR INCINERATE. DEPLETED BATTERY PACKS SHOULD BE DISPOSED OF PER LOCAL REGULATIONS.
12. ALTHOUGH RECOMMENDED TO VERIFY THE AREA IS SAFE, THE E3-2005 BATTERY PACK MAY BE REPLACED SAFELY IN A HAZARDOUS AREA. REPLACE ONLY WITH YZ PN: E3-2005 INTRINSICALLY SAFE BATTERY PACK ONLY, **SUBSTITUTION OF COMPONENTS MAY IMPAIR INTRINSIC SAFETY.**
13. MM-100 MEMORY MODULE ASSEMBLY F2-0268 IS NOT NORMALLY CONNECTED TO THE CONTROLLER. TO PREVENT POTENTIAL DAMAGE OR SYSTEM RESETS WHEN MEMORY MODULE IS NOT IN USE, COVER THE CONTROLLER CONNECTOR WITH PROVIDED SEAL. SHORT CIRCUITS OR ESD DISCHARGE TO THESE CONNECTIONS COULD RESET OR DAMAGE THE CONTROLLER.
14. Z-100 CONTROLLER IS INTENDED FOR FIXED INSTALLATION.
15. Z-100 CONTROLLER F2-0615 SHALL BE MOUNTED IN AN ENCLOSURE WITH A MINIMUM IP54 RATING IN SYSTEM LEVEL OR FINAL INSTALLATION.
16. MATERIAL USED IN Z-100 COVER PLATE IS ALUMINUM WHICH EXCEEDS 10% IN TOTAL. PLEASE SEE APPLICABLE SYSTEM LEVEL USER MANUAL FOR INSTRUCTIONS TO AVOID IGNITION HAZARD DUE TO IMPACT OR FRICTION.
17. **SCHEDULE DRAWING - DO NOT MODIFY WITHOUT AGENCY APPROVAL.**



COPYRIGHT © MILTON ROY, LLC THIS DOCUMENT IS THE PROPERTY OF MILTON ROY (MR). YOU MAY NOT POSSESS, USE, COPY OR DISCLOSE THIS DOCUMENT OR ANY INFORMATION IN IT, FOR ANY PURPOSE, INCLUDING WITHOUT LIMITATION TO DESIGN, MANUFACTURE OR REPAIR PARTS, OR OBTAIN ANY GOVERNMENT APPROVAL TO DO SO, WITHOUT MR'S EXPRESS WRITTEN PERMISSION. NEITHER RECEIPT NOR POSSESSION OF THIS DOCUMENT ALONE, FROM ANY SOURCE, CONSTITUTES SUCH PERMISSION. POSSESSION, USE, COPYING OR DISCLOSURE BY ANYONE WITHOUT MR'S EXPRESS WRITTEN PERMISSION IS NOT AUTHORIZED AND MAY RESULT IN CRIMINAL AND/OR CIVIL LIABILITY.	UNLESS OTHERWISE SPECIFIED: DIMENSIONS ARE INCH[mm] INTERPRET DIM AND TOL PER ASME Y14.5-2009 TOLERANCES: X ± .050[1.27] .XX ± .010[.254] .XXX ± .005[.127] L ± .5° FRACTIONS ± 1/64[.397] FINISH: 125-√RMS	 www.miltonroy-americas.com MILTON ROY, LLC	
	TITLE INSTALLATION DRAWING YZ SYSTEMS Z-100 CONTROLLER		
THIRD ANGLE PROJECTION 	DO NOT SCALE DRAWING	SIZE A	DRAWING NO 2E-0042 SCALE 1 : 1 SHEET 3 of 4
REV 00			
EAR STATEMENT WARNING - This document or file contains technical data the export of which is, or may be, restricted by the Export Administration Act and the Export Administration Regulations (EAR), 15 C.F.R., parts 730-774. Diversion contrary to U.S. law is prohibited. The export, re-export, transfer or re-transfer of this technical data to any other company, entity, person, or destination, or for any use or purpose other than that for which the technical data was originally provided by Milton Roy, is prohibited without prior written approval from Milton Roy and authorization under applicable export control laws. EAR Export Classification: ECCN EAR99.			



APPENDIX A: ILLUSTRATIONS

Z-100 Installation Drawing

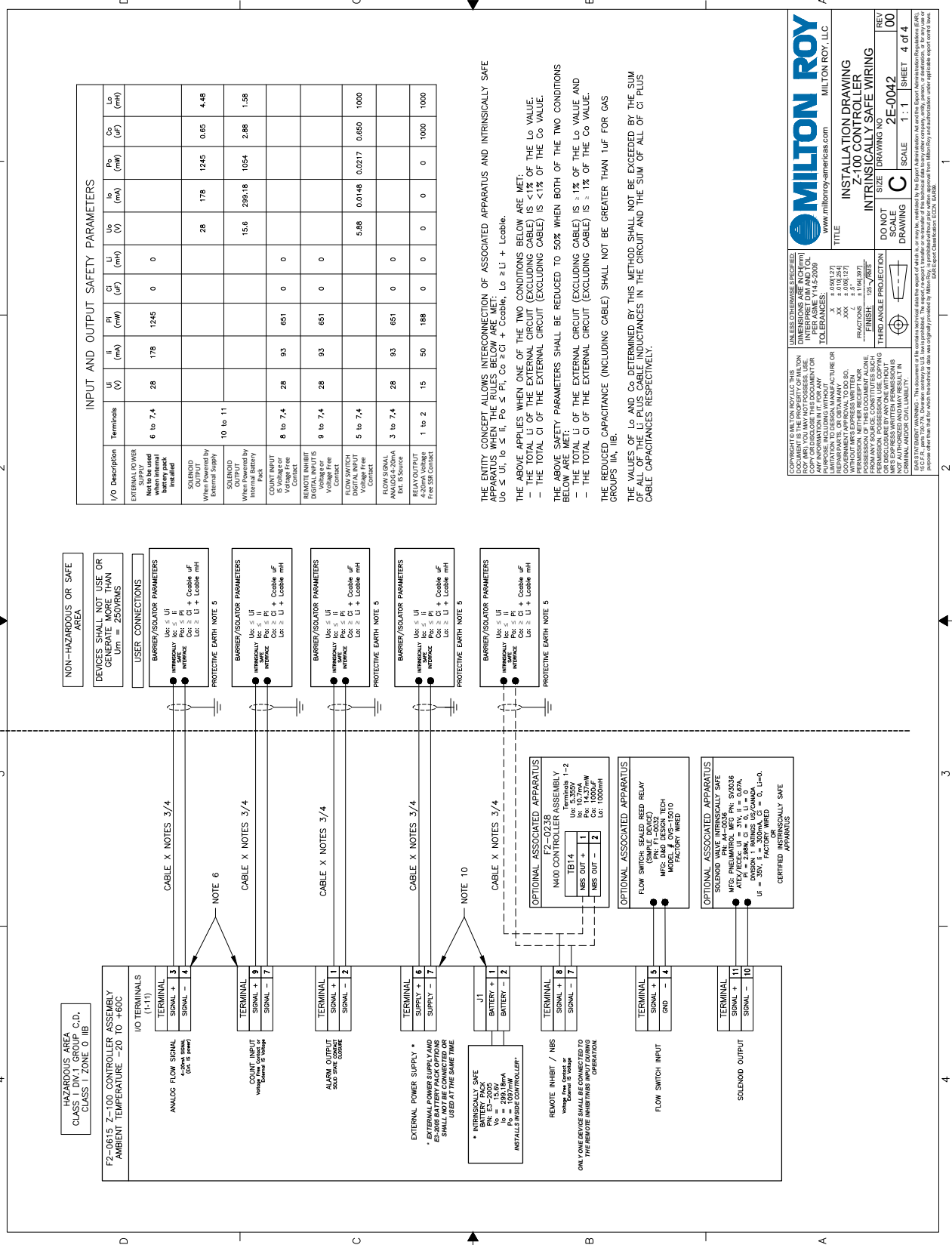

I/O Description	Terminals	Ui (V)	Ii (mA)	Pi (mW)	Ci (uF)	Li (mH)	Uo (V)	Io (mA)	Po (mW)	Co (uF)	Lo (mH)
EXTERNAL POWER 4-20mA SIGNAL Not to be used when internal power source is installed	6 to 7, 4	28	178	1245	0	0	28	178	1245	0.65	4.48
SOLENOID When Powered by External Supply	10 to 11						15.6	299.18	1054	2.88	1.58
INTERNAL BATTERY											
COUNTERMOUNT 5 Voltage Free	8 to 7, 4	28	93	651	0	0					
REMOTE INHIBIT DIGITAL INPUTS Voltage Free	9 to 7, 4	28	93	651	0	0					
FLOW SWITCH Voltage Free	5 to 7, 4						5.88	0.0148	0.0217	0.650	1000
ALARM SIGNAL 4-20mA Voltage Ext. 5-Source	3 to 7, 4	28	93	651	0	0					
RELAY OUTPUT 1 to 2	15	15	50	188	0	0	0	0	0	0	1000

THE ENTITY CONCEPT ALLOWS INTERCONNECTION OF ASSOCIATED APPARATUS AND INTRINSICALLY SAFE APPARATUS WHEN THE RULES BELOW ARE MET:
 Uo ≤ Ui, Io ≤ Ii, Po ≤ Pi, Co ≥ Ci + Cobble, Lo ≥ Li + Lcable.

THE ABOVE APPLIES WHEN ONE OF THE TWO CONDITIONS BELOW ARE MET:
 - THE TOTAL LI OF THE EXTERNAL CIRCUIT (EXCLUDING CABLE) IS < 1% OF THE Lo VALUE.
 - THE TOTAL CI OF THE EXTERNAL CIRCUIT (EXCLUDING CABLE) IS < 1% OF THE Co VALUE.

THE ABOVE SAFETY PARAMETERS SHALL BE REDUCED TO 50% WHEN BOTH OF THE TWO CONDITIONS BELOW ARE MET:
 - THE TOTAL LI OF THE EXTERNAL CIRCUIT (EXCLUDING CABLE) IS ≥ 1% OF THE Lo VALUE AND
 - THE TOTAL CI OF THE EXTERNAL CIRCUIT (EXCLUDING CABLE) IS ≥ 1% OF THE Co VALUE.

THE REDUCED CAPACITANCE (INCLUDING CABLE) SHALL NOT BE GREATER THAN 1uF FOR GAS GROUPS IIA, IIB.

THE VALUES OF Lo AND Co DETERMINED BY THIS METHOD SHALL NOT BE EXCEEDED BY THE SUM OF ALL OF THE Li PLUS CABLE INDUCTANCES IN THE CIRCUIT AND THE SUM OF ALL OF Cj PLUS CABLE CAPACITANCES RESPECTIVELY.

MILTON ROY
MILTON ROY, LLC
www.miltonroy-americas.com

INSTALLATION DRAWING
Z-100 CONTROLLER
INTRINSICALLY SAFE WIRING

DO NOT SCALE DRAWING
SCALE 1:1 SHEET 4 of 4

REV 100
SCALE 2E-0042

REVISIONS:
 X # 0081271
 XXX # 0081271
 # 10463971
 FINISH: USE WIRE

THIRD ANGLE PROJECTION

USE THESE DIMENSIONS UNLESS OTHERWISE SPECIFIED. DIMENSIONS ARE IN MILLIMETERS UNLESS OTHERWISE NOTED. DIMENSIONS ARE TO CENTER UNLESS OTHERWISE NOTED. DIMENSIONS ARE TO FACE UNLESS OTHERWISE NOTED. DIMENSIONS ARE TO HOLE UNLESS OTHERWISE NOTED. DIMENSIONS ARE TO CENTER UNLESS OTHERWISE NOTED. DIMENSIONS ARE TO FACE UNLESS OTHERWISE NOTED. DIMENSIONS ARE TO HOLE UNLESS OTHERWISE NOTED.

FOR INFORMATION ONLY: THIS DOCUMENT IS THE PROPERTY OF MILTON ROY. IT IS TO BE USED ONLY FOR THE PROJECT AND NOT TO BE REPRODUCED OR COPIED FOR ANY OTHER PURPOSE. ANY INFORMATION IN THIS DOCUMENT IS NOT TO BE USED FOR ANY OTHER PURPOSE. ANY INFORMATION IN THIS DOCUMENT IS NOT TO BE USED FOR ANY OTHER PURPOSE. ANY INFORMATION IN THIS DOCUMENT IS NOT TO BE USED FOR ANY OTHER PURPOSE.

DESIGN BY: BARRY W. WATKINS
 DRAWN BY: BARRY W. WATKINS
 CHECKED BY: BARRY W. WATKINS
 APPROVED BY: BARRY W. WATKINS

APPENDIX A: ILLUSTRATIONS

Wiring Control Document

YZ SYSTEMS - SYSTEM LEVEL WIRING CONTROL DOCUMENT SYSTEMS USING Z-100 CONTROLLER

THIS WIRING CONTROL DOCUMENT COVERS THE FOLLOWING YZ SYSTEMS PRODUCT LINES USING THE Z-100 CONTROLLER:
LVO LOW VOLUME ODORIZER 610G OR 610F
DYNAPAK 20X0, 30X0
CYCLONE MLS-4400

THE SYSTEMS LISTED ABOVE HOLD THE FOLLOWING APPROVALS:

CLASS I, DIVISION 1, GROUPS C-D, T4
PROVIDES INTRINSICALLY SAFE OUTPUTS FOR CLASS I, DIVISION 1, GROUPS C-D AND CLASS I, ZONE 0, GROUP IIB
CLASS I, ZONE 0, AEx ia [ia] IIB T4 Gg

Ex h ia [ia] IIB T4 Gg
Ex ia [ia] IIB T4 Gg
Ex ia [ia] IIB T4 Gg
IP54

ETL23CA I04230006X
IECEX ETL 23.001 3X
ETL24ATEX0290X
IIS24UKEX0707X

Comforms to UL STD 60079-0, 60079-1, 61010-1, 80079-36, 80079-37
Comforms to CSA STD C22.2 NO. 60079-0, 60079-1, 61010-1-12, 80079-36, 80079-37

INTRINSICALLY SAFE
INTRINSICALLY SAFE
INTRINSICALLY SAFE

SPECIAL CONDITIONS OF USE
FOR SYSTEMS NOT INTENDED FOR FIXED INSTALLATION
2. POTENTIAL ELECTROSTATIC CHARGING HAZARD. EQUIPMENT SHALL BE CLEANED WITH A DAMP CLOTH.

SYSTEM DETAILS

ITEM	DESCRIPTION	ASSEMBLY
1	LVO VALVE	VALVE PKG.
2	TANK	SEE TABLE ABOVE
3	Z-100 CONTROLLER	SEE TABLE ABOVE
4	FLOW SWITCH (OPTIONAL)	SEE TABLE ABOVE

Z-100 CONTROLLER

External U.S. Supply
UL: 28VDC
Ii: 178mA
Pi: 1.245W

Internal Battery Pack
UL: 15.6VDC
Ii: 299, 18mA
Pi: 1.054W

Z-100 CONTROLLER
IECEX ETL 22.001 3X
ETL22ATEX0132X
IIS22UKEX0366X
ETL22CA I04230006X

SOLENOID
50mA @ 12VDC
NOMINAL
IECEX CML 17.0030X
CML 17ATEX046X
CML 21UKEX2706X
FM 3028 180C
FM 3020332

FLOW SWITCH
(LVO 610F MODELS ONLY)

PUMPS
LVO 6000 SERIES
DYNAPAK 2000 AND 3000 SERIES
CYCLONE MLS-4400
IECEX ETL 24.0005X
ETL24ATEX0371 X
IIS24UKEX0799X

SOLENOID
DYNAPAK SYSTEM

SOLENOID
CYCLONE SYSTEM

SYSTEM LEVEL CONNECTIONS
MADE AT Z-100 CONTROLLER:

1. RELAY +
2. RELAY -
3. ANALOG IN
4. COMMON
5. FLOW SWITCH
6. EXT. POWER
7. COMMON
8. NBS IN
9. COUNT IN
10. SOLENOID -
11. SOLENOID +

Z-100 CONTROLLER
INTRINSICALLY SAFE
EXHAUSTIVE LIST OF CONNECTIONS

1 2 3 4 5 6 7 8 9 10 11

ON OFF

FOR EXHAUSTIVE LIST OF CONNECTIONS FOR EACH SYSTEM, REFER TO THE MODEL CODE ABOVE FOR ALL MODELS COVERED UNDER THIS DOCUMENT.

NOTES:

1. EX. SCHEDULE DRIVING - DO NOT MODIFY WITHOUT AGENCY APPROVAL.
2. X-CONDITION: MUST ENSURE THAT THE PROCESS GAS USED FOR PUMP ACTUATION IS OXYGEN FREE.
3. ASSEMBLIES SHOWN DO NOT COVER ALL CONFIGURATIONS FOR EACH PRODUCT LINE. REFER TO THE MODEL CODE ABOVE FOR ALL MODELS COVERED UNDER THIS DOCUMENT.
4. SEE WIRING CONTROL DOCUMENT 2E-0042 FOR ALL WIRING AND APPROVALS INFORMATION ON THE Z-100 CONTROLLER.

DATE	ECN	DESCRIPTION	APPROVED	REVISION
4/9/2024	30438	UPDATED RATINGS FOR IAC CERTIFICATION	CIC	TR4 02
11/20/2023	30040	ADDED TABLE WITH OVERALL LVO TANK & VALVE RATINGS	CIC	TR4 01
7/6/2023	29589	INITIAL RELEASE	TR4	SS 00

LINEAR DIMENSIONS - DIMENSIONS LINEAR (INCHES)	MIN	TYP	MAX
3.4	±0.000	±0.001	±0.002
3.6	±0.000	±0.001	±0.002
3.8	±0.000	±0.001	±0.002
4.0	±0.000	±0.001	±0.002
4.2	±0.000	±0.001	±0.002
4.4	±0.000	±0.001	±0.002
4.6	±0.000	±0.001	±0.002
4.8	±0.000	±0.001	±0.002
5.0	±0.000	±0.001	±0.002
5.2	±0.000	±0.001	±0.002
5.4	±0.000	±0.001	±0.002
5.6	±0.000	±0.001	±0.002
5.8	±0.000	±0.001	±0.002
6.0	±0.000	±0.001	±0.002
6.2	±0.000	±0.001	±0.002
6.4	±0.000	±0.001	±0.002
6.6	±0.000	±0.001	±0.002
6.8	±0.000	±0.001	±0.002
7.0	±0.000	±0.001	±0.002
7.2	±0.000	±0.001	±0.002
7.4	±0.000	±0.001	±0.002
7.6	±0.000	±0.001	±0.002
7.8	±0.000	±0.001	±0.002
8.0	±0.000	±0.001	±0.002
8.2	±0.000	±0.001	±0.002
8.4	±0.000	±0.001	±0.002
8.6	±0.000	±0.001	±0.002
8.8	±0.000	±0.001	±0.002
9.0	±0.000	±0.001	±0.002
9.2	±0.000	±0.001	±0.002
9.4	±0.000	±0.001	±0.002
9.6	±0.000	±0.001	±0.002
9.8	±0.000	±0.001	±0.002
10.0	±0.000	±0.001	±0.002
10.2	±0.000	±0.001	±0.002
10.4	±0.000	±0.001	±0.002
10.6	±0.000	±0.001	±0.002
10.8	±0.000	±0.001	±0.002
11.0	±0.000	±0.001	±0.002



WIRING CONTROL DOCUMENT
LVO, DP, CYCLONE SYSTEMS

THIRD PARTY PRODUCTION
DRAWING NUMBER - PLAN#
2E-0054

REVISIONS
REV 02

APPENDIX A: ILLUSTRATIONS

Wiring Control Document

LVO LOW VOLUME ODORIZER 610G OR 610F SYSTEM NOTES:

- FLOODED SUCTION REQUIRED FOR PRIMING.
- SHALL NOT BE USED WITHOUT A PROCESS MEDIUM.
- COMPATIBLE FLUIDS: GROUP IIC GASES AND NATURAL GAS ODORANTS (VARIOUS BLENDS)
- INLET ACTIVATION PRESSURE: 30 - 60 psf
- OPERATING SYSTEM TEMPERATURE: -4°F to +140°F (20°C to +60°C)
- INSTALLATION INSTRUCTIONS:
 - SYSTEM SHALL BE MOUNTED IN A VERTICAL POSITION.
 - ATTACH SYSTEM TO A SECTION OF PIPE USING PROVIDED MOUNTING CLAMPS.
 - CONNECT A GROUND WIRE FROM THE 2" PIPE TO A PROPERLY INSTALLED GROUND ROD.
 - CONNECT THE PUMP DISCHARGE VALVE FITTING TO THE PIPELINE CONNECTION.
 - PRESSURE TEST SYSTEM PRIOR TO TURNING ON.
- MAINTENANCE:
 - SEE TABLE BELOW
 - SEE FULL SYSTEM LEVEL MANUAL FOR TROUBLESHOOTING STEPS
- REPAIR:
 - SYSTEM SHALL BE PURGED AND VENTED PRIOR TO SERVICING
 - SYSTEM SHALL HAVE POWER DISCONNECTED PRIOR TO SERVICING
 - PRESSURE TEST SYSTEM AFTER SERVICING

DYNAPAK 20X0, 30X0 SYSTEM NOTES:

- FLOODED SUCTION REQUIRED FOR PRIMING.
- SHALL NOT BE USED WITHOUT A PROCESS MEDIUM
- COMPATIBLE FLUIDS: GROUP IIC GASES, ODORIZED OR UNODORIZED
- INLET ACTIVATION PRESSURE: 50 - 65 psf
- OPERATING SYSTEM TEMPERATURE: -4°F to +140°F (20°C to +60°C)
- INSTALLATION INSTRUCTIONS:
 - MINIMUM OF FIVE PIPE DIAMETERS FROM ANY DEVICE.
 - SYSTEM SHOULD BE MOUNTED VERTICALLY IN A HORIZONTAL RUN OF THE PIPELINE.
 - SUCTION: REQUIRES 1/2" OR 3/4" FNPT PIPELINE CONNECTION DEPENDING ON MODEL.
 - END OF SAMPLER PROBE SHOULD PENETRATE THE CENTER 1/3RD OF THE PIPELINE.
 - DISCHARGE: 1/8" NPT PIPELINE CONNECTION PORT ALONG WITH A CHECK VALVE.
 - AFTER APPLYING PIPELINE PRESSURE, CHECK ALL CONNECTIONS USING LIQUID LEAK DETECTOR.
- MAINTENANCE:
 - SEE TABLE BELOW
 - SEE FULL SYSTEM LEVEL MANUAL FOR TROUBLESHOOTING STEPS
- REPAIR:
 - SYSTEM SHALL BE PURGED AND VENTED PRIOR TO SERVICING
 - SYSTEM SHALL HAVE POWER DISCONNECTED PRIOR TO SERVICING
 - PRESSURE TEST SYSTEM AFTER SERVICING

CYCLONE MSL-4400 SYSTEM NOTES:

- FLOODED SUCTION REQUIRED FOR PRIMING.
- SHALL NOT BE USED WITHOUT A PROCESS MEDIUM
- COMPATIBLE FLUIDS: GROUP IIC GASES, CHEMILUBE, ANDEROL, SW OR EQUIVALENT
- INLET ACTIVATION PRESSURE: 15 - 55 psf
- OPERATING SYSTEM TEMPERATURE: -4°F to +140°F (20°C to +60°C)
- INSTALLATION INSTRUCTIONS:
 - SYSTEM SHALL BE MOUNTED IN A VERTICAL POSITION.
 - SUCTION: 1/4" NPT PIPELINE GAS CONNECTION REQUIRED
 - DISCHARGE: 1/8" NPT TUBING TO INJECTION PORT ALONG WITH A CHECK VALVE
 - PRESSURE TEST SYSTEM PRIOR TO TURNING ON
- MAINTENANCE:
 - SEE TABLE BELOW
 - SEE FULL SYSTEM LEVEL MANUAL FOR TROUBLESHOOTING STEPS
- REPAIR:
 - SYSTEM SHALL BE PURGED AND VENTED PRIOR TO SERVICING
 - SYSTEM SHALL HAVE POWER DISCONNECTED PRIOR TO SERVICING
 - PRESSURE TEST SYSTEM AFTER SERVICING

LVO 610G OR 610F MAINTENANCE SCHEDULE	
ITEM	INTERVAL
VERIFY GAS PRESSURES	EVERY WEEK
CHECK FOR GAS & ODORANT LEAKS	EVERY WEEK
VISUALLY INSPECT FOR OBVIOUS EXTERNAL PROBLEMS	EVERY WEEK
INSPECT OVERFLOW PROTECTOR & SERVICE AS NEEDED	EVERY 6-MONTHS
INSPECT TUBE FITTINGS AND VALVE PACKINGS FOR LEAKS	EVERY 6-MONTHS
REBUILD PUMP	EVERY 12-MONTHS
REPLACE O-RINGS	EVERY 12-MONTHS
TEST REGULATORS & SERVICE AS NEEDED	EVERY 12-MONTHS
CONDITION ODORANT AS NEEDED	EVERY 12-MONTHS
TEST SYSTEM PERFORMANCE	EVERY 12-MONTHS
REPLACE BATTERY	*EVERY 12-MONTHS

DYNAPAK 20X0, 30X0 MAINTENANCE SCHEDULE	
ITEM	INTERVAL
VERIFY SYSTEM PRESSURE	EVERY MONTH
CHECK FOR LEAKS	EVERY MONTH
TEST BATTERY	EVERY MONTH
CLEAN & LUBRICATE PUMP	EVERY 6-MONTHS
CHECK FILTER ELEMENT & REPLACE IF NEEDED	EVERY 6-MONTHS
REBUILD PUMP	EVERY 12-MONTHS
TEST SYSTEM PERFORMANCE & SERVICE AS NEEDED	EVERY 12-MONTHS
REPLACE BATTERY	EVERY 12-MONTHS

CYCLONE MSL-4400 MAINTENANCE SCHEDULE	
ITEM	INTERVAL
CLEAN & INSPECT INJECTOR PUMP	EVERY 6-MONTHS
CHECK FILTER ELEMENT	EVERY 6-MONTHS
TEST BATTERY	EVERY MONTH

* MORE FREQUENT REPLACEMENT MAY BE REQUIRED IF SYSTEMS RUNS MORE THAN SIX PER HOUR

ENCLOSURE DETAILS

ITEM	OVERALL DIM.	MATERIALS
ENCLOSURE WITH QUICK-RELEASE LATCHES (COMMON) - QTY 2	10.5" L x 6.5" W x 6.3" D	ENCLOSURE: FIBERGLASS HARDWARE: 316 STAINLESS STEEL
LIQUID TIGHT FITTING PLUGS (COMMON) - QTY 2	7/16" OD	RUBBER
MANIFOLD GASKET (LVO)	1.35" W x 2.85" L x .06" T	NITRILE
PUMP GASKET (LVO)	2.55" OD x 1.49" ID x .06" T	RUBBER
TUBING GROMMET (LVO) - QTY 2 (610G), QTY 2 (610F)	1/4" ID x 1/2" GRV DIA x 1/8" GRV W	RUBBER
PIPE GROMMET (DYNAPAK)	3/4" ID x 1/16" GRV DIA x 1/8" GRV W	RUBBER
PUMP GASKET (DYNAPAK)	2" OD x 1.25" ID x .125" T	NEOPRENE
FILTER / REGULATOR GASKET (DYNAPAK & CYCLONE) - QTY 2	2" OD x 1.25" ID x .125" T	NEOPRENE
TUBING GROMMET (DYNAPAK & CYCLONE) - QTY 2	1/8" ID x 5/16" GRV DIA x 1/8" GRV W	BUNA-N
PUMP GASKET (CYCLONE)	1.5" OD x .75" ID x .125" T	RUBBER
RESERVOIR GASKET (CYCLONE)	2" x .125" T	RUBBER

<p>PROPRIETARY NOTICE</p> <p>THE DRAWINGS CONTAINING CONFIDENTIAL AND PROPRIETARY INFORMATION OF YZ SYSTEMS. THE INFORMATION IS TO BE KEPT CONFIDENTIAL AND NOT TO BE REPRODUCED, COPIED, OR DISCLOSED TO ANY OTHER PARTY WITHOUT THE WRITTEN PERMISSION OF YZ SYSTEMS. ANY UNAUTHORIZED USE OR DISCLOSURE OF THIS INFORMATION IS STRICTLY PROHIBITED AND WILL BE PUNISHED TO THE FULL EXTENT OF THE LAW.</p>	
<p>GENERAL TOLERANCES UNLESS SPECIFIED</p> <p>FINISH</p> <p>RA</p> <p>3.2</p>	<p>LINEAR DIMENSIONS - DIMENSIONS LINEAIRES mm(INCHES)</p> <p>3-6 6-30 30-150 150-300 300-600 600-1000 1000-2000 2000-4000</p> <p>+0.0000 +0.0010 +0.0020 +0.0030 +0.0040 +0.0050 +0.0070 +0.0100</p>
<p>DESCRIPTION</p> <p>WIRING CONTROL DOCUMENT</p> <p>LVO, DP, CYCLONE SYSTEMS</p>	
<p>FORMAT</p> <p>THIRD ANGLE PROJECTION</p> <p>SHEET 7 OF 12</p>	
<p>DRAWING NUMBER - PLANT</p> <p>2E-0054</p>	
<p>REV</p> <p>02</p>	

APPENDIX A: ILLUSTRATIONS

Pump Control Document

12345678

ABCDEF

THIS CONTROL DOCUMENT COVERS THE FOLLOWING YZ SYSTEMS PUMPS:

LVO 6000 SERIES
 DYNAPAK 2000 AND 3000 SERIES
 CYCLONE MLS-4400

THE PUMPS LISTED ABOVE HOLD THE FOLLOWING APPROVALS:

Ex h IIC T4 Ga
 Ex II 1 G
 -20°C ≤ Tamb ≤ +60°C

IECEX ETL 24.0005X
 ETL24ATEX0371X
 ITS24UKEX0799X



NOTES:

1.  SCHEDULE DRAWING - DO NOT MODIFY WITHOUT AGENCY APPROVAL.

DATE	30438	INITIAL RELEASE	CJC	TRA	REV
5/17/2024	ECN	DESCRIPTION	Drawn - Dessiné / Visé	Checked - Vérifié / Visé	00
REVISION HISTORY					
GENERAL TOLERANCES	LINEAR DIMENSIONS - DIMENSIONS LINEAIRES mm(INCHES)	FINISH	GEOMETRIC TOLERANCES TOLERANCES GEOMETRIQUES		
ISO 2768	5 - 6 6 - 30 30 - 120 120 - 400 400 - 1000 1000 - 2000 2000 - 4000	Ra	Ra		
TOLERANCES DIMENSIONNELLES	±0.13(0.005) ±0.25(0.010) ±0.38(0.015) ±0.50(0.020) ±0.63(0.025) ±0.75(0.030) ±1.00(0.040)	Ra	Ra		
TOLERANCES DIMENSIONNELLES	±0.13(0.005) ±0.25(0.010) ±0.38(0.015) ±0.50(0.020) ±0.63(0.025) ±0.75(0.030) ±1.00(0.040)	Ra	Ra		
DESCRIPTION					
<p>Ex h PUMP CONTROL DOCUMENT</p> <p>6000, DP, MLS-4400 PUMPS</p>					
THIRD ANGLE PROJECTION	SHEET - FEUILLE	DRAWING NUMBER - PLANNING			
A3	1 / 4	2A-0151			
<p>IMPORTANT NOTICE: THIS DRAWING IS THE PROPERTY OF YZ SYSTEMS. IT IS TO BE USED ONLY FOR THE PROJECT AND SITE SPECIFICALLY IDENTIFIED IN THE DRAWING. IT IS NOT TO BE REPRODUCED, COPIED, OR TRANSMITTED IN ANY MANNER WITHOUT THE WRITTEN PERMISSION OF YZ SYSTEMS. THE INFORMATION CONTAINED HEREIN IS UNCLASSIFIED AND IS NOT TO BE RELEASED TO THE PUBLIC WITHOUT THE WRITTEN PERMISSION OF YZ SYSTEMS. THE INFORMATION CONTAINED HEREIN IS UNCLASSIFIED AND IS NOT TO BE RELEASED TO THE PUBLIC WITHOUT THE WRITTEN PERMISSION OF YZ SYSTEMS.</p>					

APPENDIX A: ILLUSTRATIONS

Pump Control Document

MLS-4400 PUMP

BILL OF MATERIAL - MLS-4400 PUMP		
ITEM NO.	DESCRIPTION	MATERIAL
1	ROLL PIN	18-8 STAINLESS STEEL
2	PUMP PISTON	6061-T6 ALUMINIUM
3	PLUNGER	17-4 STAINLESS STEEL
4	WAFER	VITON
5	ACTION SPRING	316 STAINLESS STEEL
6	ACTION CYL.	6061-T6 ALUMINIUM
7	SEAL RETAINER	316 STAINLESS STEEL
8	LOWER SPRING	316 STAINLESS STEEL
9	PUMP BODY	316 STAINLESS STEEL
10	PLUNGER BUSHING	TEFLON
11	ACTION SEAL	LUBRITHANE W/ VITON
12	O-RING	VITON
13	PUMP SEAL CARTRIDGE	316 STAINLESS STEEL
14	SET SCREW	18-8 STAINLESS STEEL
15	PLUNGER SEAL	VITON
16	O-RING	VITON
17	O-RING	VITON
18	CERTIFICATION LABEL	POLYESTER

PUMP NOTES:

- PUMP CALCULATIONS:**
 - SOLENOID STROKE TIME = 600 ms. MAX PUMP STROKE = 0.76 in
 - PUMP SPEED = 0.76 in / 600 ms = 0.001267 in/ms
 - MAIN SPRING CONSTANT = 1,138,324 N/mm, MAX DISPLACEMENT = 19,304 mm
 - MAIN SPRING ENERGY = $(1/2) * 1,138,324 \text{ N/mm} * 19,304^2 \text{ mm} = 212,0591 \text{ N}$
 - MASS OF PLUNGER = 15.66 g
 - MASS OF MAIN SPRING = 2.86 g
 - MASS OF LOWER SPRING = 0.06 g
- PUMP MAINTENANCE:**
 - RE-LUBRICATION INTERVAL: EVERY 6-MONTHS
 - LUBRICANT TYPE: NON-SOLUBLE ASSEMBLY GREASE
 - ALL LUBRICANTS UTILIZED SHALL HAVE A MINIMUM FLASH POINT OF 120C

RE-LUBRICATION INSTRUCTIONS:

- DISASSEMBLE PUMP
- APPLY LIGHT COAT OF LUBRICANT ON ALL O-RINGS, INSIDE ACTION CYLINDER, AND PLUNGER SEAL
- RE-ASSEMBLE PUMP
- FLOODED SUCTION REQUIRED FOR PRIMING PUMP
- PUMP SHALL NOT BE USED WITHOUT A PROCESS MEDIUM
- PUMP COMPATIBLE FLUIDS: GROUP IIC GASES, CHEMLUBE, ANDEROL, SW OR EQUIVALENT
- MAXIMUM OVERALL MASS: 1.42 lbs
- INLET ACTION PRESSURE: 15 - 55 psi
- MAXIMUM PROCESS PRESSURE: 1500 psi

PROPRIETARY NOTICE
 THIS DRAWING CONTAINS CONFIDENTIAL AND PROPRIETARY INFORMATION. IT IS THE PROPERTY OF YZ SYSTEMS, INC. THE RECIPIENT OF THIS DRAWING AGREES TO MAINTAIN THE CONFIDENTIALITY AND PROPRIETARY NATURE OF THE INFORMATION CONTAINED HEREIN. THE RECIPIENT OF THIS DRAWING AGREES TO ACCEPT THE DRAWING AS CORRECT AND TO HOLD YZ SYSTEMS, INC. HARMLESS FROM ANY AND ALL CLAIMS, DAMAGES, LOSSES, AND EXPENSES, INCLUDING REASONABLE ATTORNEY'S FEES, ARISING OUT OF OR RESULTING FROM THE USE OF THIS DRAWING. THIS DRAWING IS NOT TO BE COPIED, REPRODUCED, OR TRANSMITTED IN ANY FORM OR BY ANY MEANS, WITHOUT THE WRITTEN PERMISSION OF YZ SYSTEMS, INC. THE RECIPIENT OF THIS DRAWING AGREES TO HOLD YZ SYSTEMS, INC. HARMLESS FROM ANY AND ALL CLAIMS, DAMAGES, LOSSES, AND EXPENSES, INCLUDING REASONABLE ATTORNEY'S FEES, ARISING OUT OF OR RESULTING FROM THE USE OF THIS DRAWING. THIS DRAWING IS NOT TO BE COPIED, REPRODUCED, OR TRANSMITTED IN ANY FORM OR BY ANY MEANS, WITHOUT THE WRITTEN PERMISSION OF YZ SYSTEMS, INC. THE RECIPIENT OF THIS DRAWING AGREES TO HOLD YZ SYSTEMS, INC. HARMLESS FROM ANY AND ALL CLAIMS, DAMAGES, LOSSES, AND EXPENSES, INCLUDING REASONABLE ATTORNEY'S FEES, ARISING OUT OF OR RESULTING FROM THE USE OF THIS DRAWING. THIS DRAWING IS NOT TO BE COPIED, REPRODUCED, OR TRANSMITTED IN ANY FORM OR BY ANY MEANS, WITHOUT THE WRITTEN PERMISSION OF YZ SYSTEMS, INC. THE RECIPIENT OF THIS DRAWING AGREES TO HOLD YZ SYSTEMS, INC. HARMLESS FROM ANY AND ALL CLAIMS, DAMAGES, LOSSES, AND EXPENSES, INCLUDING REASONABLE ATTORNEY'S FEES, ARISING OUT OF OR RESULTING FROM THE USE OF THIS DRAWING.



An Ingersoll Rand Business

201 Ivyland Road

Ivyland, PA 18974

P: 281-362-6500

1-800-NJEX-HELP

(1-800-653-9435)

TechSupport@yzsystems.com

www.yzsystems.com